

INDEX

SECTION 1	
• PROFILES	3
Framing beads	3
Panels	10
Edge profiles	36
SECTION 2	
• TRADITIONAL SERIES	45
SECTION 3	
• DISTINCTIVE SERIES	67
SECTION 4	
• CATHEDRAL SERIES	93
SECTION 5	
• APPLIED MOULDING SERIES	113
SECTION 6	
• PRESTIGE SERIES (MITERED DOORS)	119
Profiles	119
Door models	137
SECTION 7	
• WAINSCOTS	199

SECTION 8

• SPECIALITY PRODUCTS 209

Optional glassed frames	209
Peg options	220
Hinge hole options	221
Appliance fronts ***DISCONTINUED***	222
Oven frame	223
Overlay Fillers	226
Rosettes	241
Valances	243
Wood supports	247
Wood posts	261
Half-posts ***DISCONTINUED***	289
Bun feet ***DISCONTINUED***	295
Range hood ***DISCONTINUED***	298
Wine rack	301
Stemware rack	305
Dovetail drawers	306

SECTION 10

• PROMOTIONAL ITEMS 393

SECTION 11

• POLICY 395

Profiles

Standard $\frac{3}{4}$ " framing beads

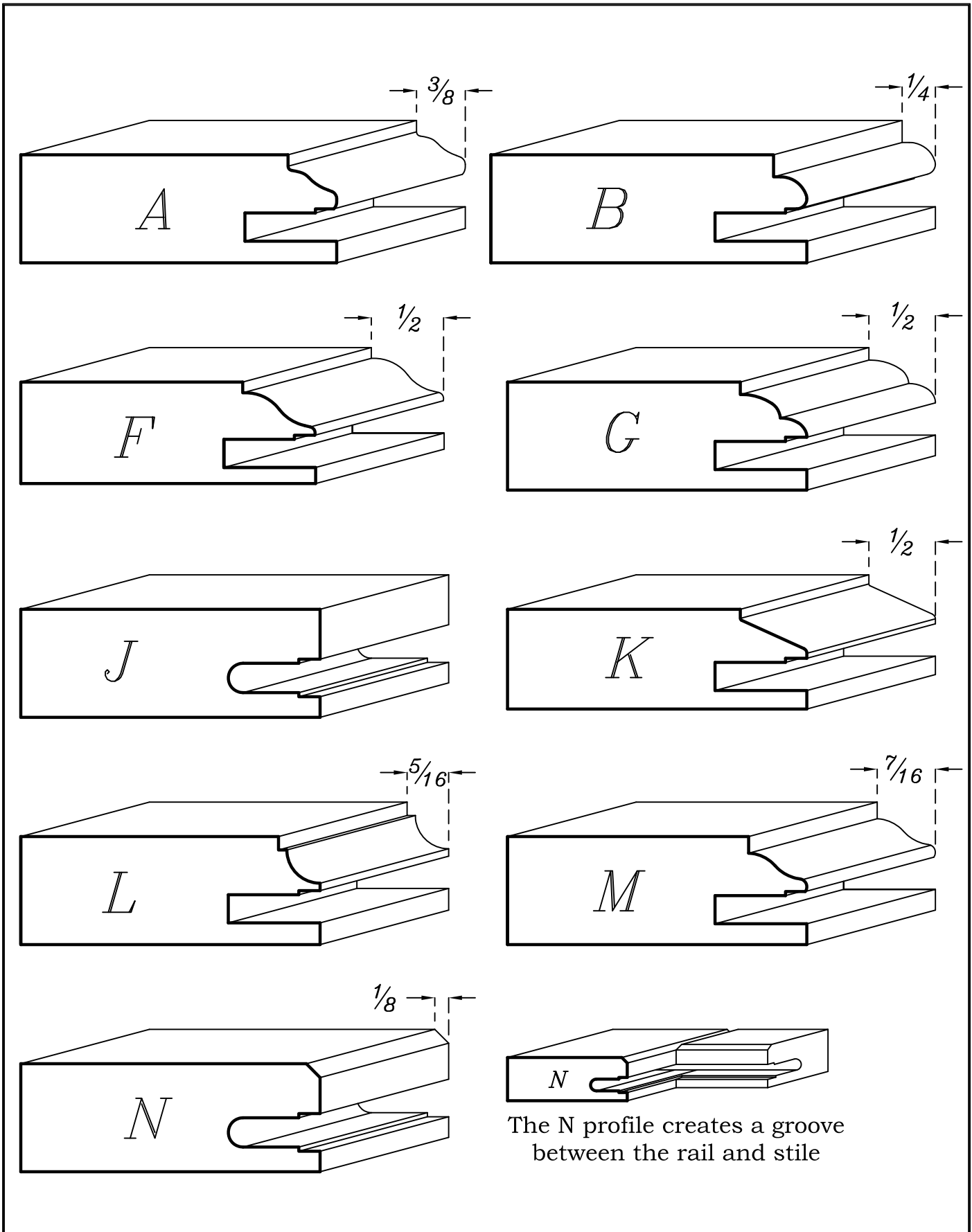

- 1 PROFILES
- 2 TRADITIONAL 90
- 3 DISTINCTIVE 90
- 4 CATHEDRAL 90
- 5 APPLIED MOLDINGS
- 6 PRESTIGE 45
- 7 WAINSCOTS
- 8 SPECIALTY PRODUCTS
- 9 MOLDINGS
- 10 PROMOTIONAL ITEMS
- 11 POLICY

Profiles

Standard 3/4" framing beads

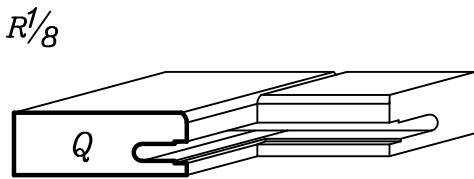
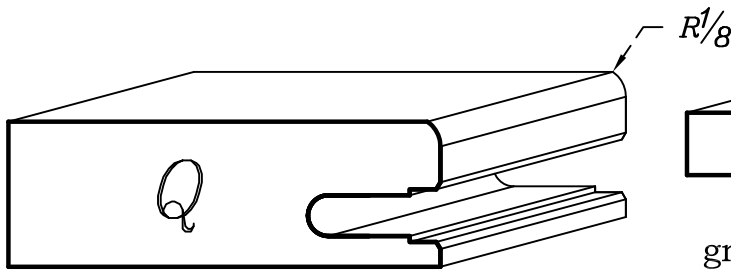
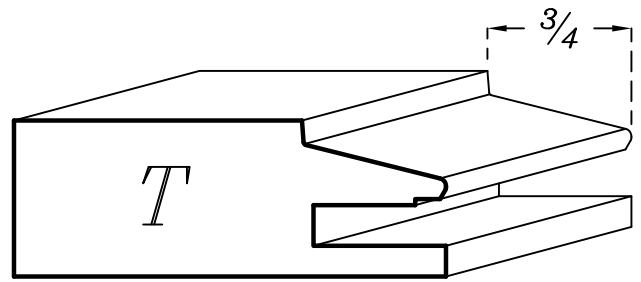
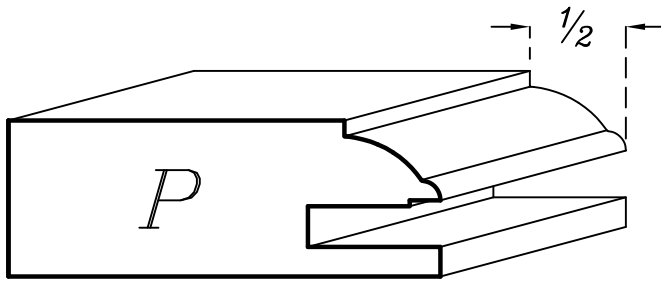

The Q profile creates a groove between the rail and stile

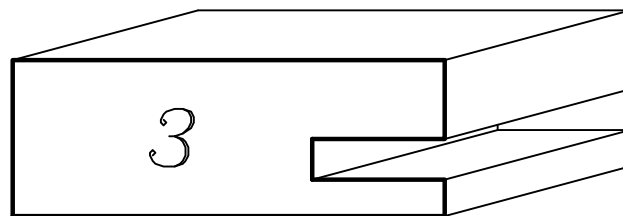
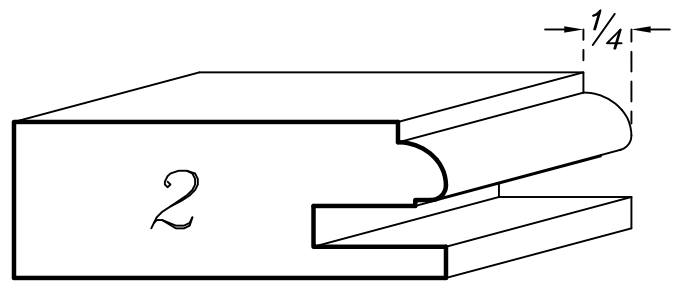
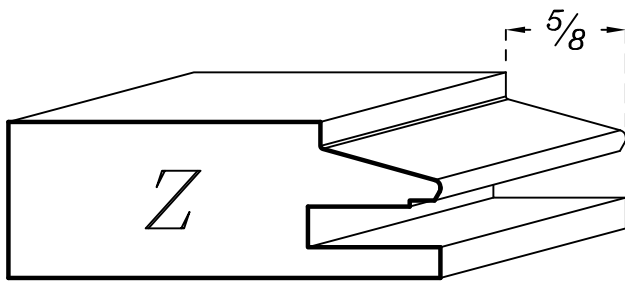
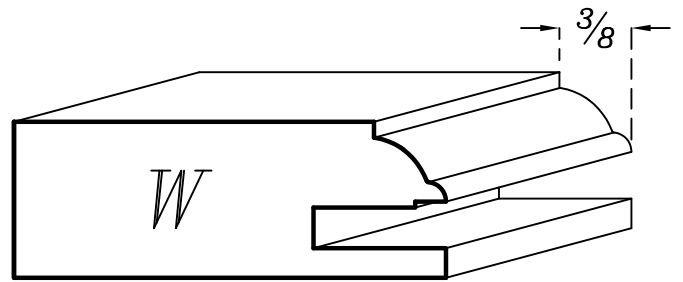
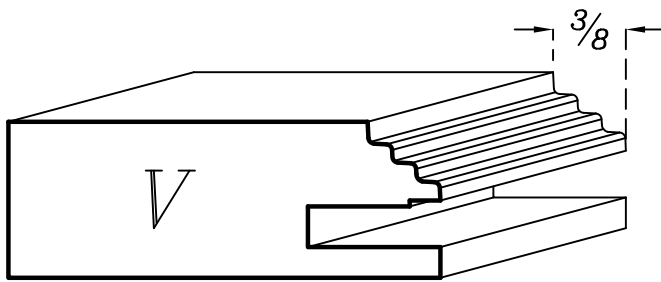

Profiles

Standard $\frac{3}{4}$ " framing beads

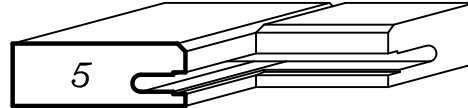
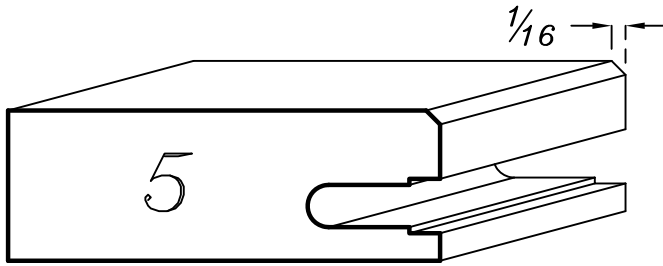

The 5 profile creates a groove between the rail and stile

Profiles

Standard 3/4" framing beads

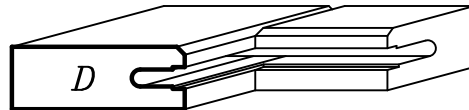
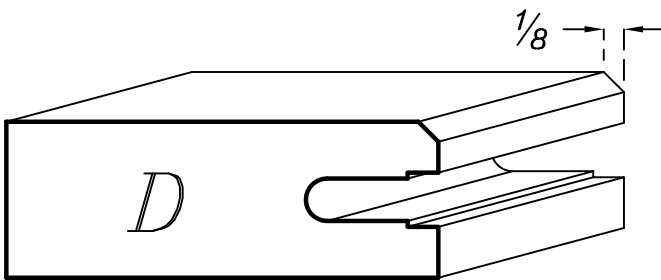
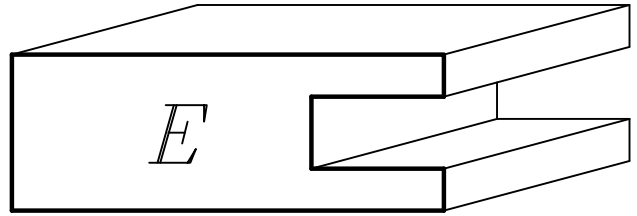
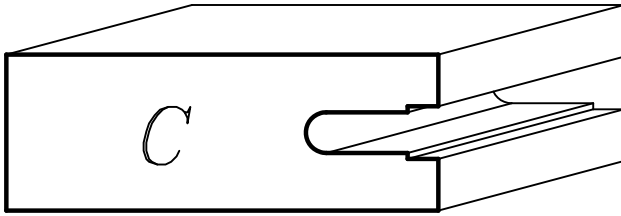

The D profile creates a groove between the rail and stile

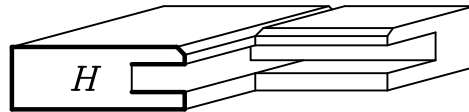
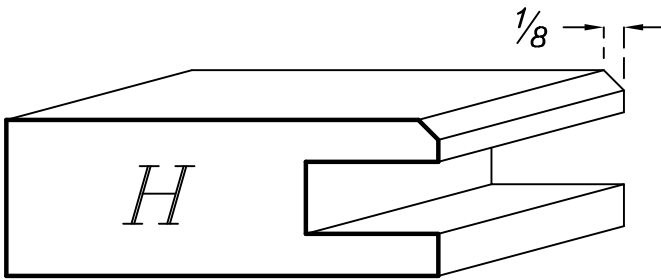

The H profile creates a groove between the rail and stile

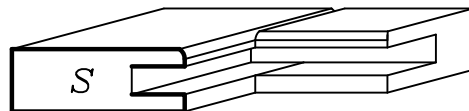
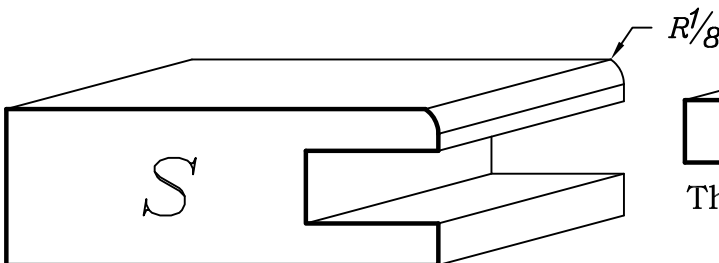
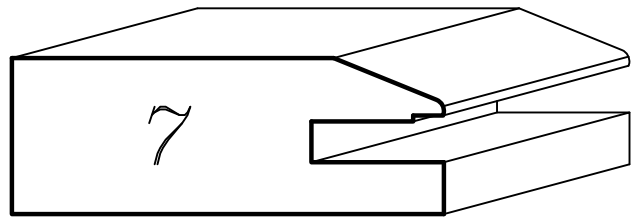
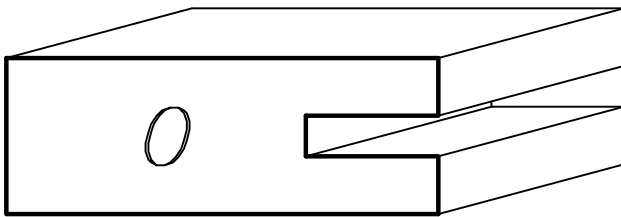

The S profile creates a groove between the rail and stile

Profiles

Standard $\frac{3}{4}$ " framing beads

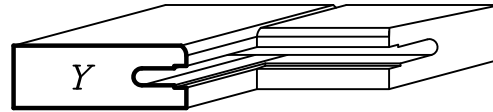
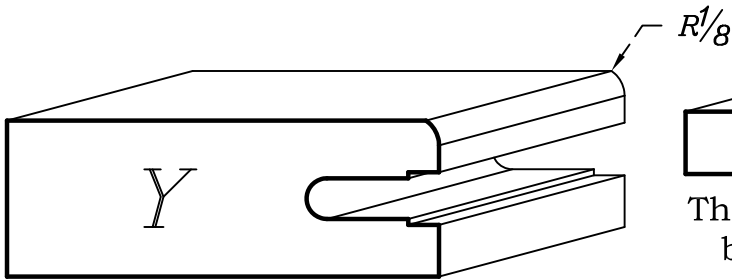

The Y profile creates a groove between the rail and stile

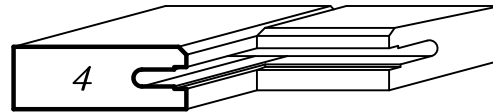
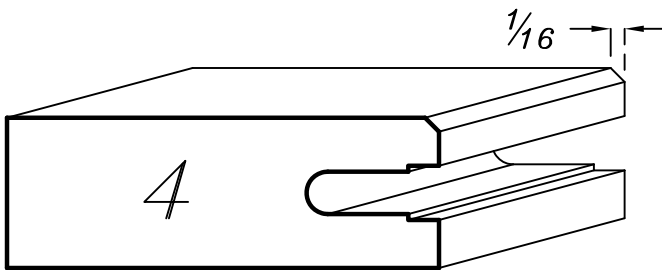

The 4 profile creates a groove between the rail and stile

1	PROFILES
2	TRADITIONAL 90
3	DISTINCTIVE 90
4	CATHEDRAL 90
5	APPLIED MOULDINGS
6	PRESTIGE 45
7	WAINSCOTS
8	SPECIALTY PRODUCTS
9	MOULDINGS
10	PROMOTIONAL ITEMS
11	POLICY

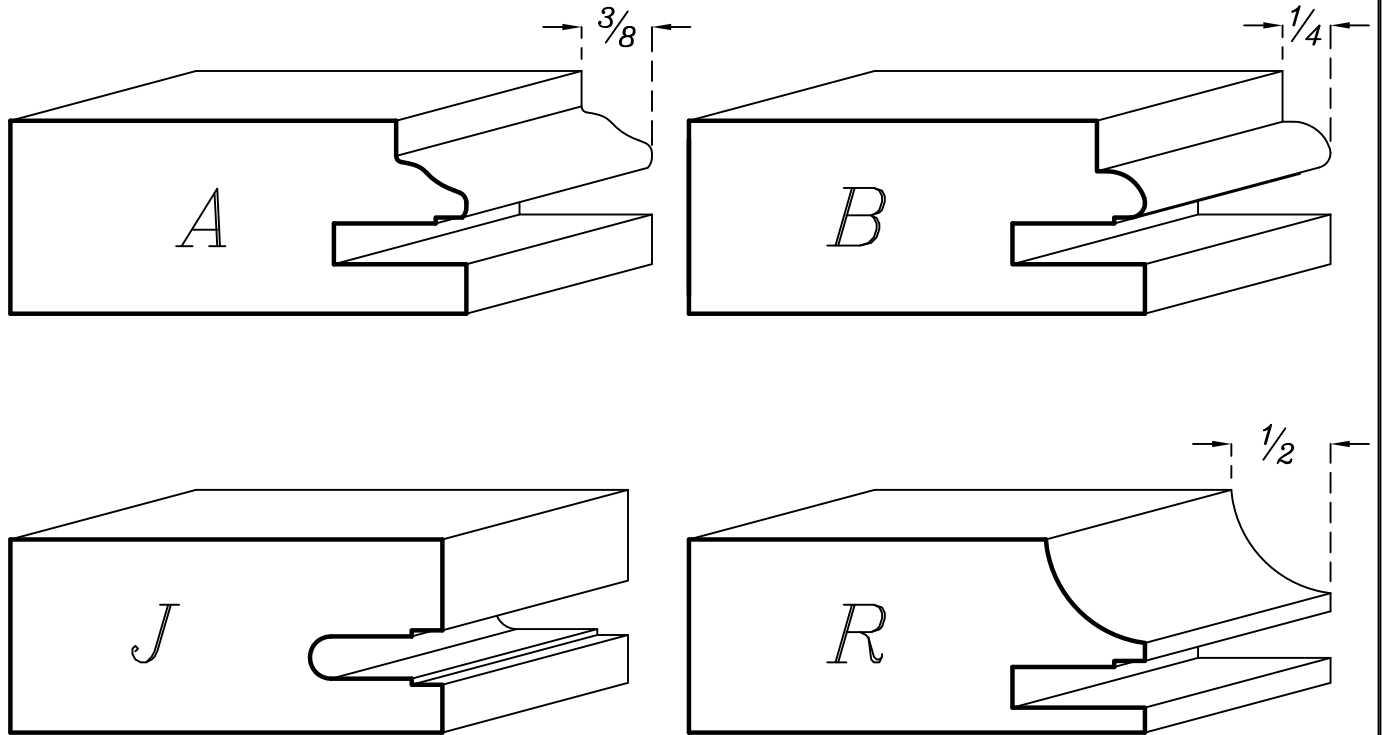

Please take note that the panels available for the Profiles are the same used for the $\frac{3}{4}$ " standard door. On the other hand, the panels are set back from the rails and stiles.

Also, please carefully note that you desire $\frac{7}{8}$ " or 1" doors on your work order.

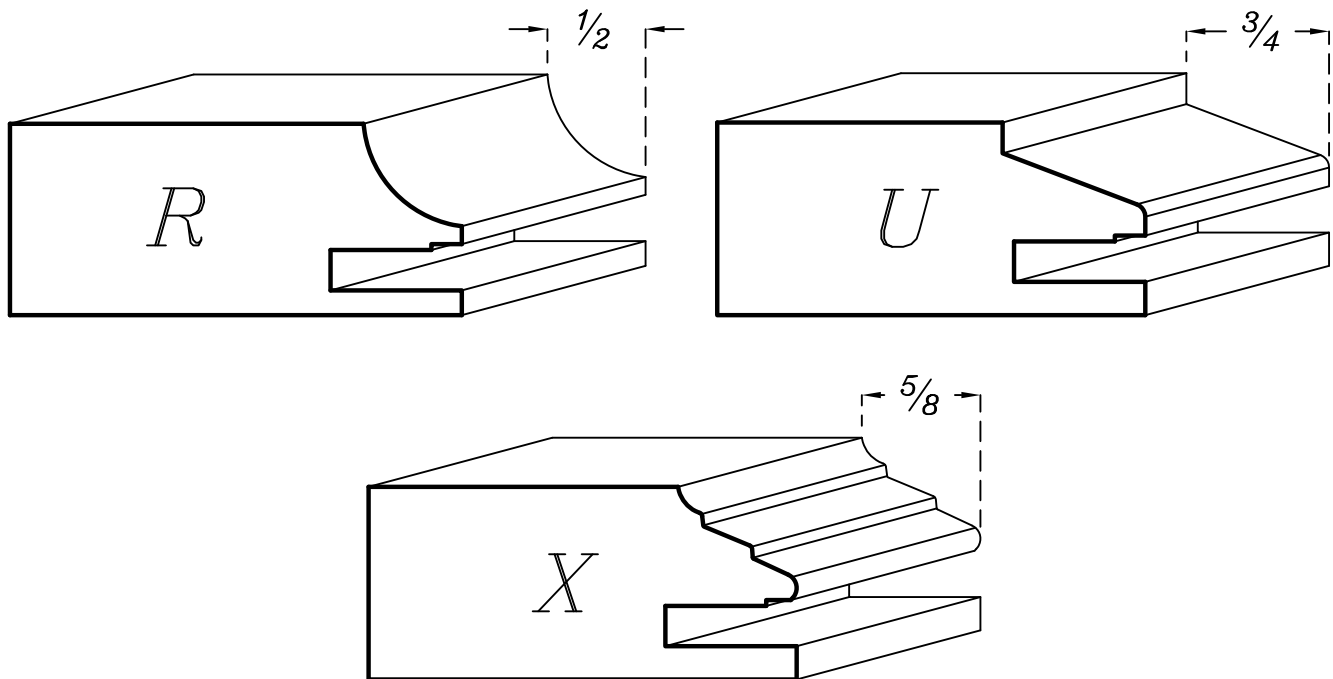

The panels available for these framing beads are those dedicated to the profile R,U and X in the Profiles section of the panels.

The center panels of the $\frac{3}{4}$ " thick standard doors can be used for these Profiles. On the other hand, the panels are set back from the rails and stiles.

P=SOLID PANEL / M=MDF PANEL

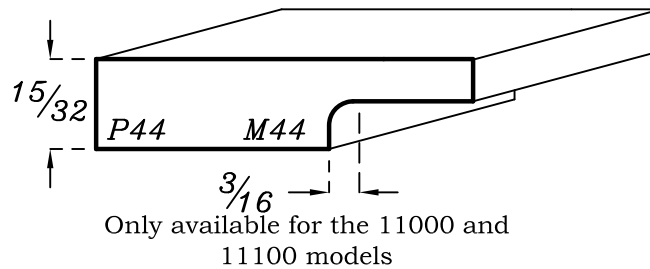
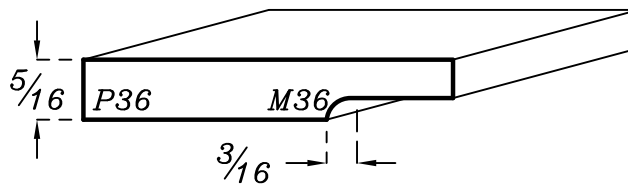
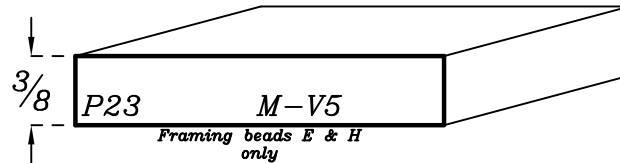
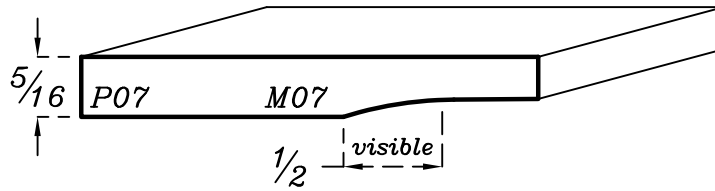

P=SOLID PANEL / M=MDF PANEL

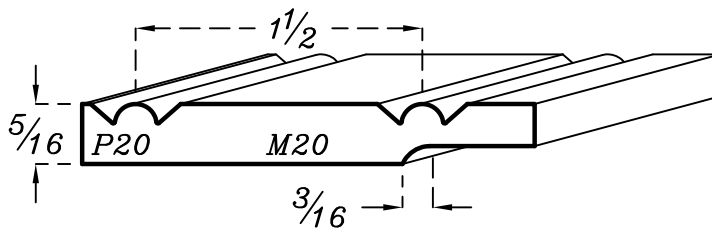
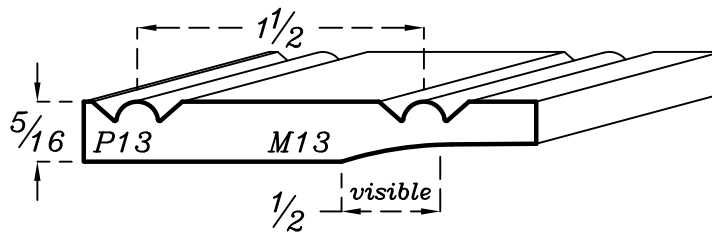
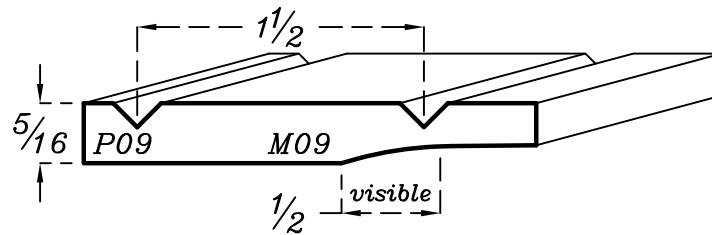
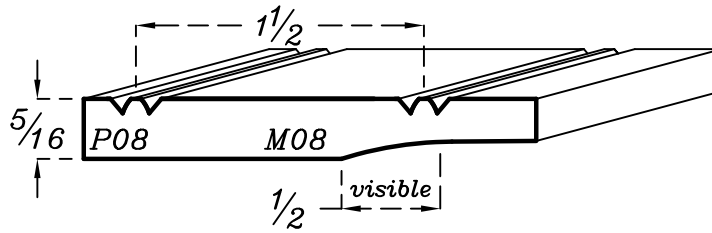

Profiles

Reverse panels with grooves

door $\frac{3}{4}$ " thick standard and mitered

P=SOLID PANEL / M=MDF PANEL

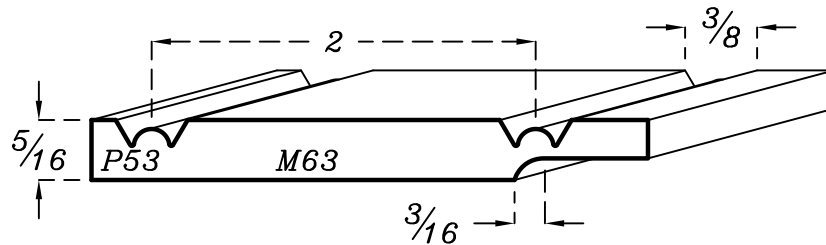
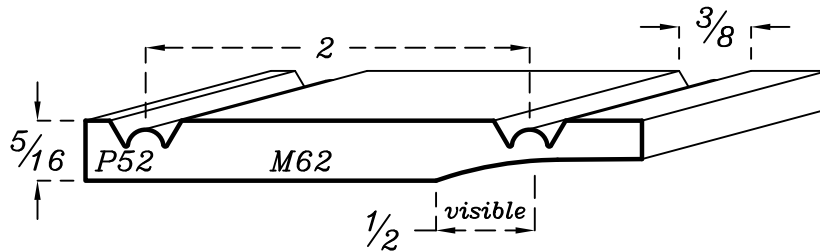
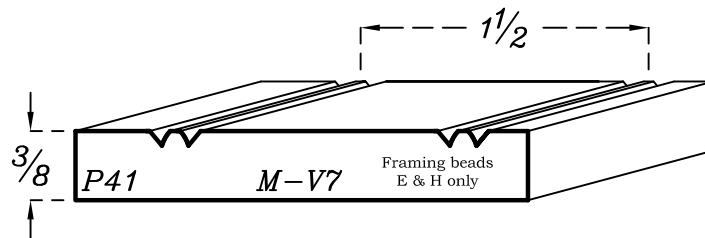
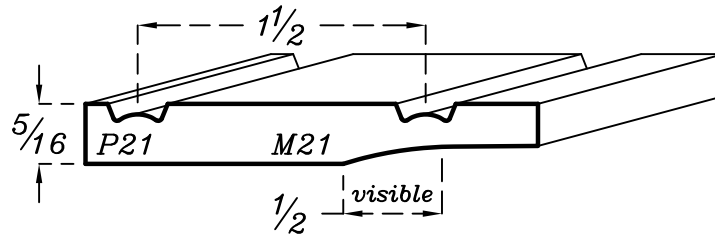

P=SOLID PANEL / M=MDF PANEL

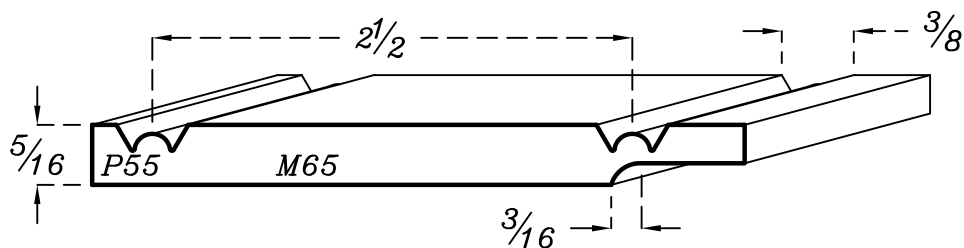

Profiles

Center panel profiles

door $\frac{3}{4}$ " thick standard and mitered

P=SOLID PANEL / M=MDF PANEL

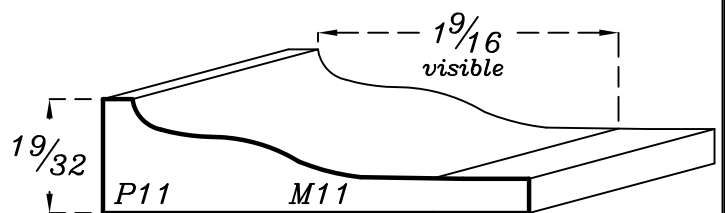
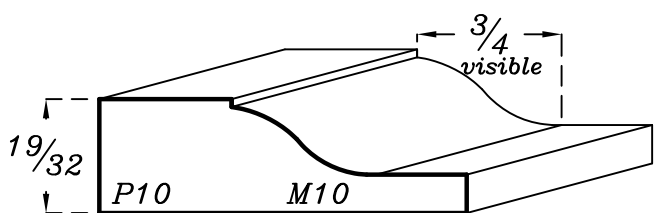
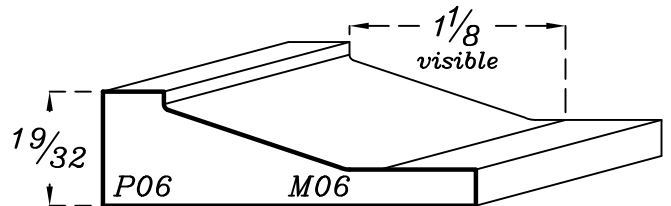
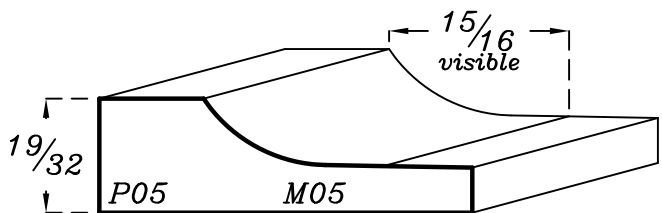
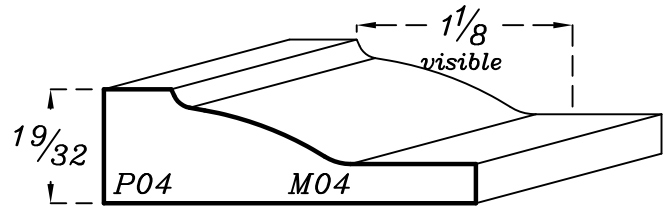
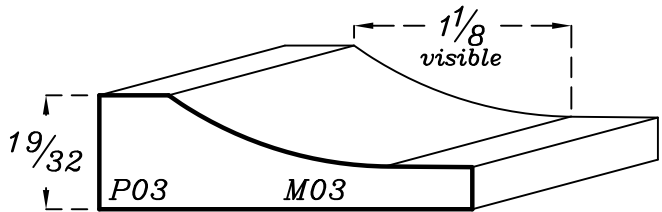
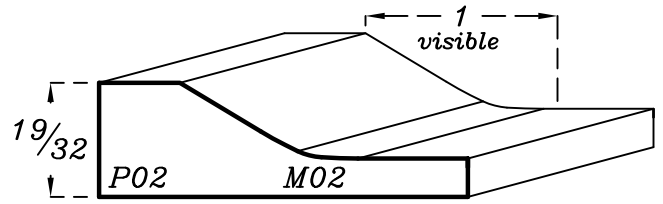
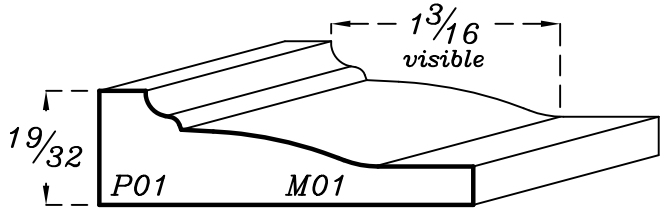

Profiles

Center panel profiles

door $\frac{3}{4}$ " thick standard and mitered

P=SOLID PANEL / M=MDF PANEL

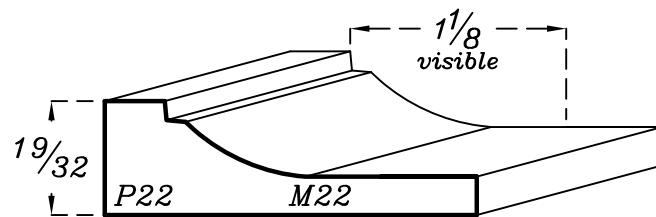
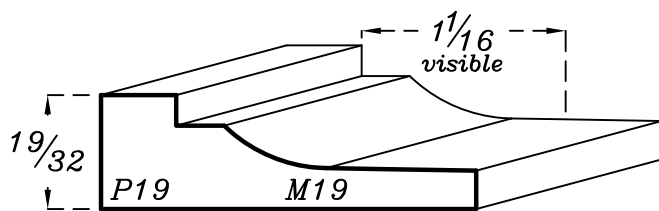
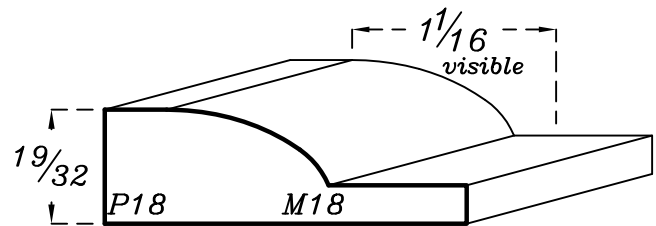
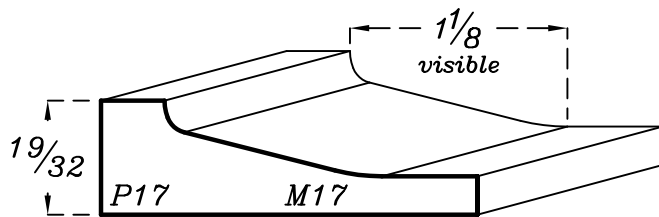
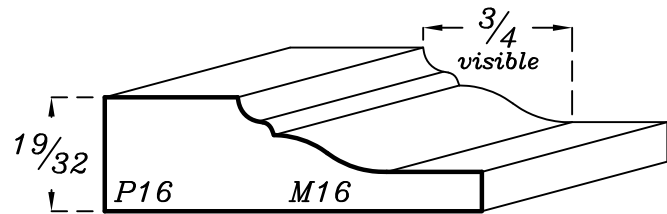
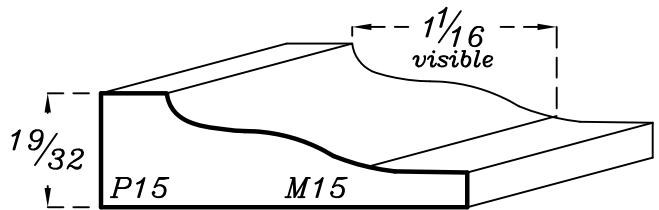
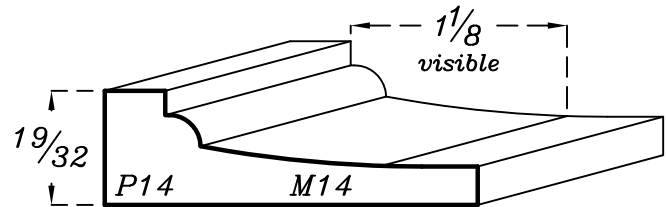
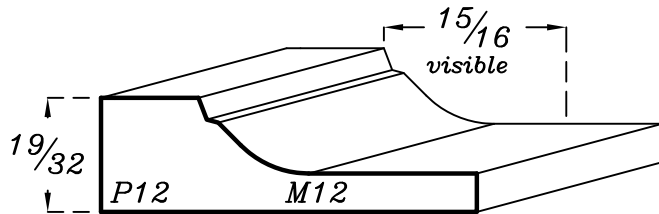

- 1 PROFILES
- 2 TRADITIONAL 90
- 3 DISTINCTIVE 90
- 4 CATHEDRAL 90
- 5 APPLIED MOULDINGS
- 6 PRESTIGE 45
- 7 WANSCOTS
- 8 SPECIALTY PRODUCTS
- 9 MOULDINGS
- 10 PROMOTIONAL ITEMS
- 11 POLICY

Profiles

Center panel profiles

door $\frac{3}{4}$ " thick standard and mitered

P=SOLID PANEL / M=MDF PANEL

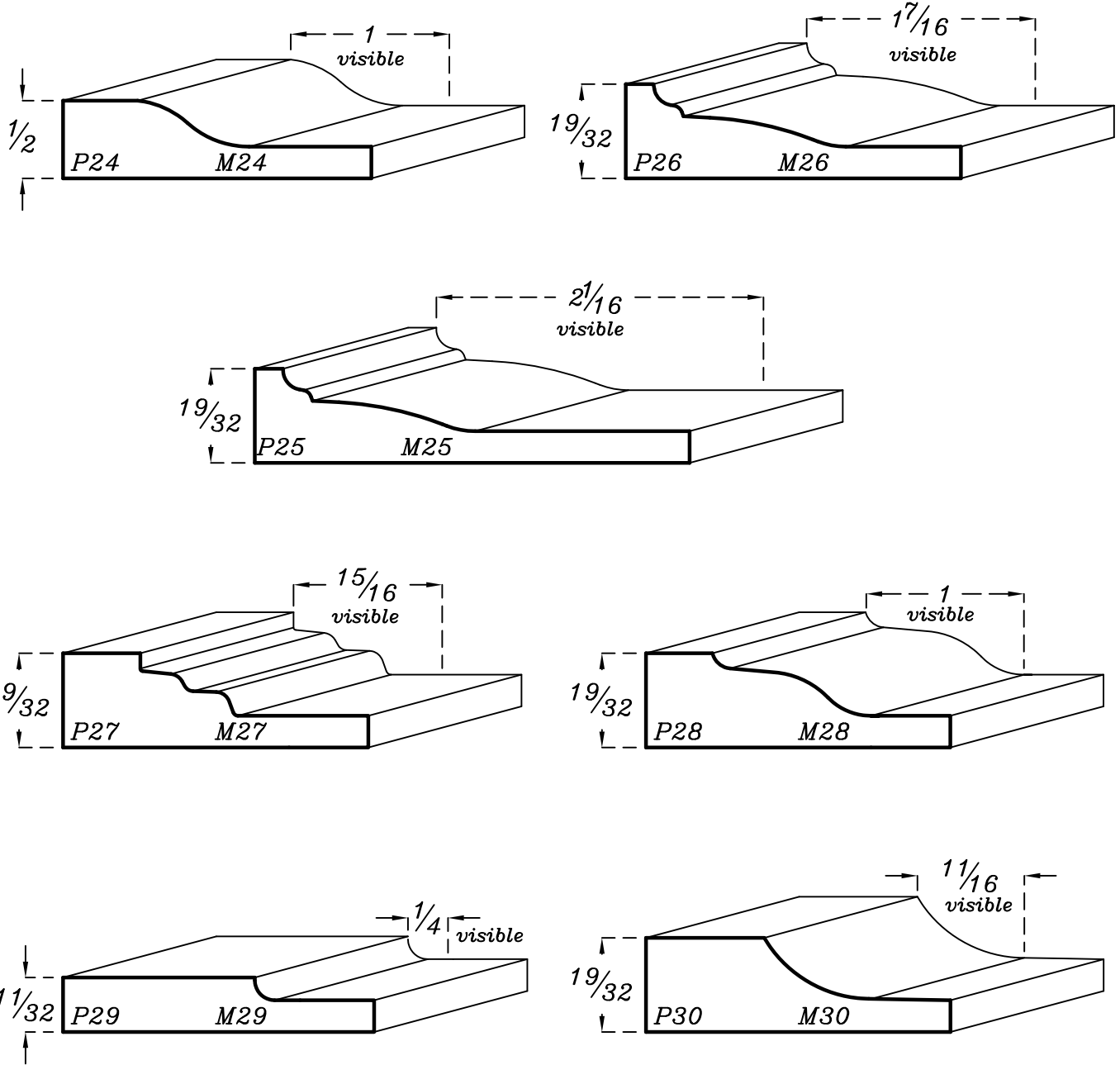

door $\frac{3}{4}$ " thick standard and mitered

P=SOLID PANEL / M=MDF PANEL

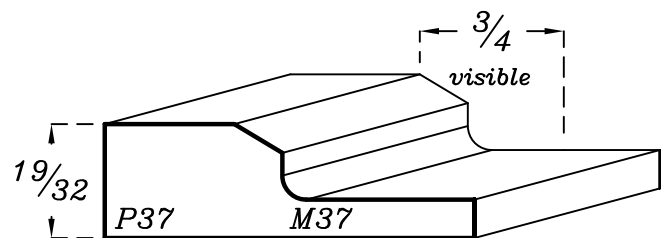
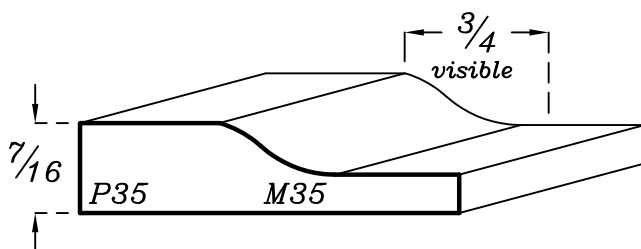
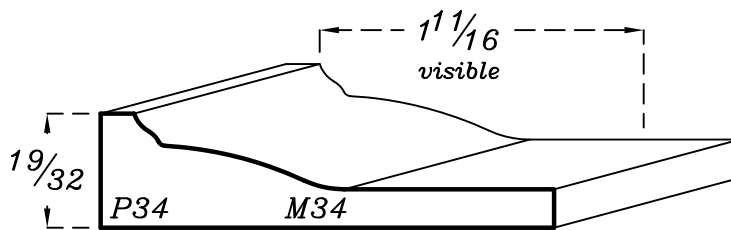
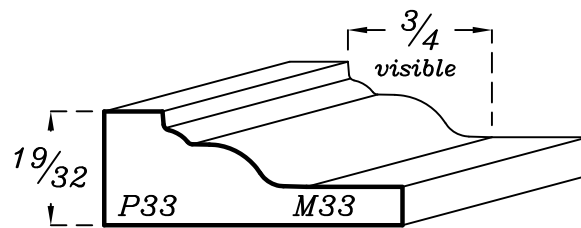
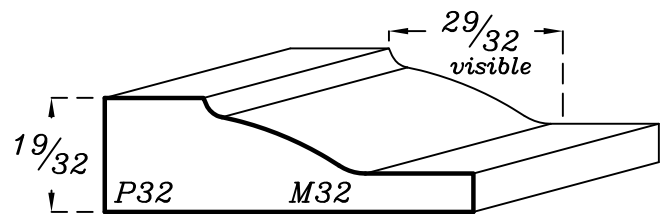
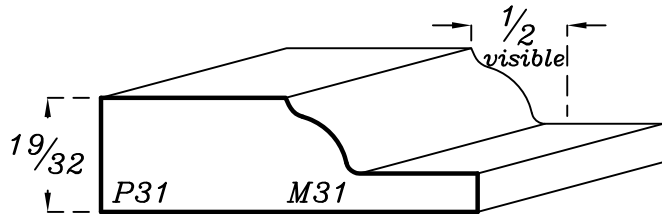

door $\frac{3}{4}$ " thick standard and mitered

P=SOLID PANEL / M=MDF PANEL

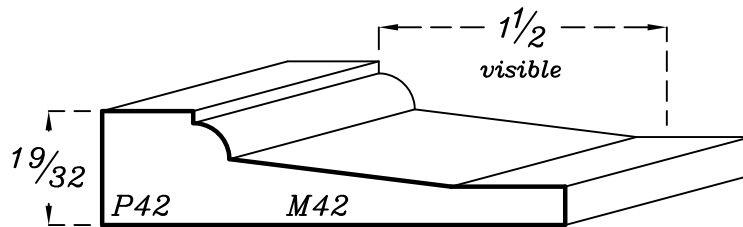
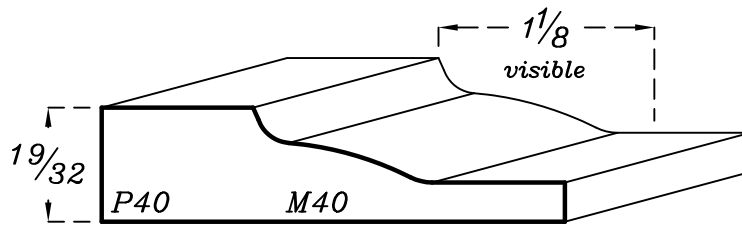
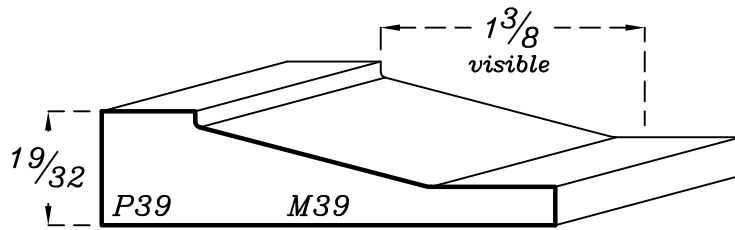
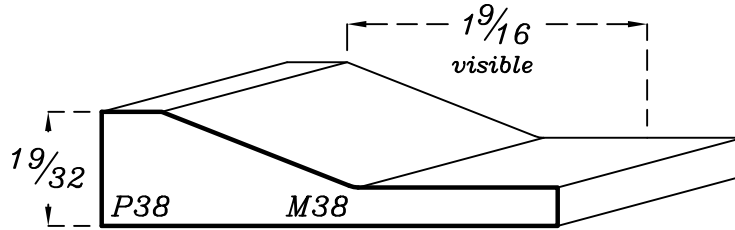

Profiles

Center panel profiles

door $\frac{3}{4}$ " thick standard and mitered

P=SOLID PANEL / M=MDF PANEL

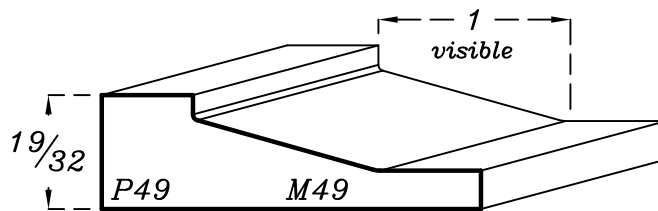
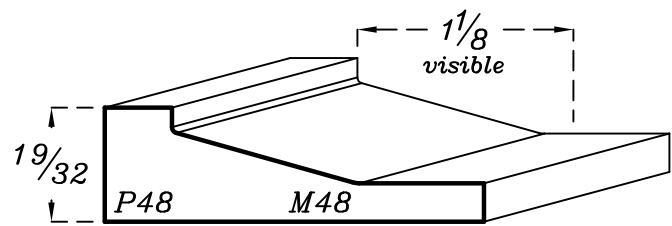
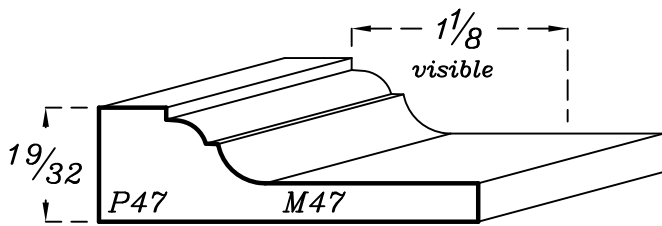
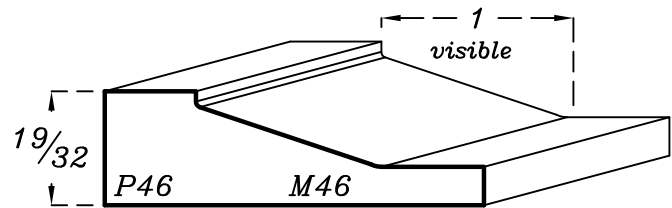
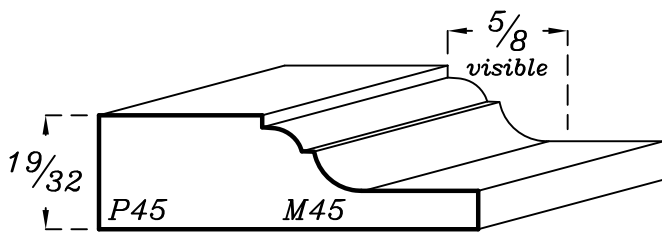
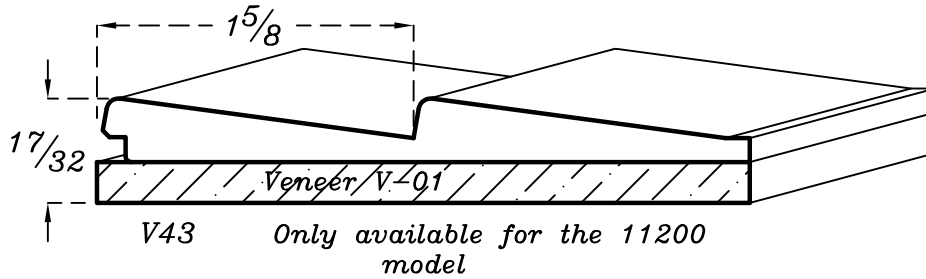

- 1 PROFILES
- 2 TRADITIONAL 90
- 3 DISTINCTIVE 90
- 4 CATHEDRAL 90
- 5 APPLIED MOULDINGS
- 6 PRESTIGE 45
- 7 WAINSCOTS
- 8 SPECIALTY PRODUCTS
- 9 MOULDINGS
- 10 PROMOTIONAL ITEMS
- 11 POLICY

Profiles

Center panel profiles

door $\frac{3}{4}$ " thick standard and mitered

P=SOLID PANEL / M=MDF PANEL

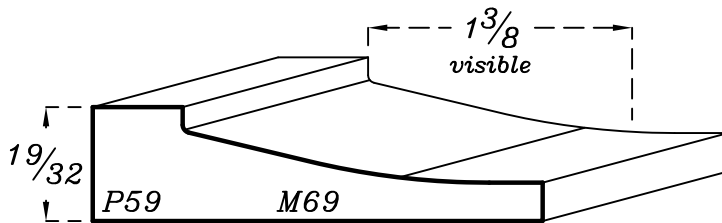
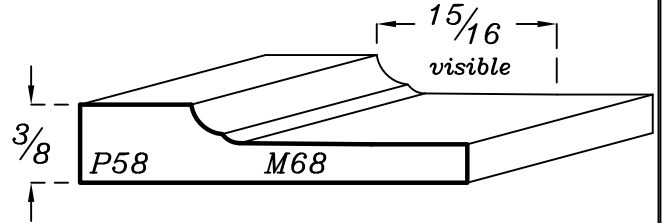
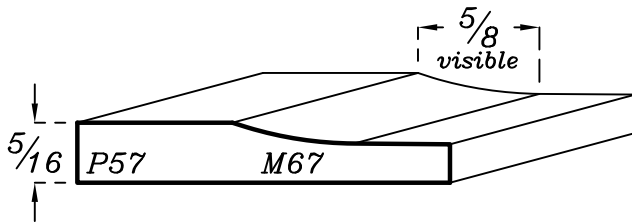
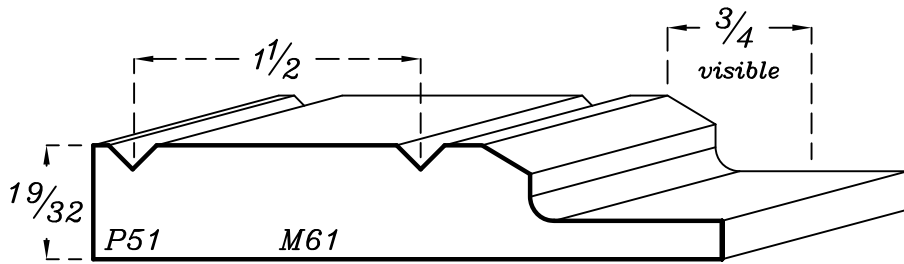
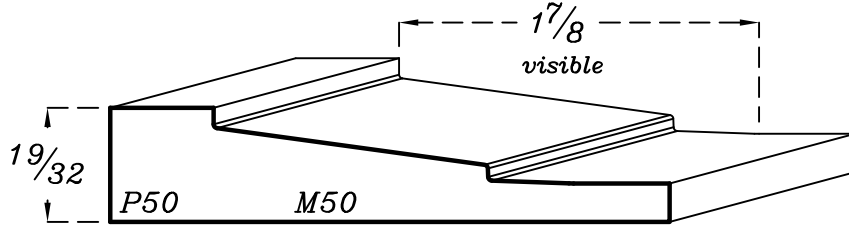

door $\frac{3}{4}$ " thick standard and mitered

P=SOLID PANEL / M=MDF PANEL

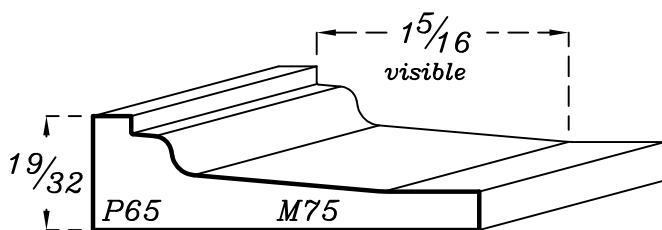
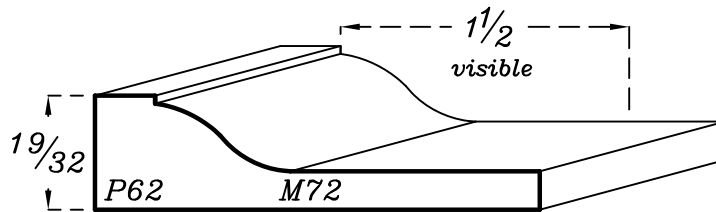
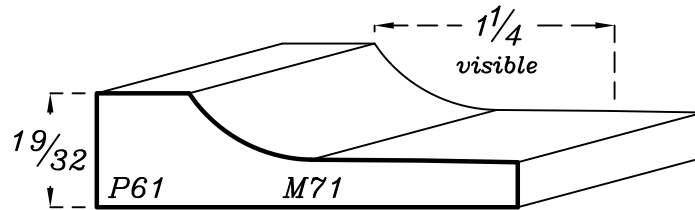
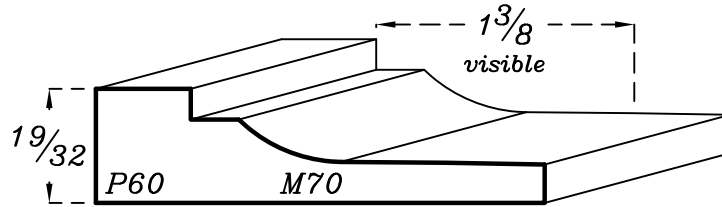

Technical specifications

Standard 3/4" doors

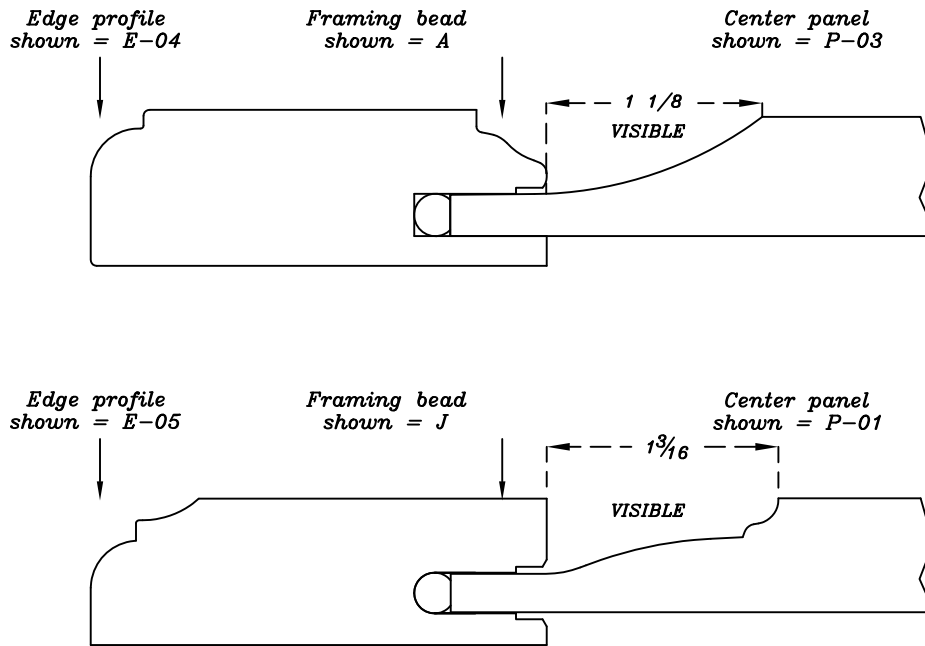

OPTIONS

?	Edge profiles	E-01 to E-58	
?	Framing beads	A/B/F/G/J/K/L/M/N/P/Q R/T/U/V/W/X/Z/2/3/5	
?	Center panels profiles	Solid	P-01 to P-65
		Veneer	V-01 to V-21
		MDF	M-01 to M-75
			M-V1 to M-V3

Technical specifications

Standard 3/4" doors

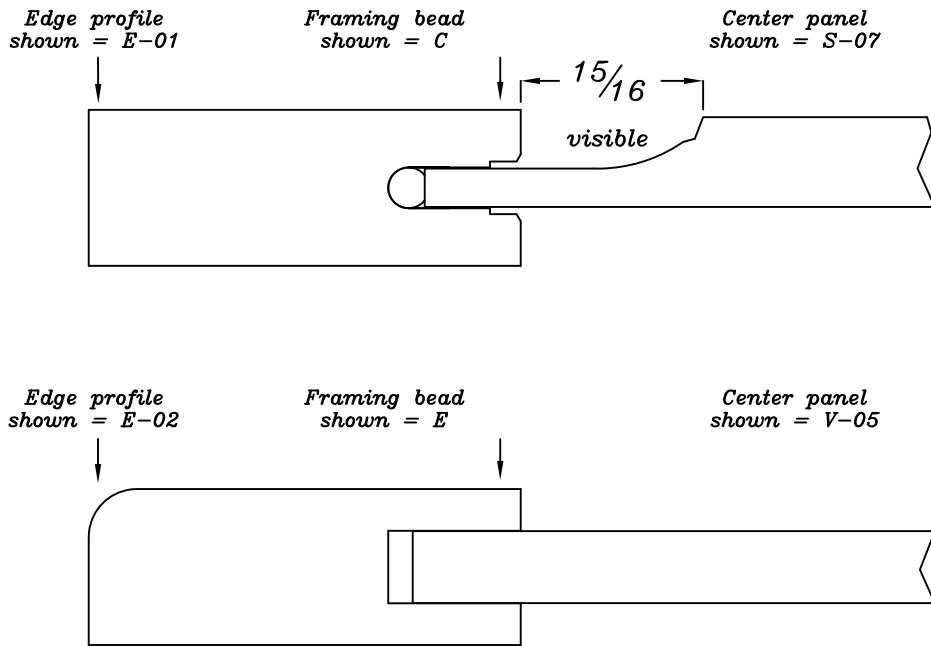

OPTIONS

?	Edge profiles	E-01 to E-58		
?	Framing beads	C/D/O/Y/4/7		E/H/S
?	Center panels profiles	Solid	S-01 to S-17	P-23
		Veneer	V-01 to V-21	V-05 to V-07
		MDF	M-51 to M-517 M-V1 to M-V3	M-V5 to M-V7

Technical specifications

7/8" and 1" doors

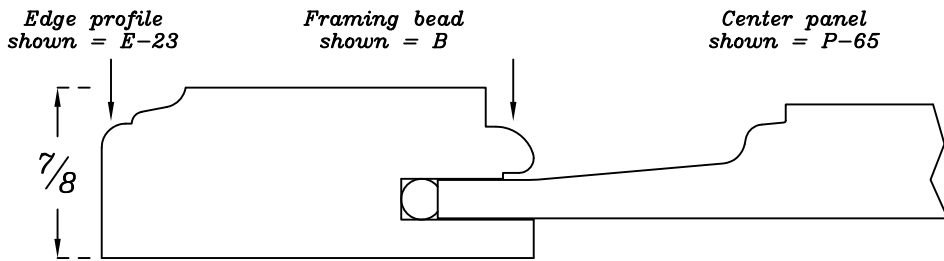
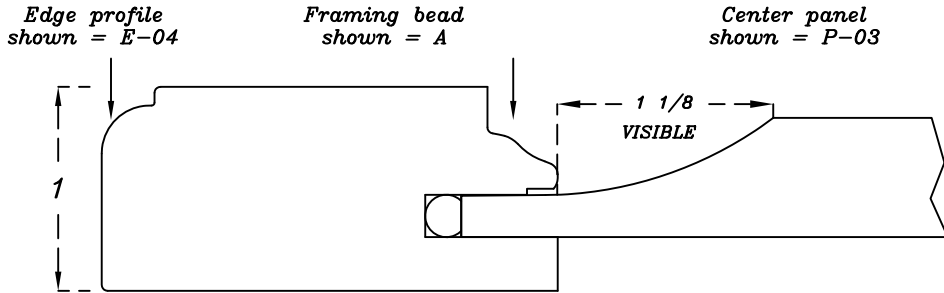

OPTIONS

?	Edge profiles	E-01 to E-58	
?	Framing beads	A/B/J/R	
?	Center panels profiles	Solid	P-01 to P-65
		Veneer	V-01 to V-21
		MDF	M-01 to M-75 M-V1 to M-V3

Profiles

Reverse panels

door $\frac{3}{4}$ " thick shaker (Framing beads C, D, O, Y, 4 and 7)

S=SOLID PANEL / M=MDF PANEL

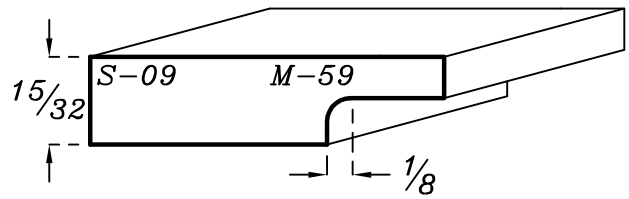
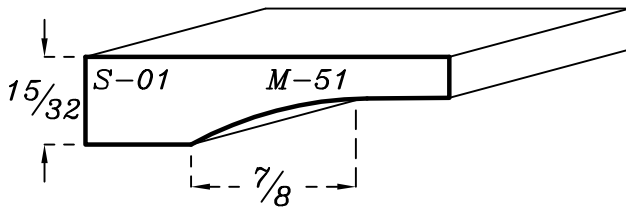

Profiles

Reverse panels with grooves

door $\frac{3}{4}$ " thick shaker (Framing beads C, D, O, Y, 4 and 7)

S=SOLID PANEL / M=MDF PANEL

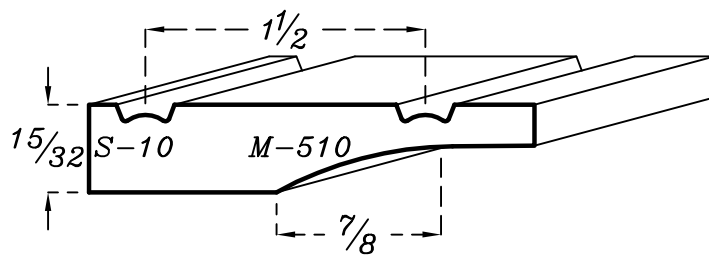
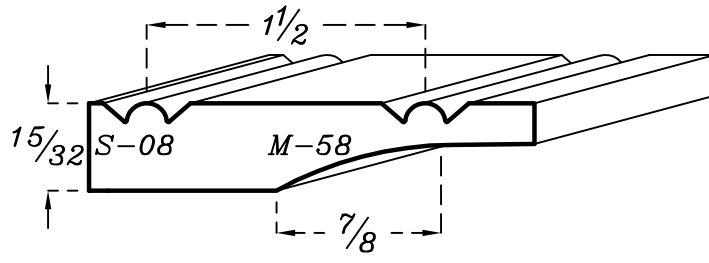
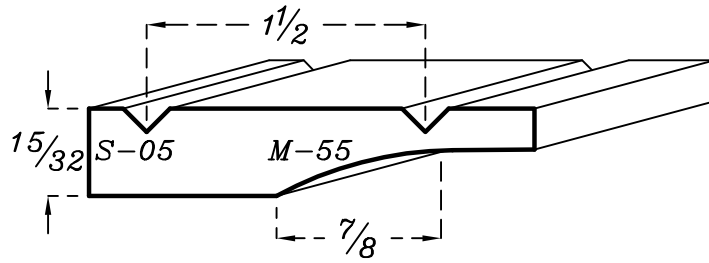
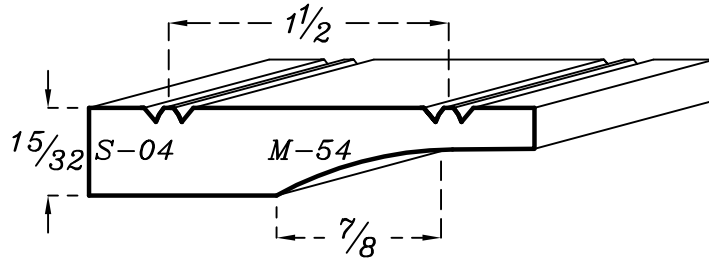

Profiles

Reverse panels with grooves door $\frac{3}{4}$ " thick shaker (Framing beads C, D, O, Y, 4 and 7)

S=SOLID PANEL / M=MDF PANEL

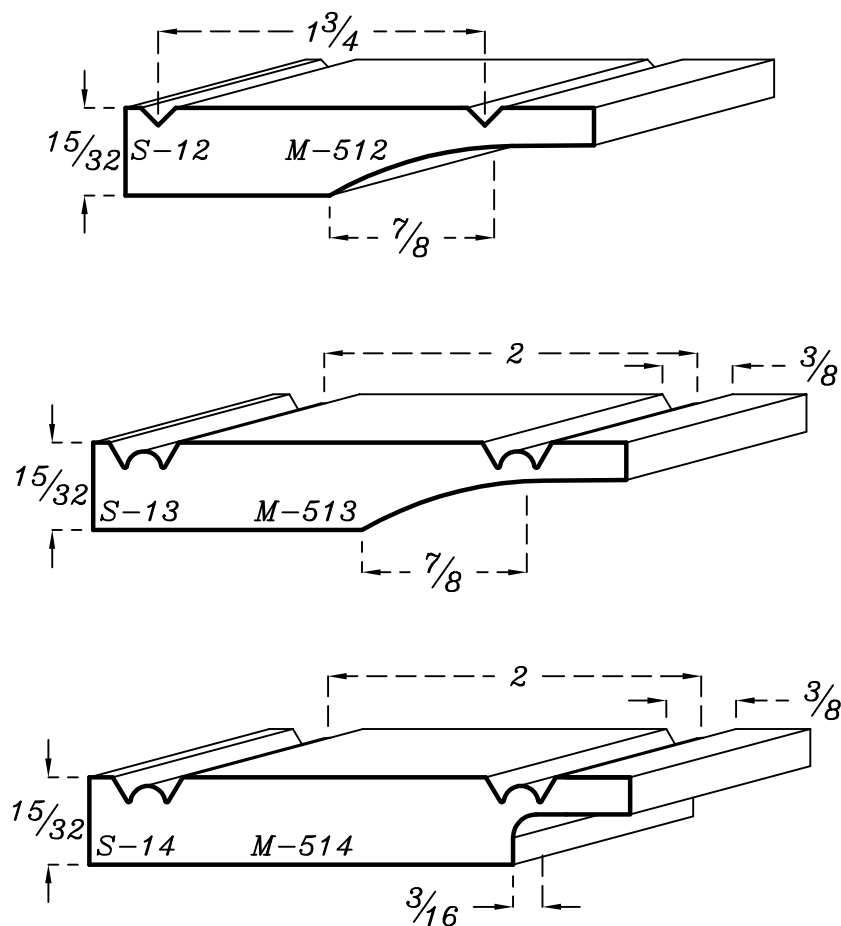

Profiles

Center panel profiles

door $\frac{3}{4}$ " thick shaker (Framing beads C, D, O, Y, 4 and 7)

S=SOLID PANEL / M=MDF PANEL

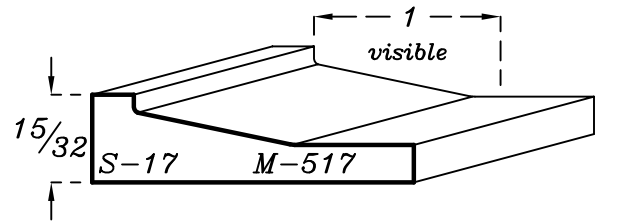
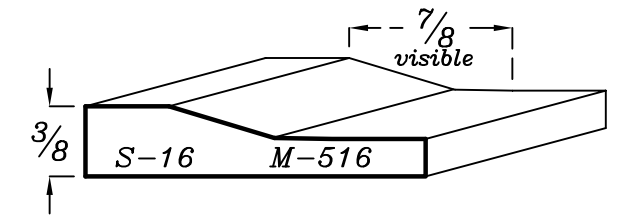
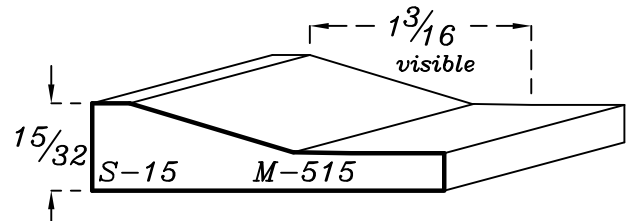
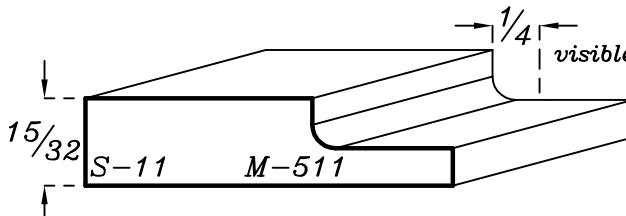
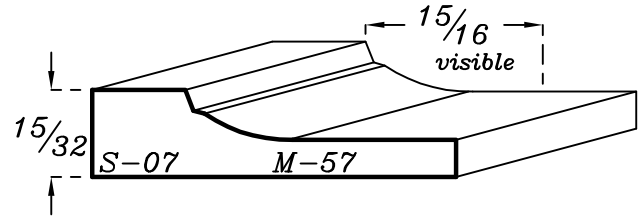
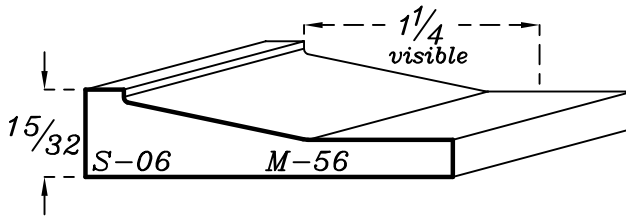
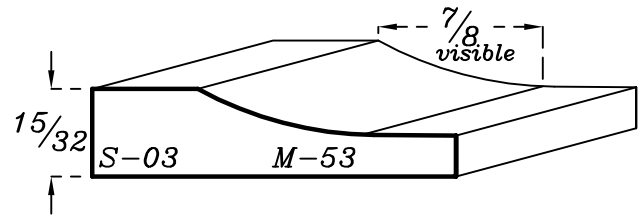
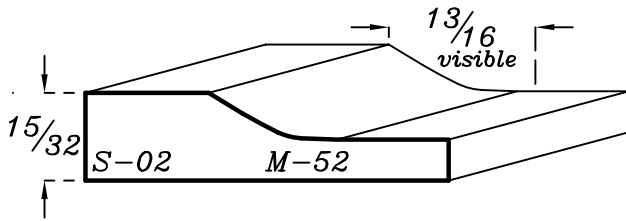

Profiles

Center panel profiles door 1" thick (Framing beads R, U and X)

P=SOLID PANEL / M=MDF PANEL

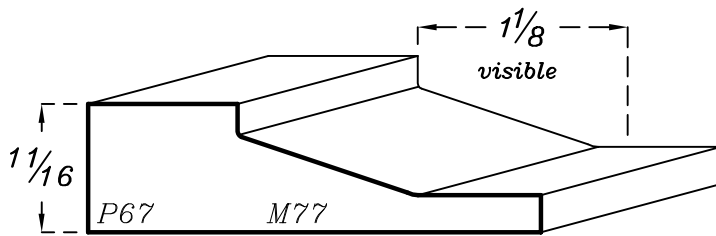
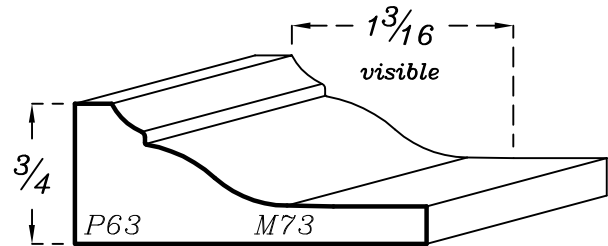
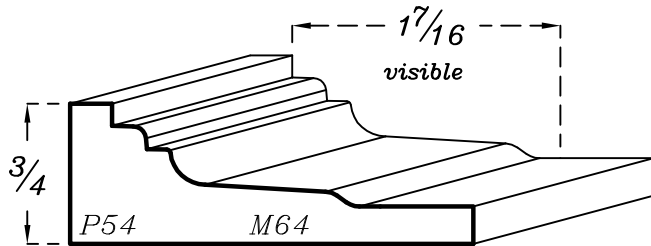

Doors 1" thick for the
 A,B,J Framing beads only

All models except the Framing beads E, H and S

V=VENEER PANELS / M=MDF PANEL

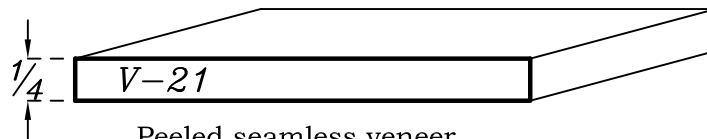
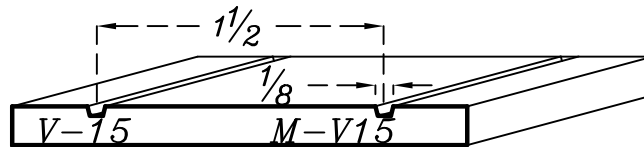
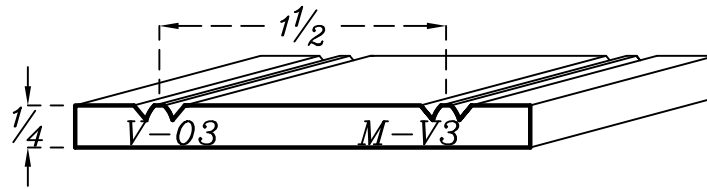
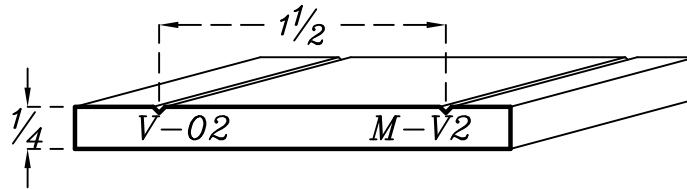
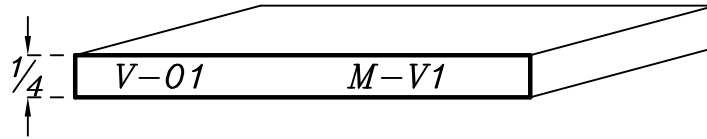

Peeled seamless veneer
on both sides
of the sheet

For the Framing beads E, H and S only

V=VENEER PANELS / M=MDF PANEL

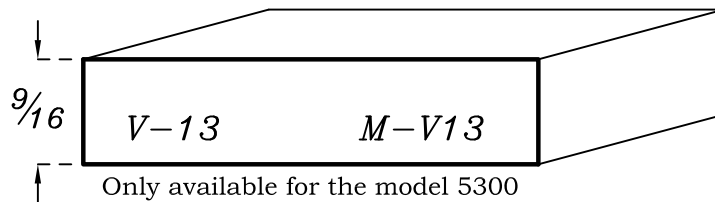
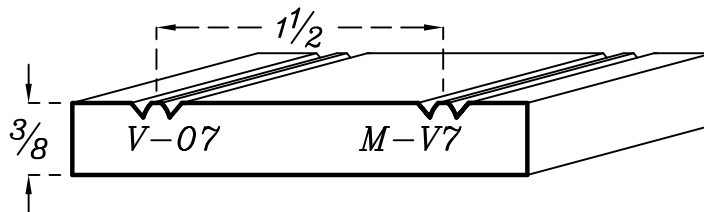
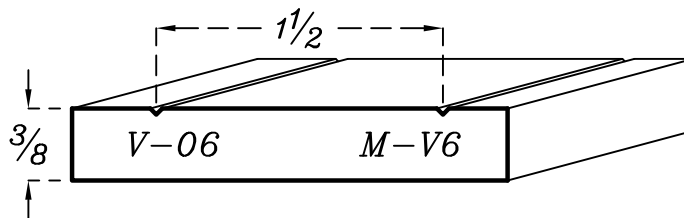
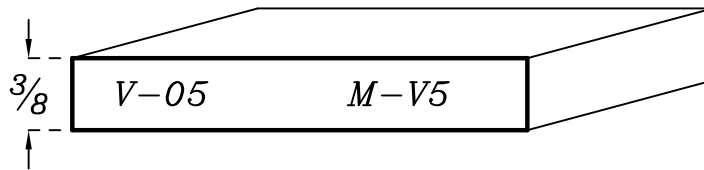

Profiles

Center panel profiles

match profiles with different visible

P=SOLID PANEL / M=MDF PANEL

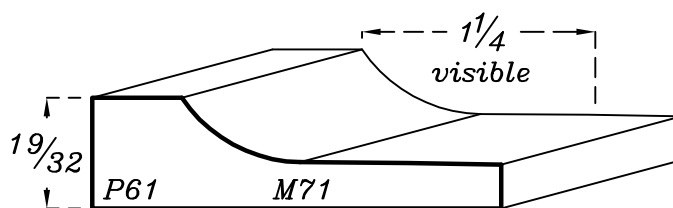
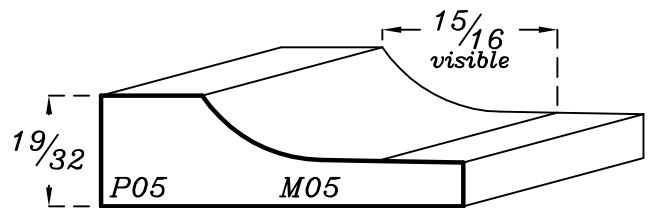
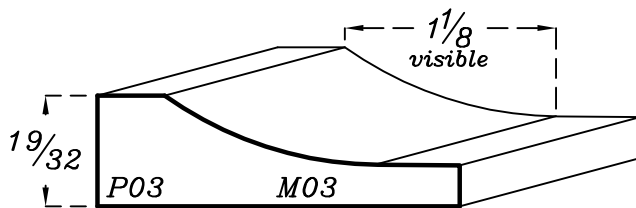
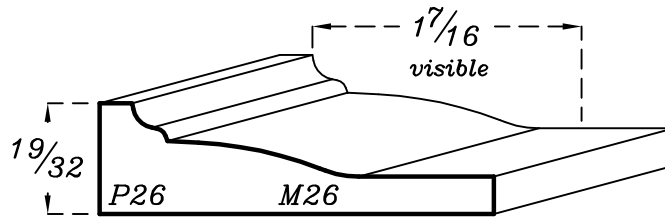
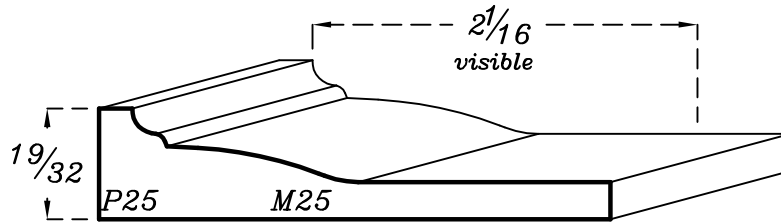
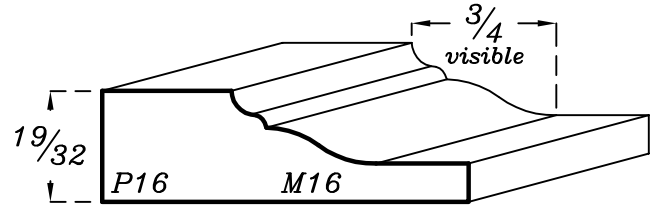
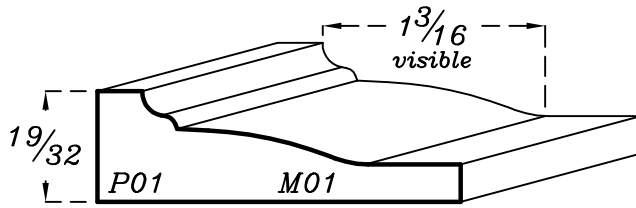

Profiles

Center panel profiles

match profiles with different visible

P=SOLID PANEL / M=MDF PANEL

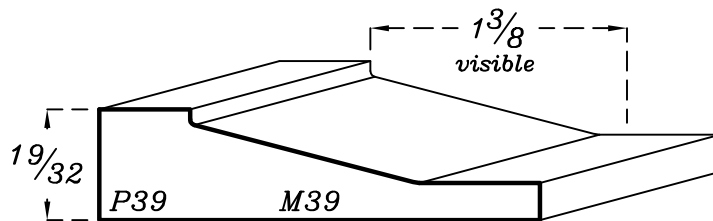
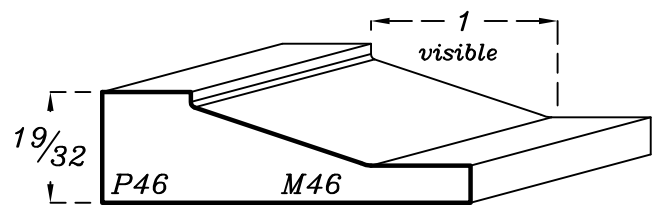
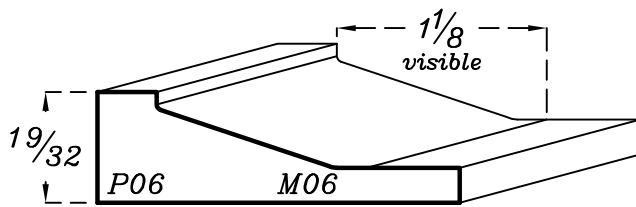
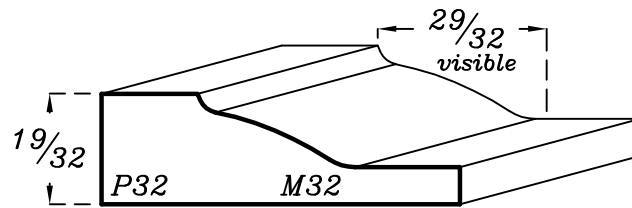
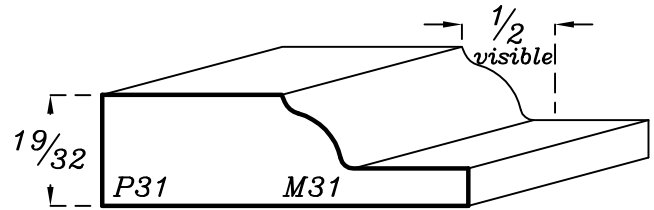
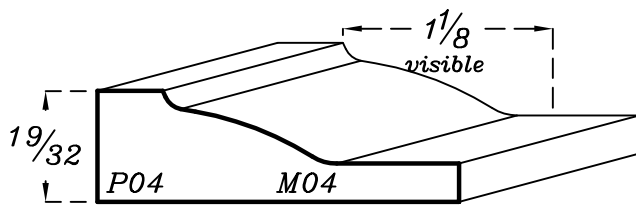

Profiles

Center panel profiles

match profiles with different visible

P=SOLID PANEL / M=MDF PANEL

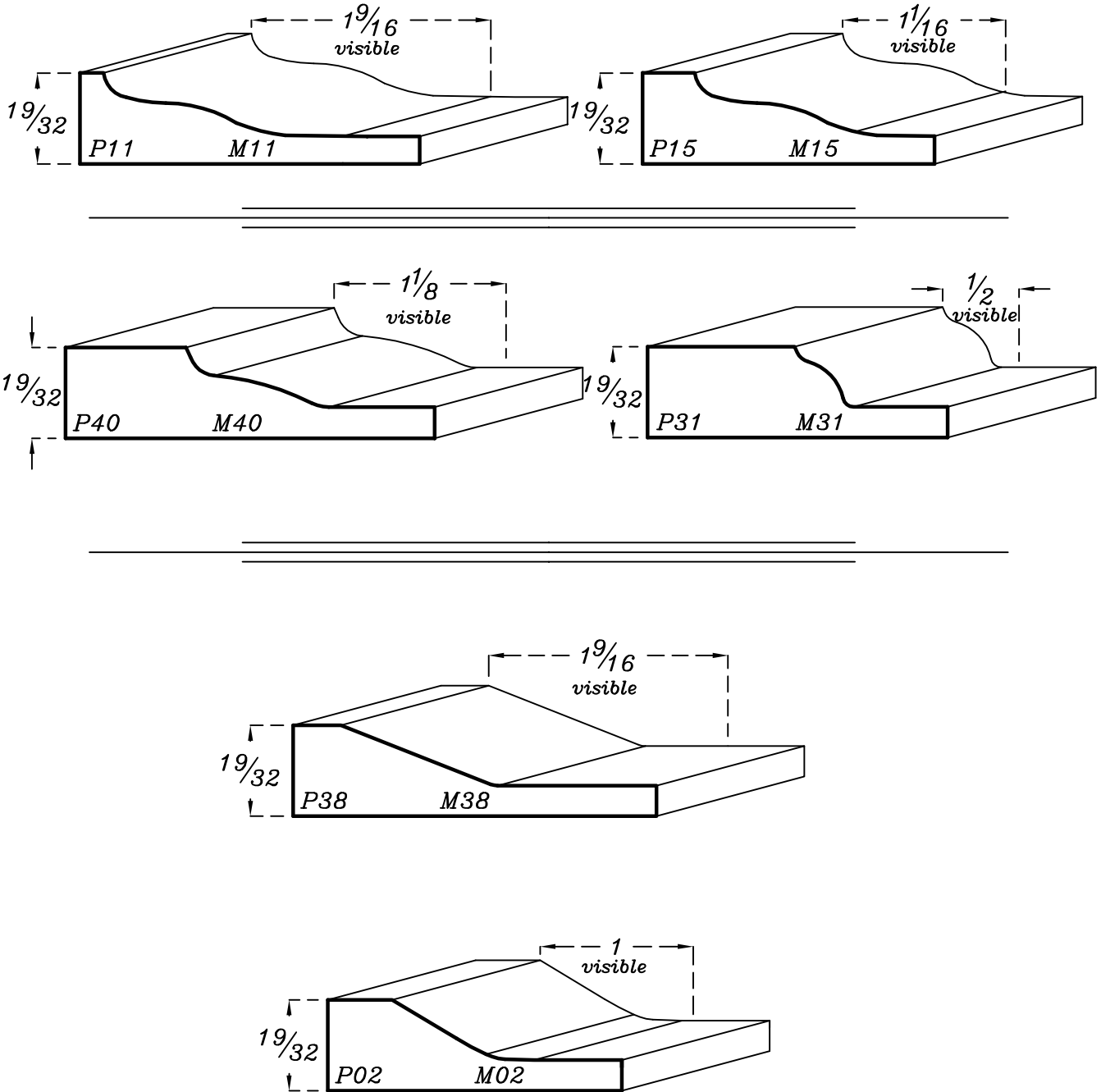

Profiles

Center panel profiles

match profiles with different visible

P=SOLID PANEL / M=MDF PANEL

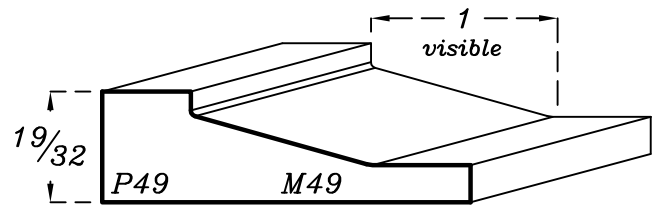
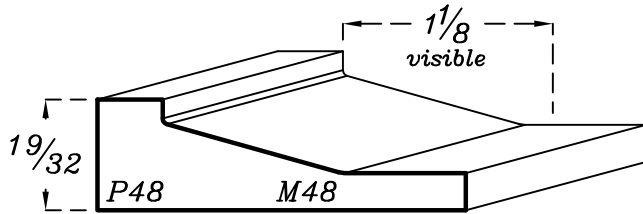
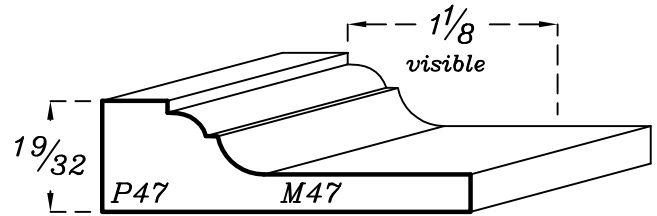
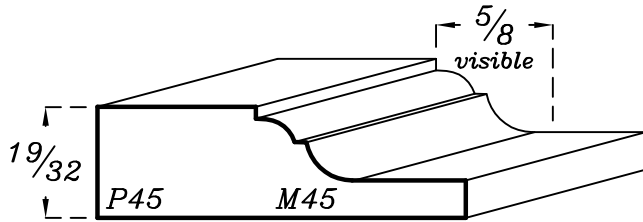

Profiles

Edge profiles

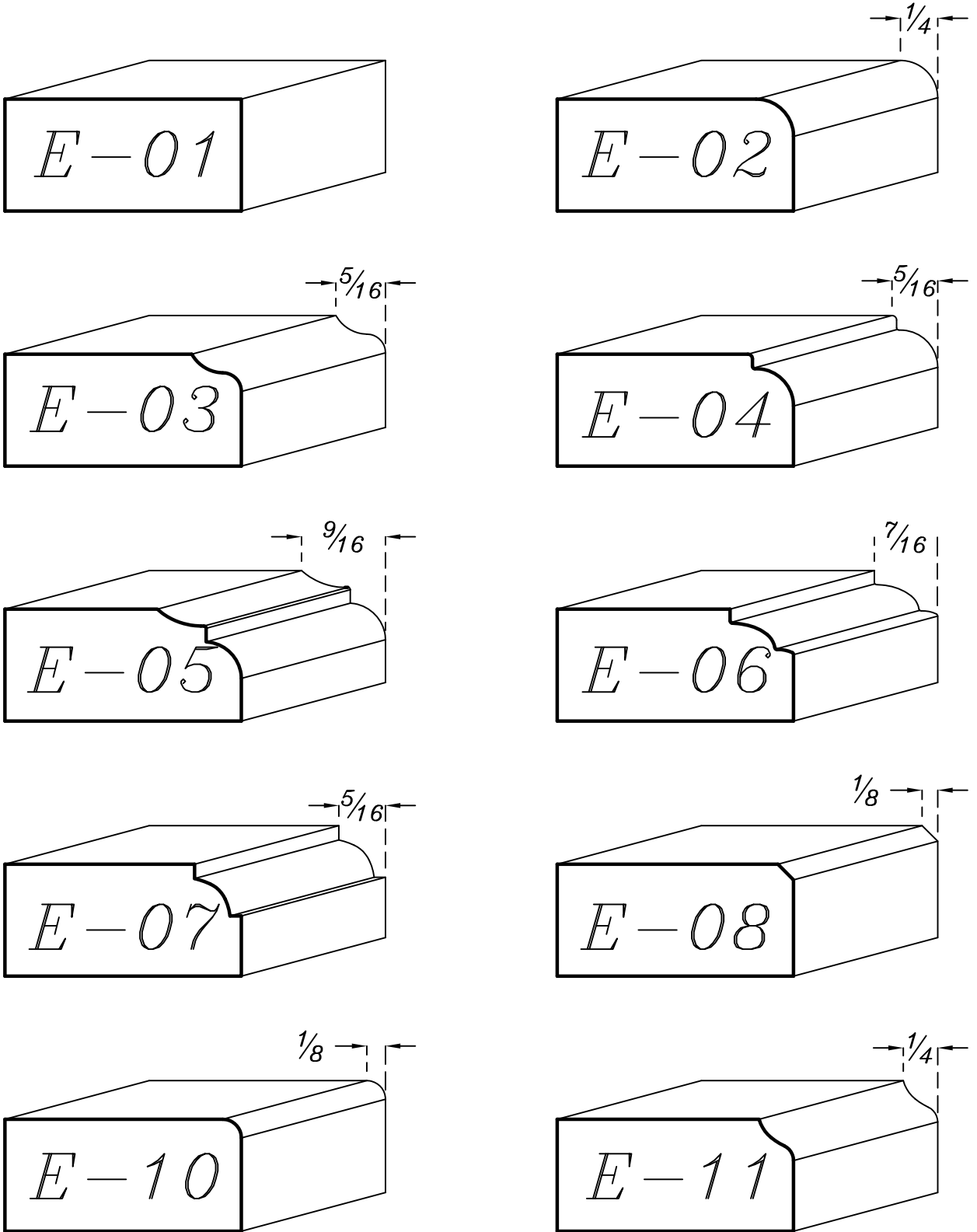

Profiles

Edge profiles

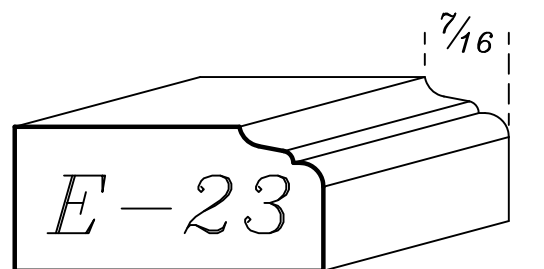
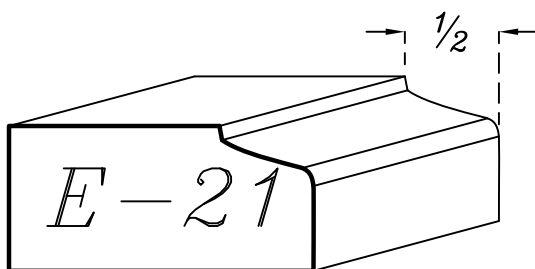
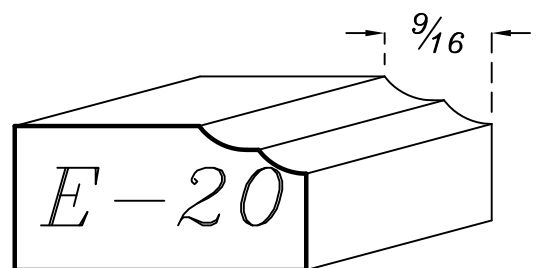
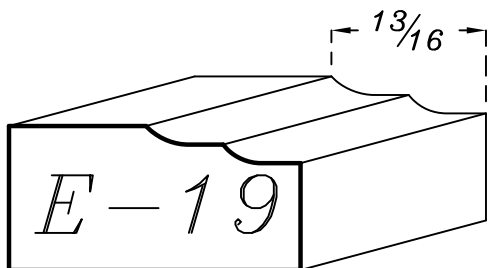
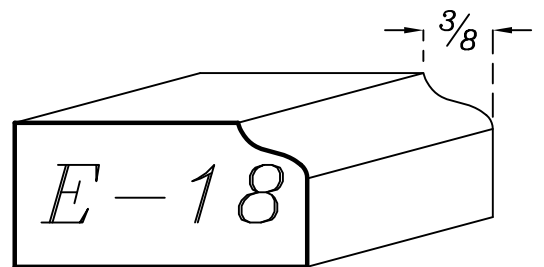
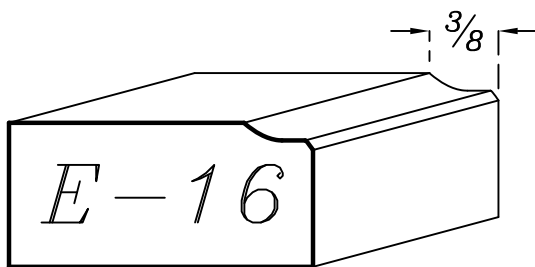
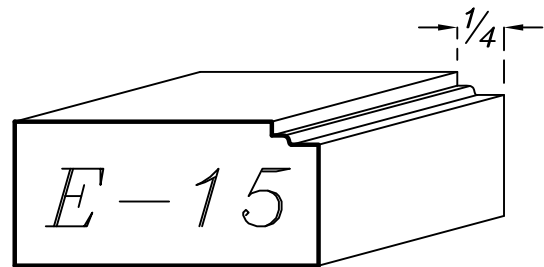
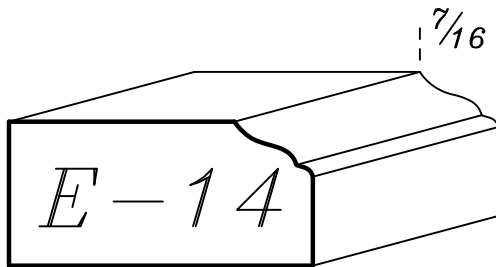
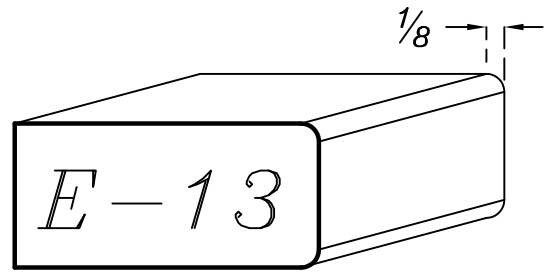
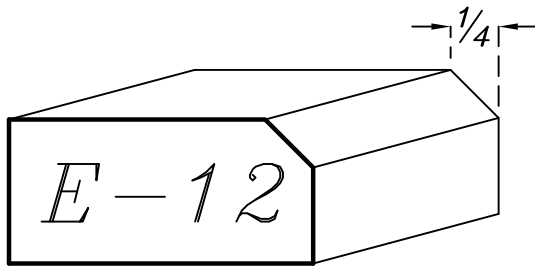

- 1 PROFILES
- 2 TRADITIONAL 90
- 3 DISTINCTIVE 90
- 4 CATHEDRAL 90
- 5 APPLIED MOLDINGS
- 6 PRESTIGE 45
- 7 WANSCOTS
- 8 SPECIALTY PRODUCTS
- 9 MOLDINGS
- 10 PROMOTIONAL ITEMS
- 11 POLICY

Profiles

Edge profiles

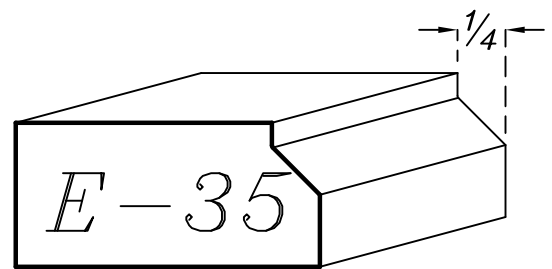
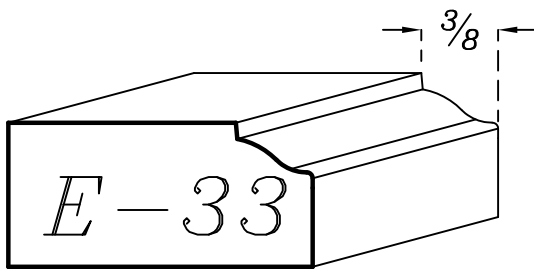
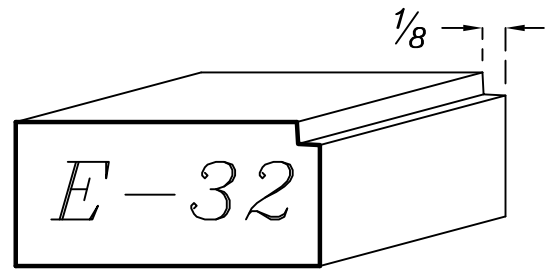
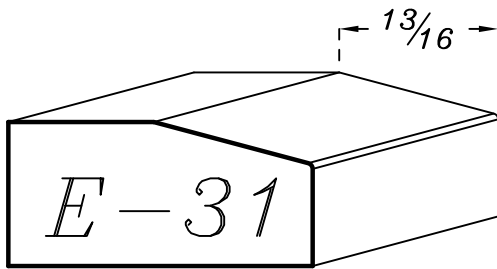
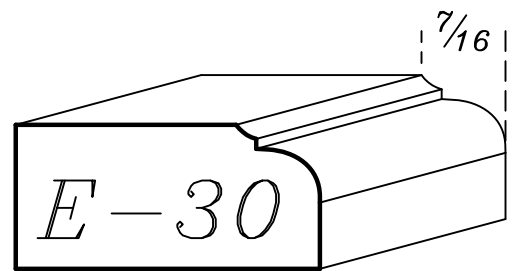
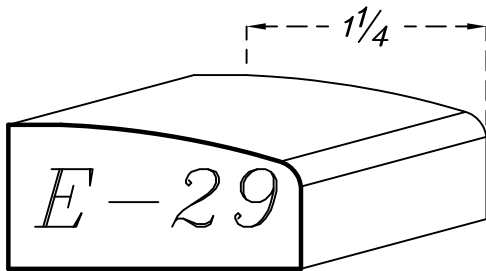
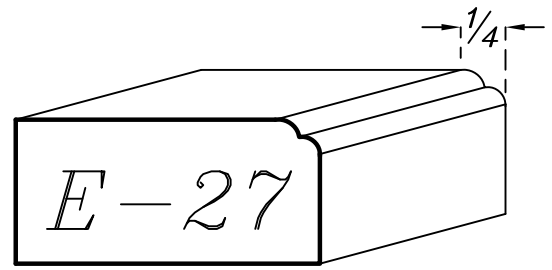
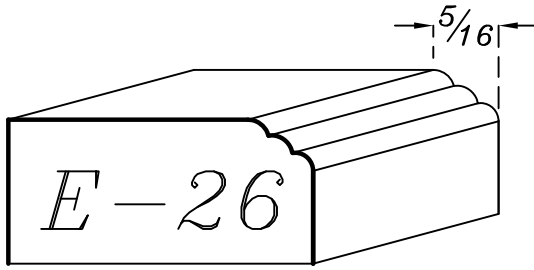
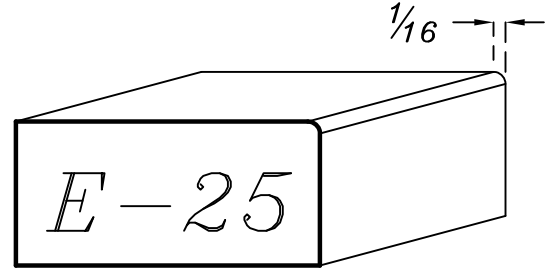
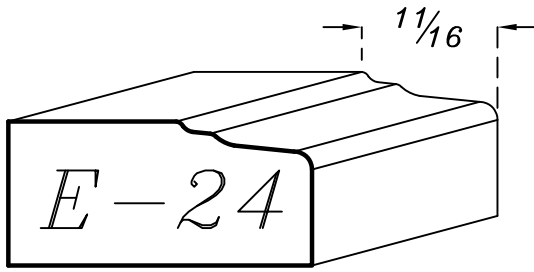

Profiles

Edge profiles

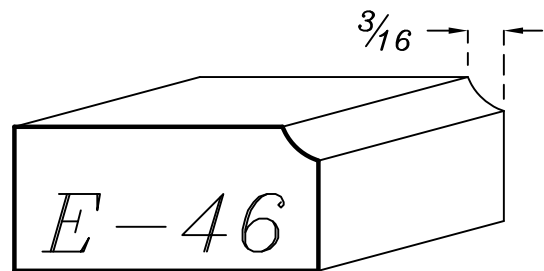
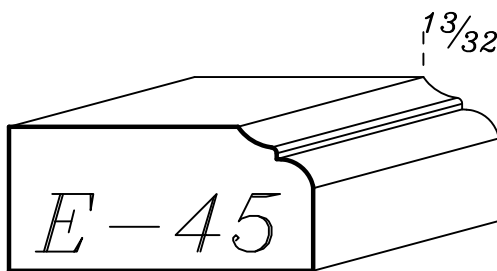
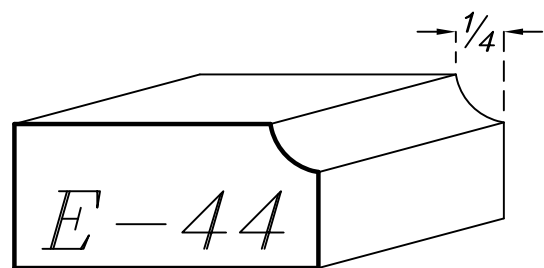
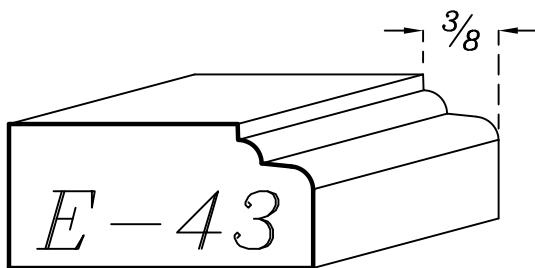
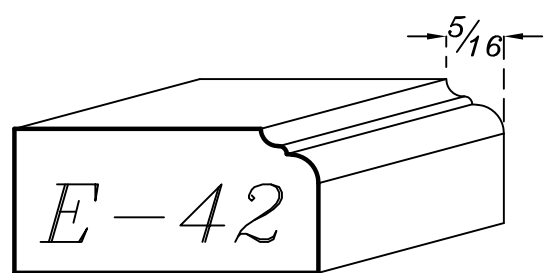
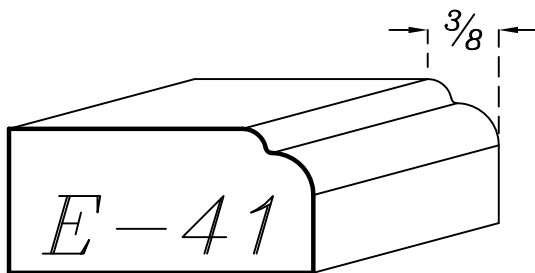
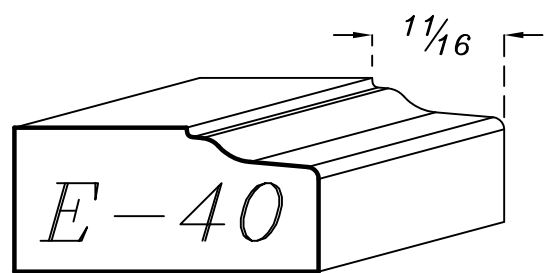
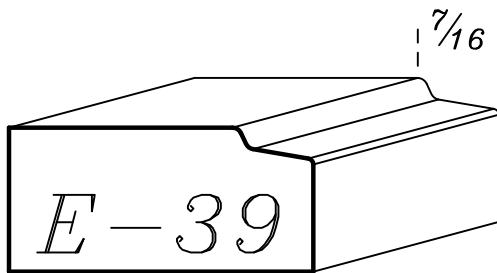
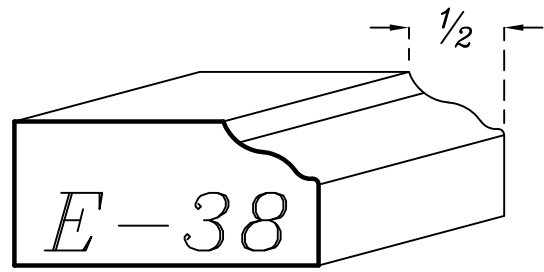
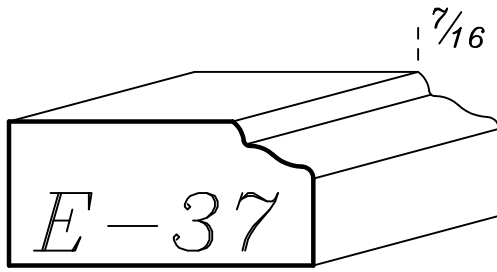

- 1 PROFILES
- 2 TRADITIONAL 90
- 3 DISTINCTIVE 90
- 4 CATHEDRAL 90
- 5 APPLIED MOLDINGS
- 6 PRESTIGE 45
- 7 WANSCOTS
- 8 SPECIALTY PRODUCTS
- 9 MOLDINGS
- 10 PROMOTIONAL ITEMS
- 11 POLICY

Profiles

Edge profiles

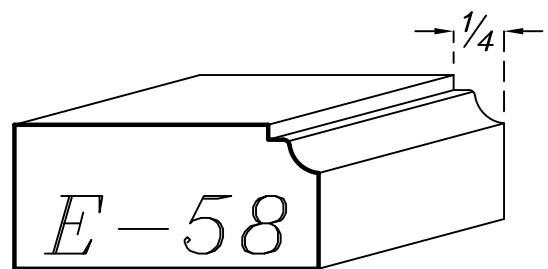
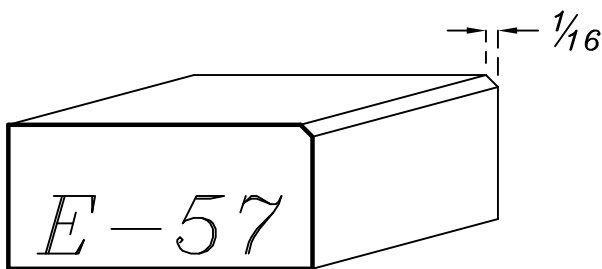
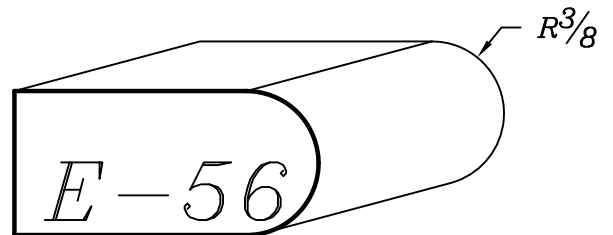
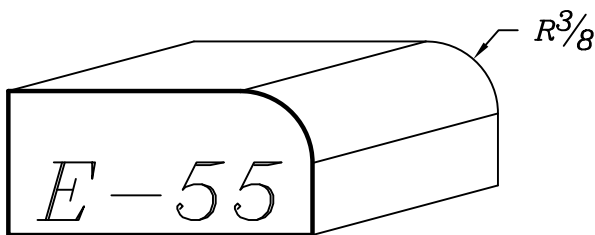
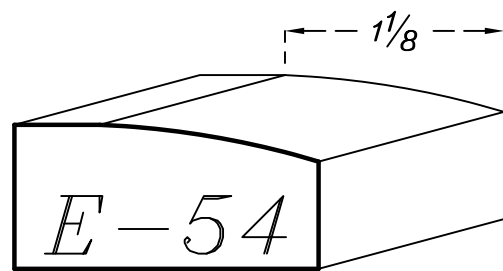
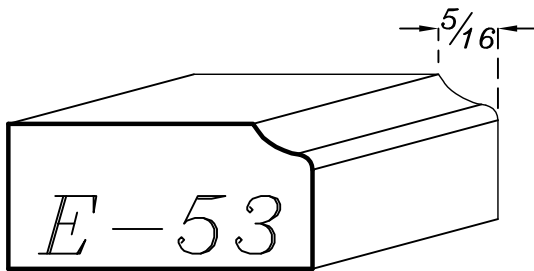
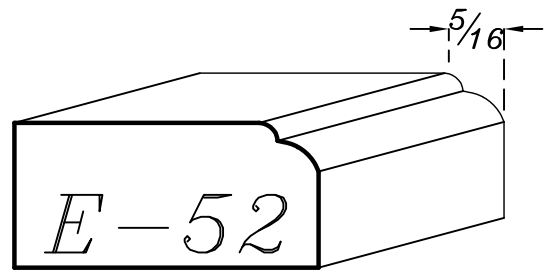
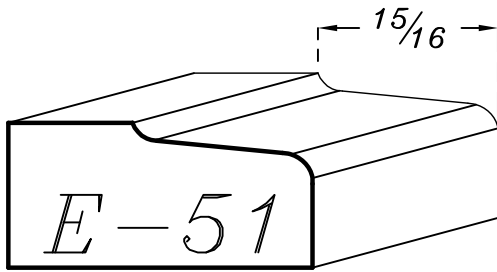
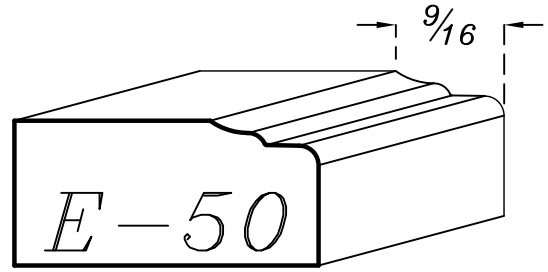
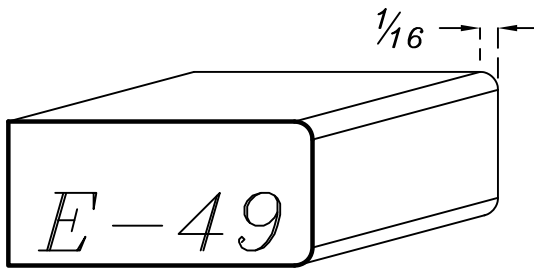

Profiles

Edge profiles Drawer front #51 only

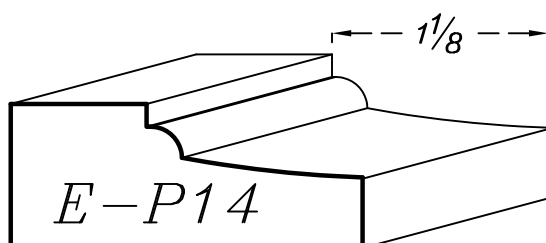
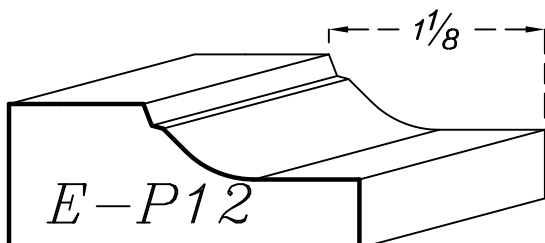
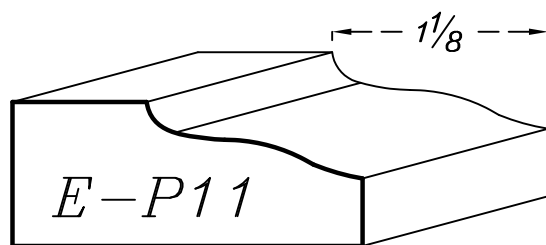
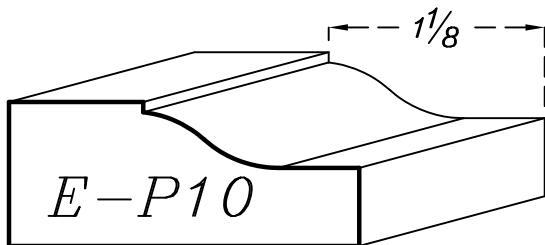
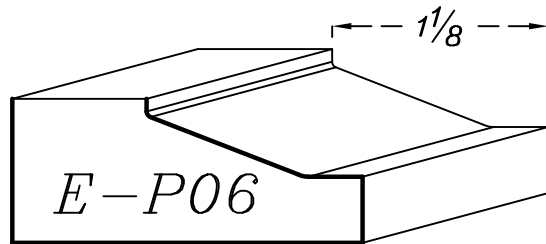
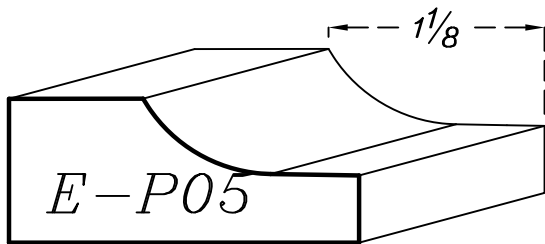
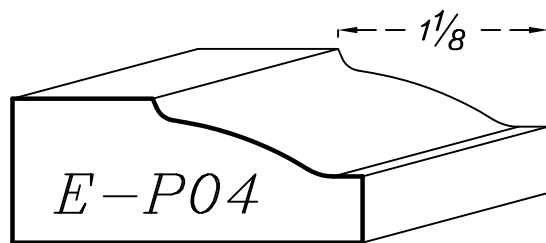
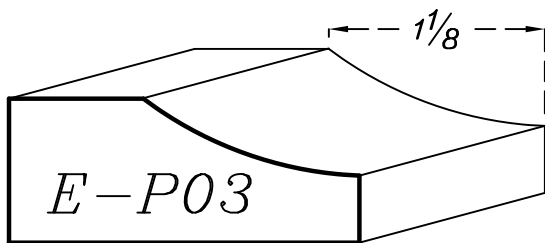
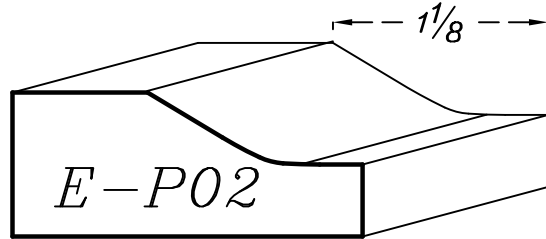
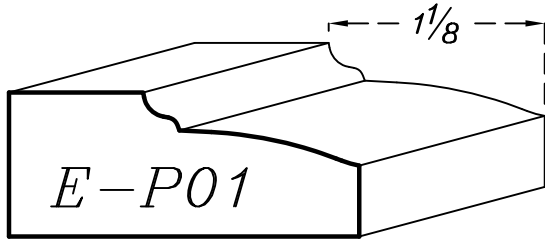

1	PROFILES
2	TRADITIONAL 90
3	DISTINCTIVE 90
4	CATHEDRAL 90
5	APPLIED MOLDINGS
6	PRESTIGE 45
7	WAINSCOTS
8	SPECIALTY PRODUCTS
9	MOLDINGS
10	PROMOTIONAL ITEMS
11	POLICY

Profiles

Edge profiles Drawer front #51 only

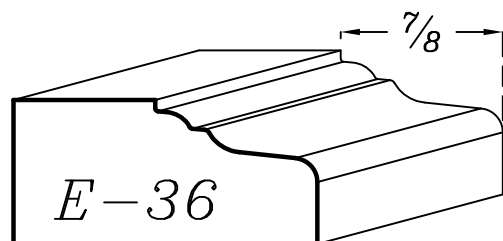
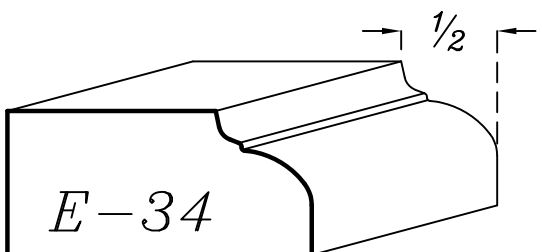
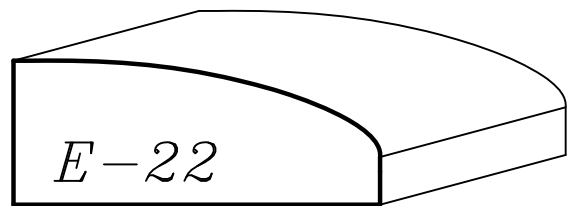
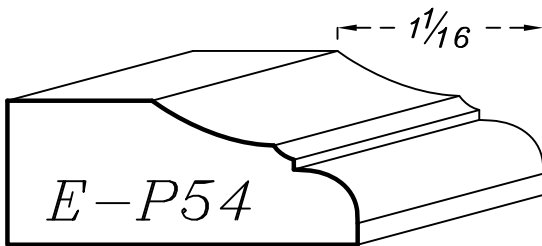
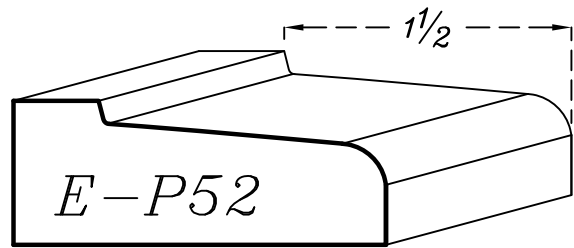
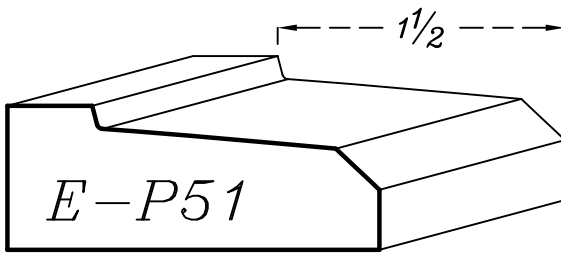
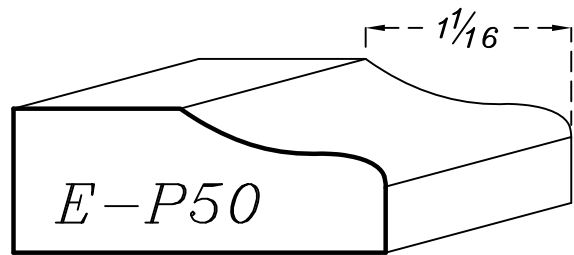
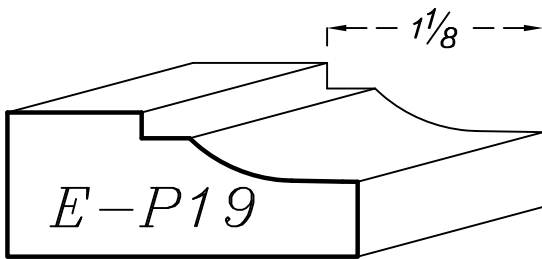
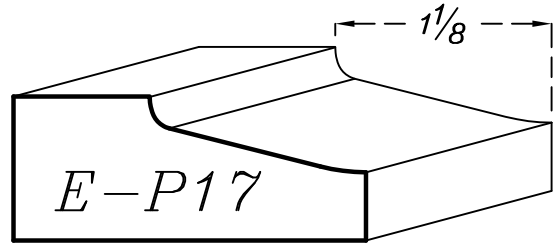
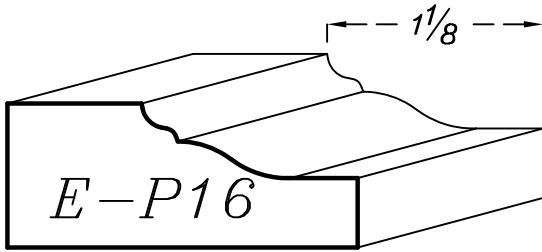

Profiles

Edge profiles Drawer front #54 only

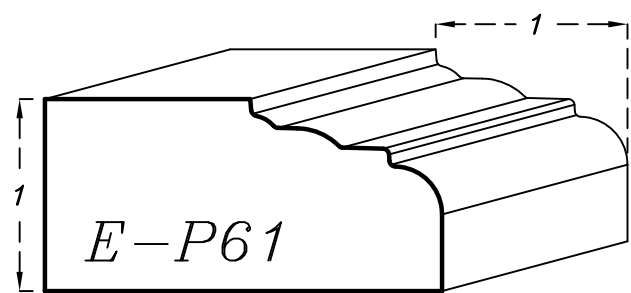
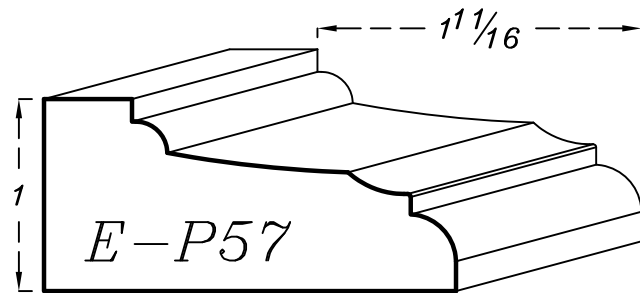
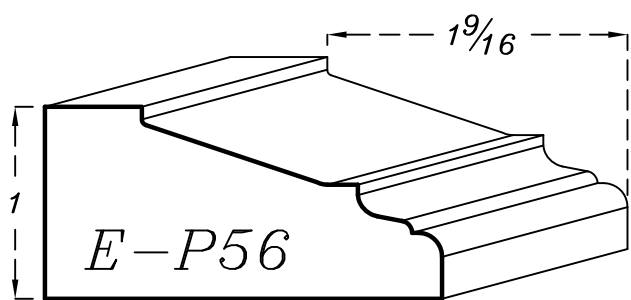
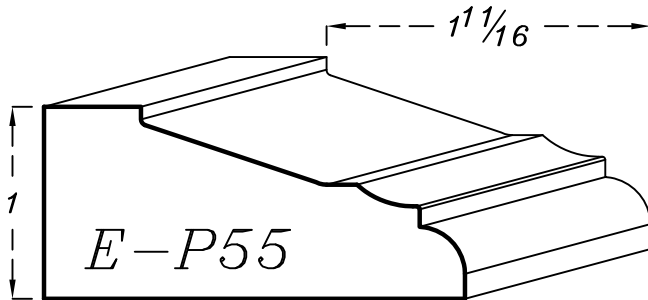
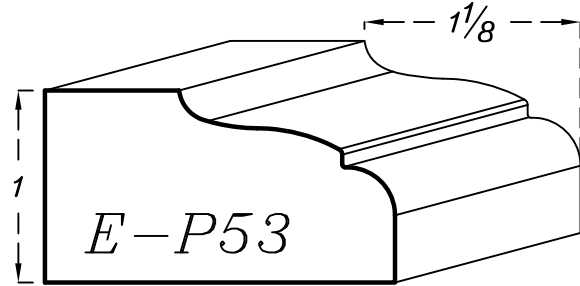
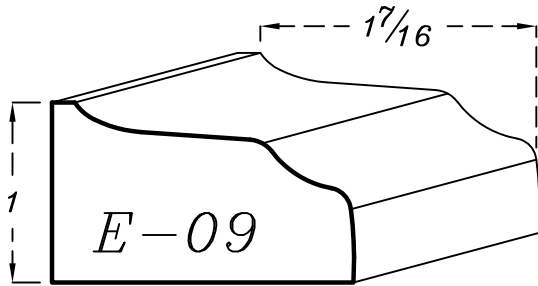

1	PROFILES
2	TRADITIONAL 90
3	DISTINCTIVE 90
4	CATHEDRAL 90
5	APPLIED MOULDINGS
6	PRESTIGE 45
7	WAINSCOTS
8	SPECIALTY PRODUCTS
9	MOULDINGS
10	PROMOTIONAL ITEMS
11	POLICY

Profiles

Edge profiles

Drawer front #51, #54 and 1" only doors

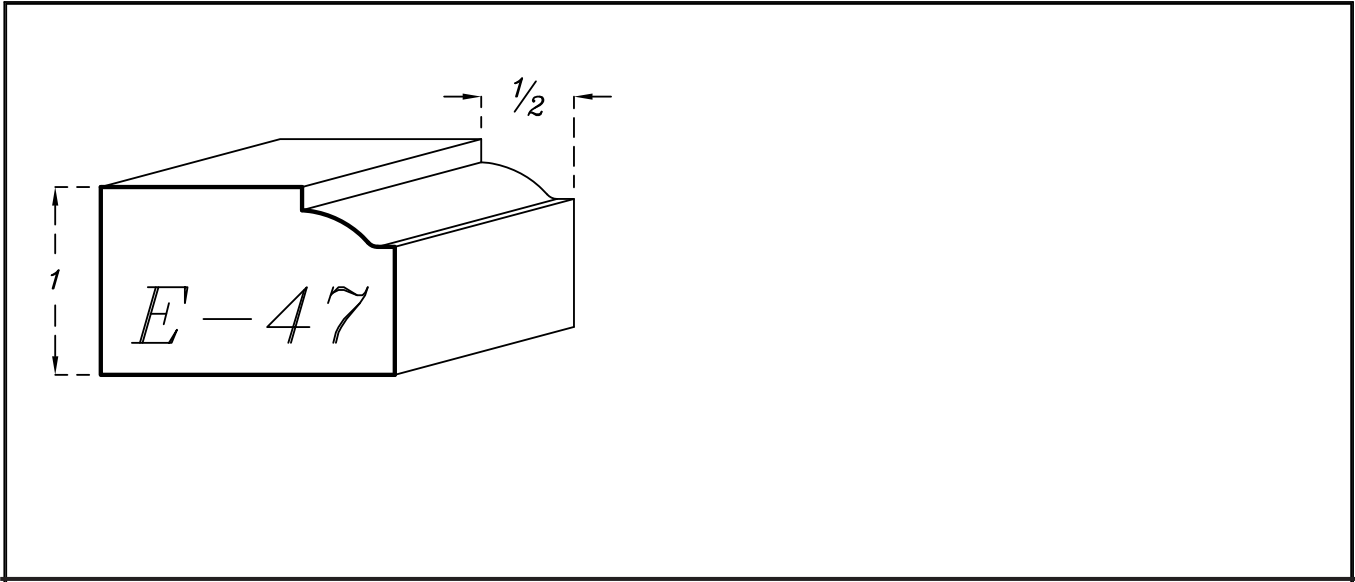

GOBER
cabinet doors

Notes

Doors

Traditional series

<i>Charter</i>		
<i>Width of rails and stiles</i>	<i>Corresponding models</i>	<i>Page</i>
2"	11600	60
2 1/4"	500	53
2 1/4"	11000 <i>Reverse door</i>	58
2 3/8"	12000	63
2 1/2"	100	52
2 3/4"	11800	61
2 7/8"	12700	65
2 7/8"	12100 <i>Reverse door</i>	64
3"	800	54
3"	11100 <i>Reverse door</i>	59
3 1/4"	900	56
3 1/2"	10700	57
3 3/4"	830	55
4"	11900	62

DOOR OPTIONS

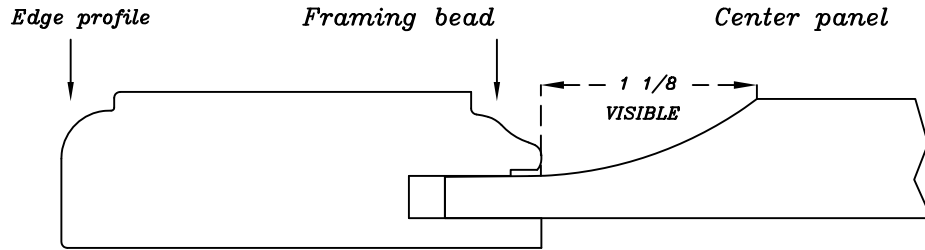

OPTIONS

?	Edge profiles	E-01 to E-58			
?	Framing beads	A/B/F/G/J/K/L/M/N/P/Q R/T/U/V/W/X/Z/2/3/5	C/D/O/Y/4/7	E/H/S	
?	Center panel profiles	Solid	P-01 to P-65	S-01 to S-17	P-23
		Veneer	V-01 to V-21	V-01 to V-21	V-05 to V-07
		MDF	M-01 to M-75 M-V1 to M-V3	M-51 to M-517 M-V1 to M-V3	M-V5 to M-V7

FRAME OPTIONS

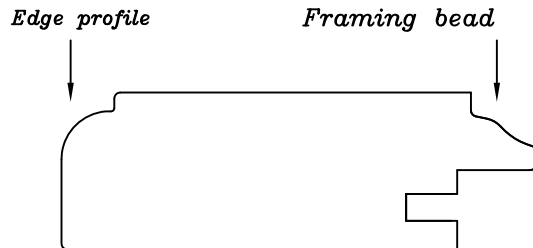

OPTIONS

?	Edge profiles	E-01 to E-58
?	Framing beads	A/B/C/D/E/F/G/H/J/K/L/M/N/O/P Q/R/S/T/U/V/W/X/Y/Z/2/3/4/5/7

Drawer options

Traditional series

1 PROFILES
2 TRADITIONAL 90
3 DISTINCTIVE 90
4 CATHEDRAL 90
5 APPLIED MOULDINGS
6 PRESTIGE 45
7 WAINSCOTS
8 SPECIALTY PRODUCTS
9 MOULDINGS
10 PROMOTIONAL ITEMS
11 POLICY

FRONT DRAWER SLAB: # 51/?

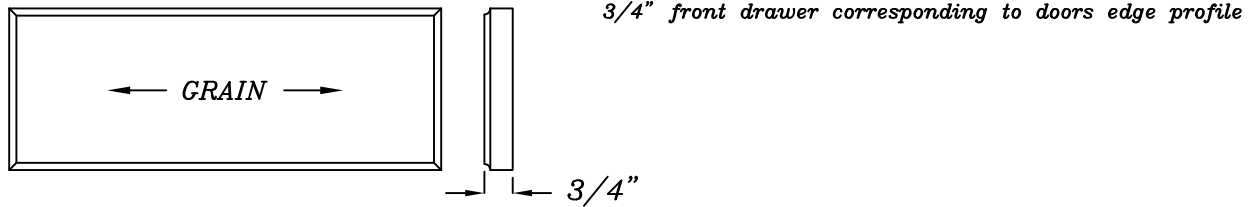

OPTIONS

? Edge profiles	E-01 to E-48; EP-01 to EP-53
-----------------	------------------------------

FRONT DRAWER SLAB: # 54/?

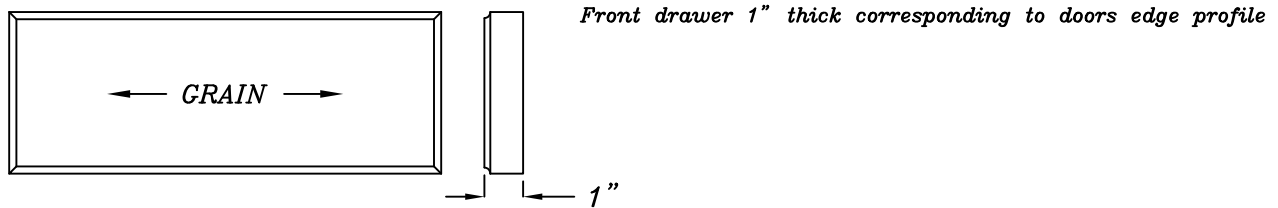

OPTIONS

? Edge profiles	E-01 to E-58; EP-01 to EP-53
-----------------	------------------------------

SLAB: # 503/?

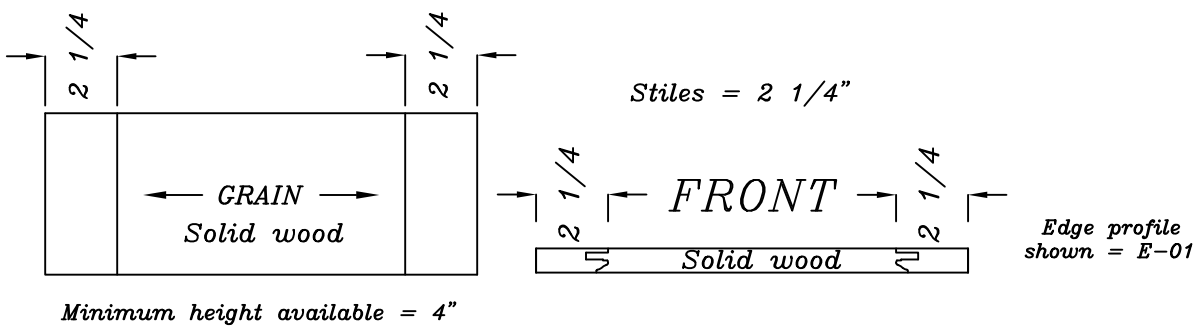

3 piece front drawer corresponding doors edge profile

OPTIONS

? Edge profiles	E-01 to E-58
-----------------	--------------

Drawer options

Traditional series

SLAB: # 803/?

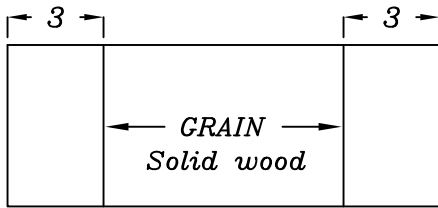

Stiles = 3"



Edge profile shown = E-01

Minimum height available = 4"

3 piece front drawer corresponding doors edge profile

OPTIONS

?	Edge profiles	E-01 to E-58
---	---------------	--------------

SLAB: # 11803/?

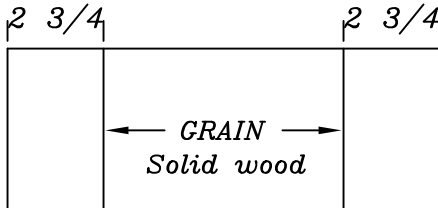

Stiles = 2 3/4"



Edge profile shown = E-01

Minimum height available = 4"

3 piece front drawer corresponding doors edge profile

OPTIONS

?	Edge profiles	E-01 to E-58
---	---------------	--------------

Glass dimension

Width of glass

$$\textcircled{L} - (\textcircled{A} + \textcircled{B}) + 11/16 = \text{width of glass}$$

EX: $12 - (2 \frac{1}{4} + 2 \frac{1}{4}) + 11/16 = 8 \frac{3}{16}$

Height of glass

$$\textcircled{H} - (\textcircled{C} + \textcircled{D}) + 11/16 = \text{height of glass}$$

EX: $24 - (2 \frac{1}{4} + 2 \frac{1}{4}) + 11/16 = 20 \frac{3}{16}$

This calculation leaves a tolerance between $\frac{1}{16}$ " and $\frac{1}{8}$ "

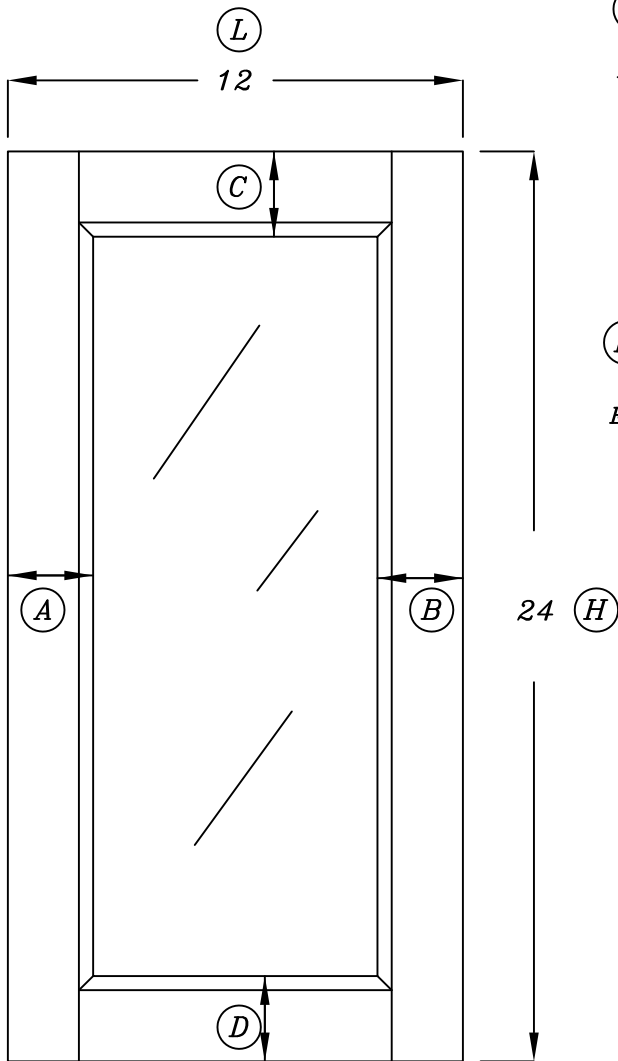

Traditional series

FRENCH

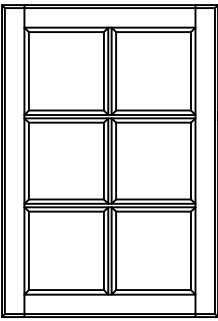

MULLION ALIGNMENT

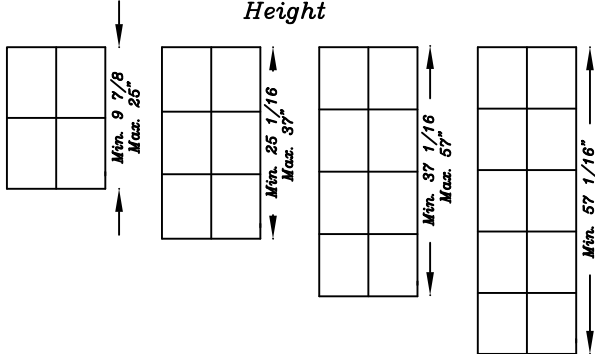

Width

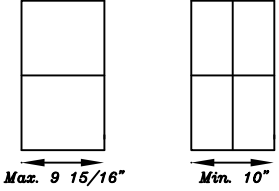

OPTIONS

? Edge profiles	E-01 to E-58
? Framing beads	A/B/C/D/E/F/G/H/J/K/L/M/N/O/P Q/R/S/T/U/V/W/X/Y/Z/2/3/4/5/7
? Amount of tiles	0/2/3/4/6/8/9/10

PRAIRIE

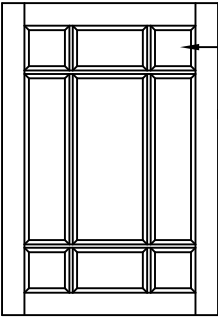

Specify desired lite size
(min. 1 1/2" x 1 1/2")
unless specified
tiles will be produced 3" x 3"

- 1 PROFILES
- 2 TRADITIONAL 90
- 3 DISTINCTIVE 90
- 4 CATHEDRAL 90
- 5 APPLIED MOULDINGS
- 6 PRESTIGE 45
- 7 WAINSCOTS
- 8 SPECIALITY PRODUCTS
- 9 MOULDINGS
- 10 PROMOTIONAL ITEMS
- 11 POLICY

Frame options

Traditional series

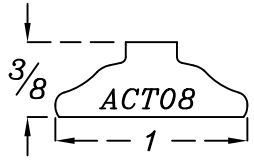
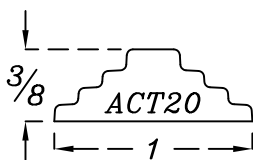
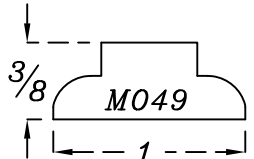
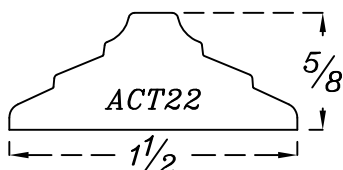
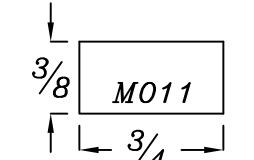
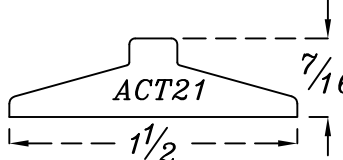
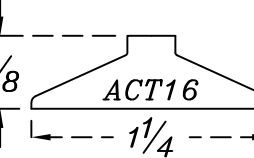
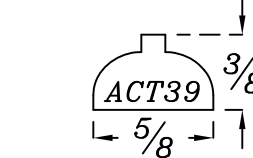
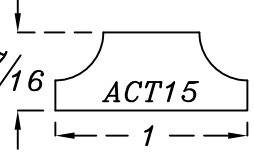
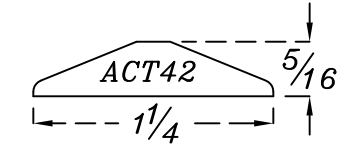
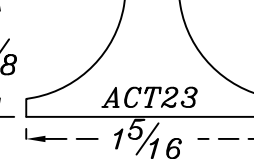
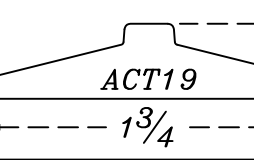
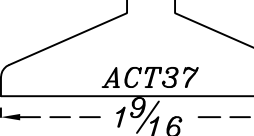
Mullions models	Framing beads	Mullions models	Framing beads
 <p>ACT08</p>	A/F/G/M/P/W	 <p>ACT20</p>	V
 <p>M049</p>	B	 <p>ACT22</p>	X
 <p>M011</p>	C/D/E/H/J/N/O Q/S/Y/3/4/5	 <p>ACT21</p>	Z
 <p>ACT16</p>	K	 <p>ACT39</p>	2
 <p>ACT15</p>	L	 <p>ACT42</p>	7
 <p>ACT23</p>	R		
 <p>ACT19</p>	T		
 <p>ACT37</p>	U		

- 1 PROFILES
- 2 TRADITIONAL 90
- 3 DISTINCTIVE 90
- 4 CATHEDRAL 90
- 5 APPLIED MOULDINGS
- 6 PRESTIGE 45
- 7 WAINSCOTS
- 8 SPECIALTY PRODUCTS
- 9 MOULDINGS
- 10 PROMOTIONAL ITEMS
- 11 POLICY

Doors

Traditional series

DOOR # 100/???

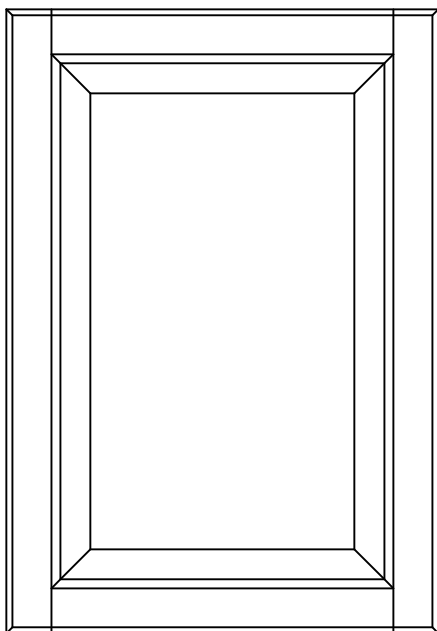

Minimum height and width (Solid) = 7 1/2"
Minimum height and width (Veneer) = 6 1/8"

FRAME # 105/???

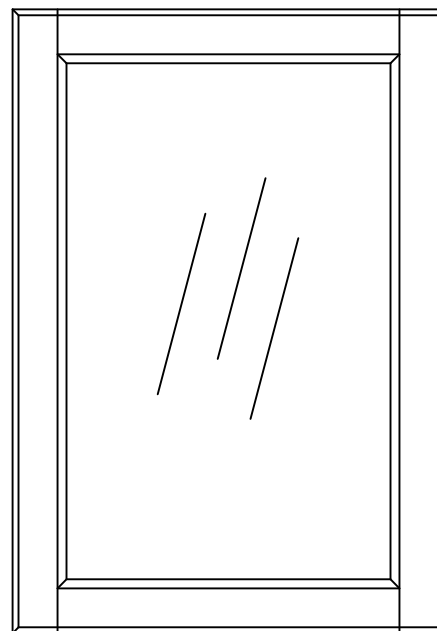

Minimum height and width = 6 1/8"

Edge profile shown = E-04

Framing bead shown = A

Center panel shown = P-03

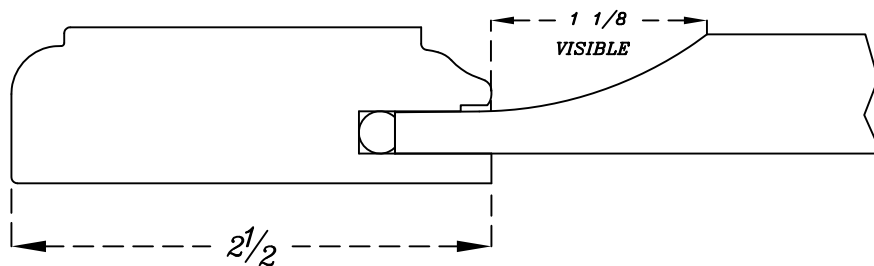

5-PIECE DRAWER FRONT: # 101/???

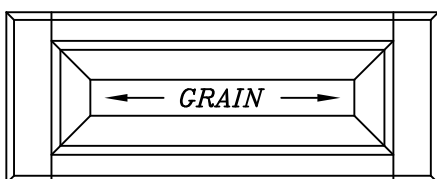

Minimum height available = 5 3/4"
Minimum width available = 7 3/4"
(With 1/8" of visible panel)

Stiles = 2 1/2"
Rails = 1 1/2"

5-piece drawer front matches edge profile framing bead and center panel profile

DOOR # 500/???

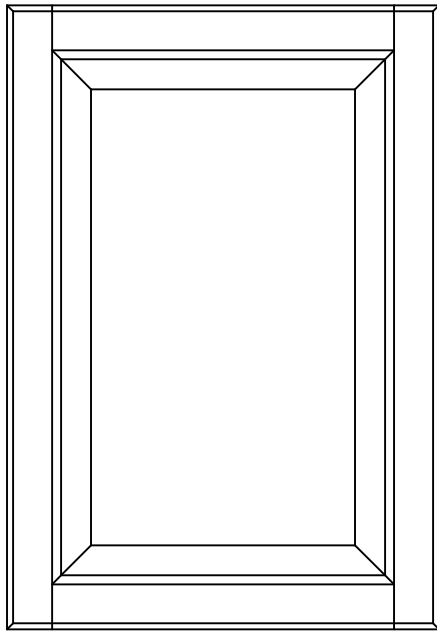

Minimum height and width (Solid) = 7"
Minimum height and width (Veneer) = 5 5/8"

FRAME # 505/???

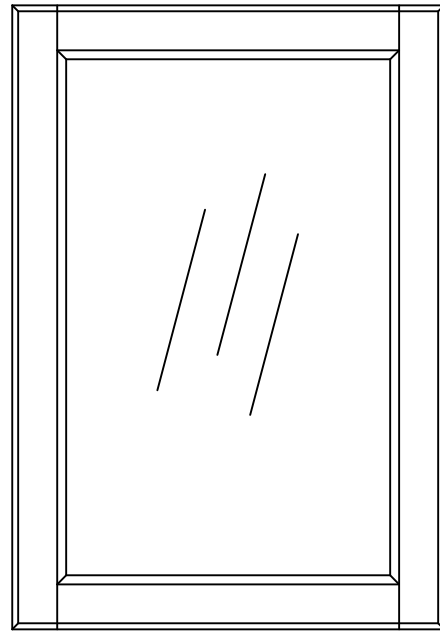

Minimum height and width = 5 5/8"

Edge profile shown = E-04

Framing bead shown = A

Center panel shown = P-03

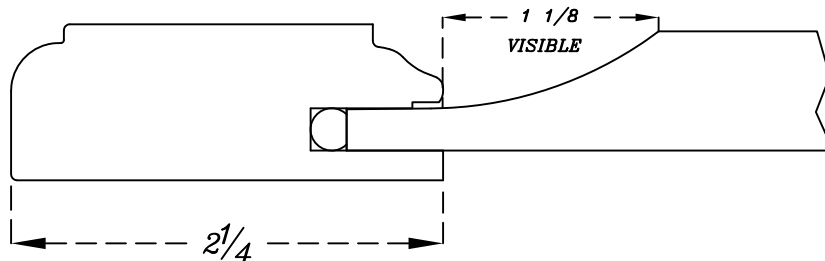

5-PIECE DRAWER FRONT: # 501/???

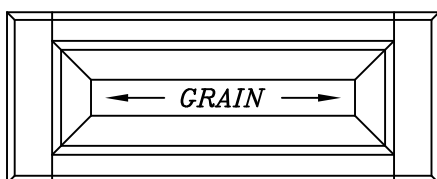

Minimum height available = 5 7/8"
Minimum width available = 7 1/4"
(With 1 1/8" of visible panel)

Stiles = 2 1/4"
Rails = 1 9/16"

5-piece drawer front matches edge profile framing bead and center panel profile

Doors

Traditional series

DOOR # 800/???

FRAME # 805/???

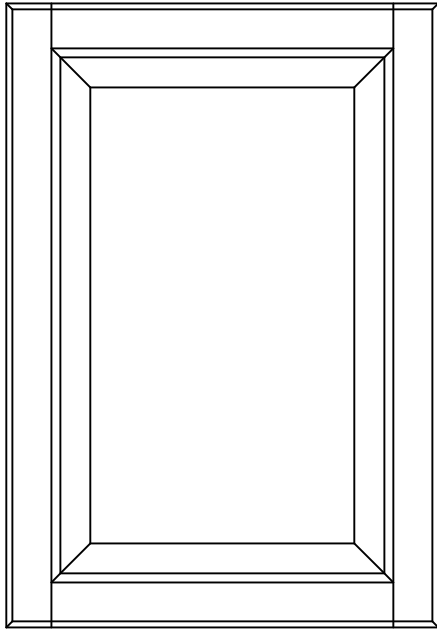

Minimum height and width (Solid) = 8 1/2"
Minimum height and width (Veneer) = 7 1/8"

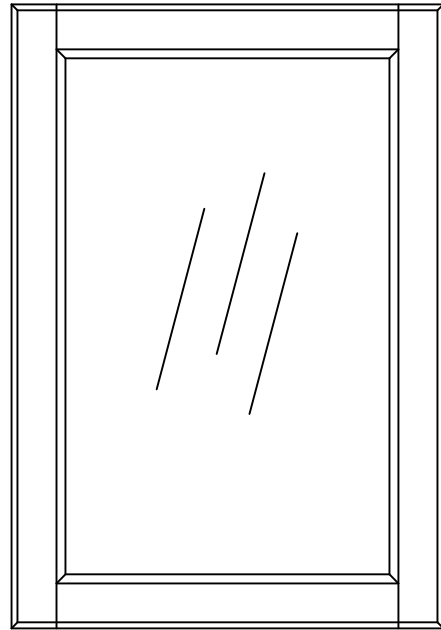

Minimum height and width = 7 1/8"

Edge profile shown = E-04

Framing bead shown = A

Center panel shown = P-03

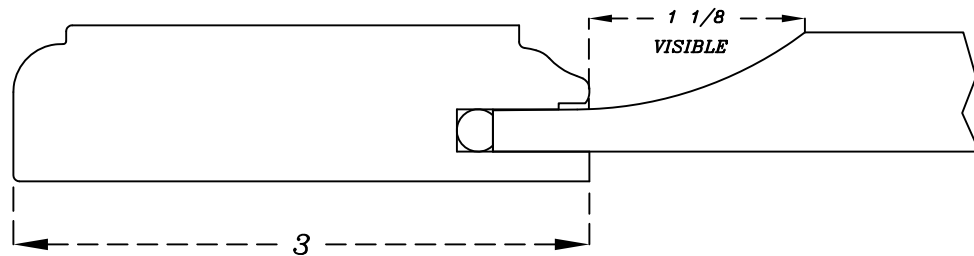

5-PIECES DRAWER FRONT: # 801/???

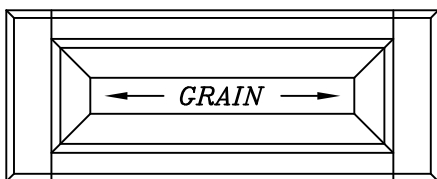

Minimum height available = 5 7/8"
Minimum width available = 8 3/4"
(With 1/8" of visible panel)

Stiles = 3"
Rails = 1 9/16"

5-pieces drawer front matches edge profile framing bead and center panel profile

Doors

Traditional series

- 1 PROFILES
- 2 TRADITIONAL 90
- 3 DISTINCTIVE 90
- 4 CATHEDRAL 90
- 5 APPLIED MOULDINGS
- 6 PRESTIGE 45
- 7 WANSCOTTS
- 8 SPECIALTY PRODUCTS
- 9 MOULDINGS
- 10 PROMOTIONAL ITEMS
- 11 POLICY

DOOR # 830/???

FRAME # 835/???

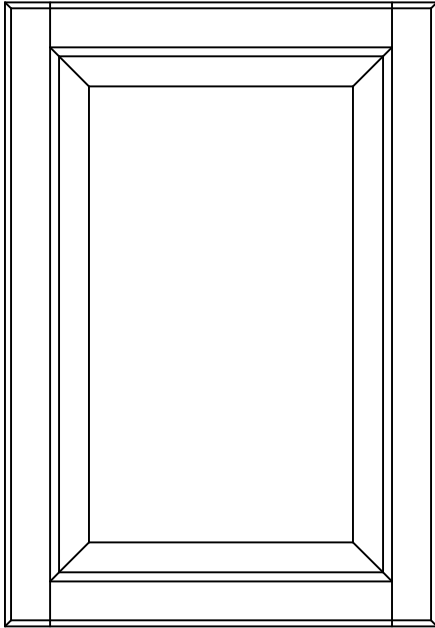

*Minimum height and width (Solid) = 10"
Minimum height and width (Veneer) = 8 5/8"*

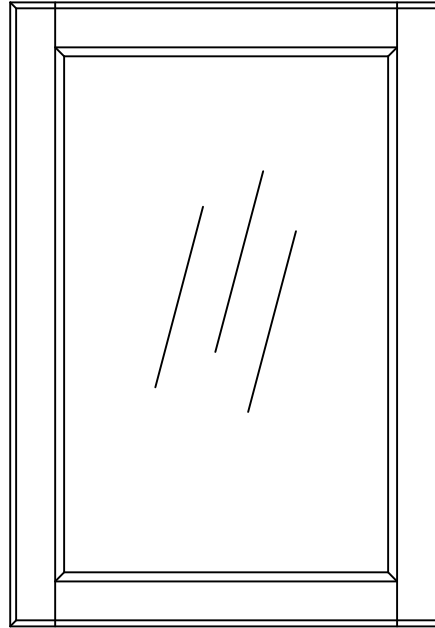

Minimum height and width = 8 5/8"

Edge profile shown = E-04

Framing bead shown = A

Center panel shown = P-03

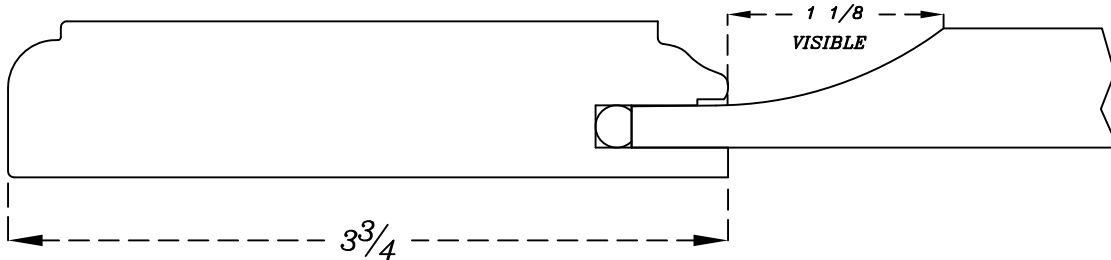

5-PIECES DRAWER FRONT: # 831/???

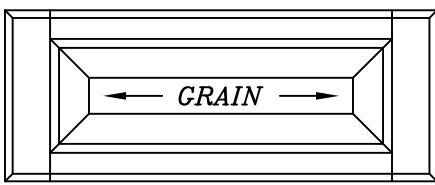

*Minimum height available = 5 7/8"
Minimum width available = 10 1/4"
(With 1 1/8" of visible panel)*

*Stiles = 3 3/4"
Rails = 1 9/16"*

5-pieces drawer front matches edge profile framing bead and center panel profile

Doors

Traditional series

DOOR # 900/???

FRAME # 905/???

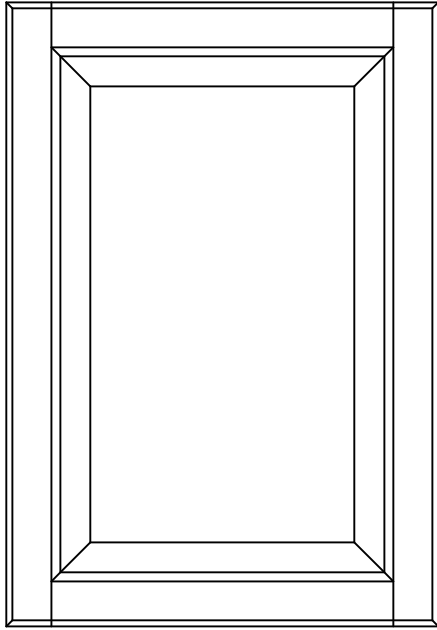

Minimum height and width (Solid) = 9"
Minimum height and width (Veneer) = 7 5/8"

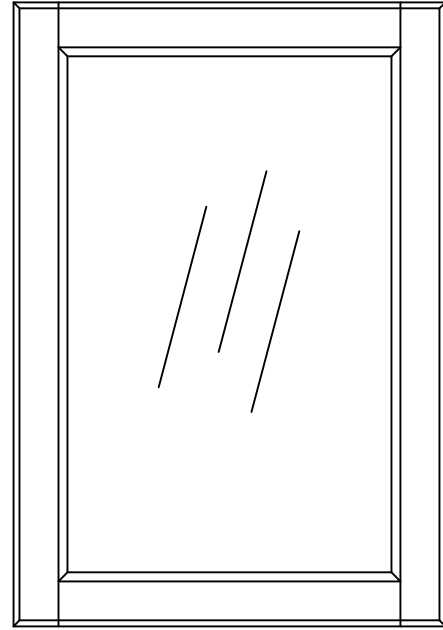

Minimum height and width = 7 5/8"

Edge profile shown = E-04

Framing bead shown = A

Center panel shown = P-03

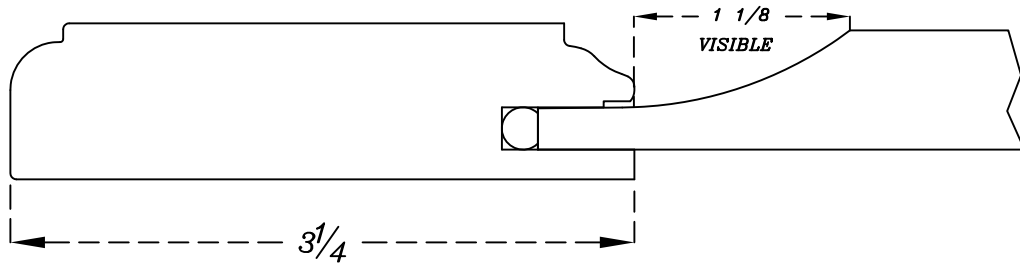

5-PIECES DRAWER FRONT: # 901/???

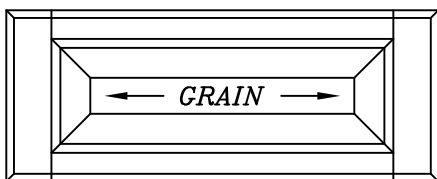

Minimum height available = 5 7/8"
Minimum width available = 9 1/4"
(With 1/8" of visible panel)

Stiles = 3 1/4"
Rails = 1 9/16"

5-pieces drawer front matches edge profile framing bead and center panel profile

Doors

Traditional series

- 1 PROFILES
- 2 TRADITIONAL 90
- 3 DISTINCTIVE 90
- 4 CATHEDRAL 90
- 5 APPLIED MOULDINGS
- 6 PRESTIGE 45
- 7 WANSCOTS
- 8 SPECIALTY PRODUCTS
- 9 MOULDINGS
- 10 PROMOTIONAL ITEMS
- 11 POLICY

DOOR # 10700/???

FRAME # 10705/???

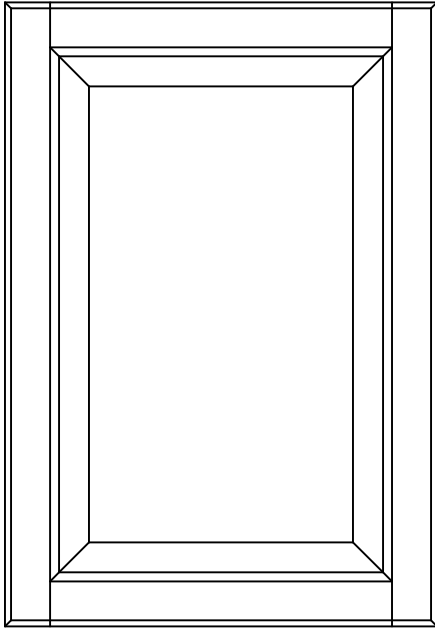

Minimum height and width (Solid) = $9 \frac{1}{2}$ "
 Minimum height and width (Veneer) = $8 \frac{1}{8}$ "

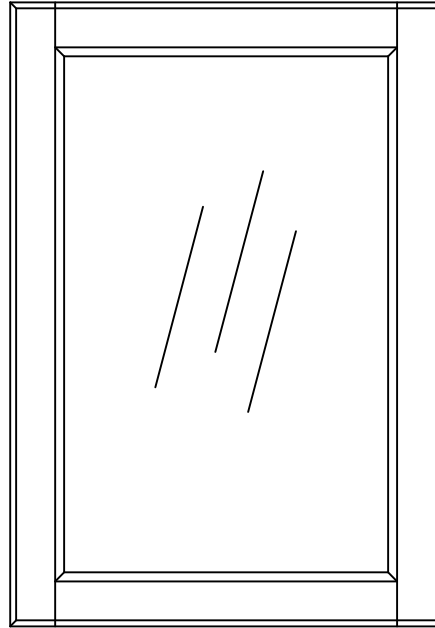

Minimum height and width = $8 \frac{1}{8}$ "

Edge profile shown = E-04

Framing bead shown = A

Center panel shown = P-03

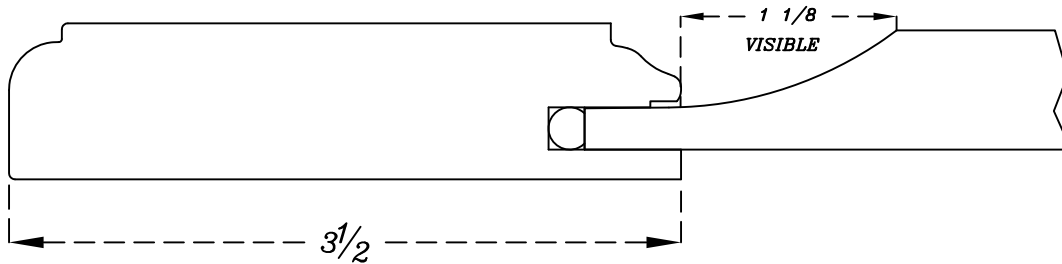

5-PIECES DRAWER FRONT: # 10701/???

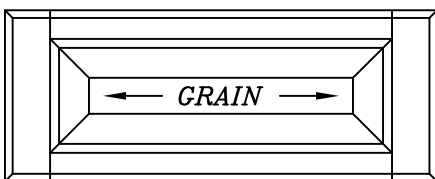

Minimum height available = $5 \frac{7}{8}$ "
 Minimum width available = $9 \frac{3}{4}$ "
 (With $1 \frac{1}{8}$ " of visible panel)

Stiles = $3 \frac{1}{2}$ "
 Rails = $1 \frac{9}{16}$ "

5-pieces drawer front matches edge profile framing bead and center panel profile

Doors

Traditional series

DOOR # 11000/???

FRAME # 11005/???

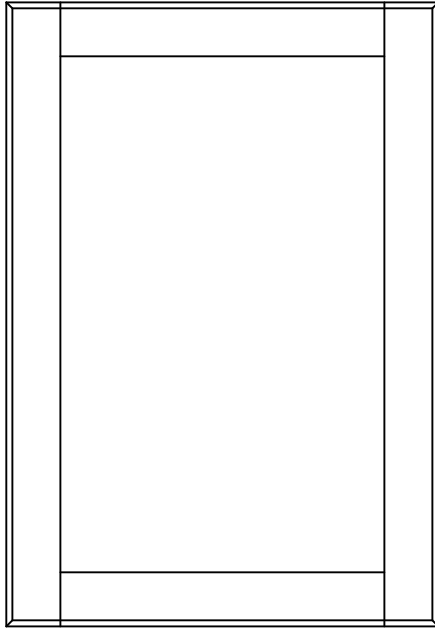

Minimum height and width (Solid) = 7"
Minimum height and width (Veneer) = 5 5/8"

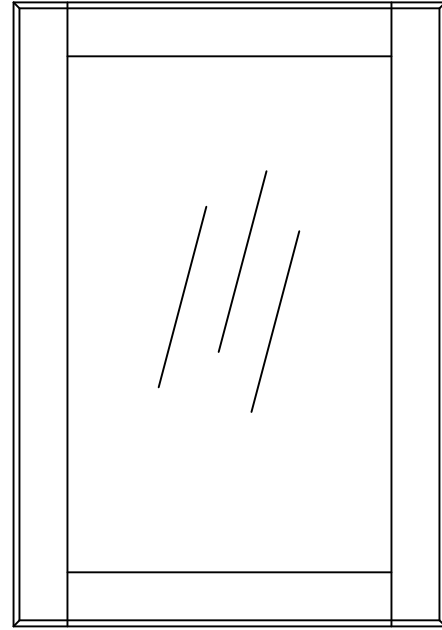

Minimum height and width = 5 5/8"

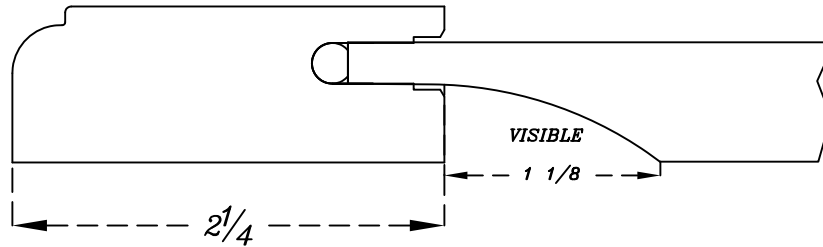

5-PIECES DRAWER FRONT: # 11001/???

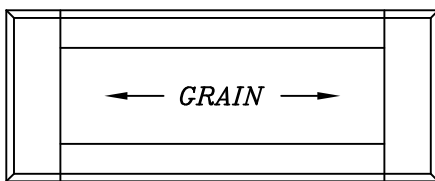

Minimum height available = 5 7/8"
Minimum width available = 7 1/4"
(With 1 1/8" of visible panel)

Stiles = 2 1/4"
Rails = 1 9/16"

5-pieces drawer front matches edge profile framing bead and center panel profile

Doors

Traditional series

- 1 PROFILES
- 2 TRADITIONAL 90
- 3 DISTINCTIVE 90
- 4 CATHEDRAL 90
- 5 APPLIED MOULDINGS
- 6 PRESTIGE 45
- 7 WANNSCOTS
- 8 SPECIALTY PRODUCTS
- 9 MOULDINGS
- 10 PROMOTIONAL ITEMS
- 11 POLICY

DOOR # 11100/???

FRAME # 11105/???

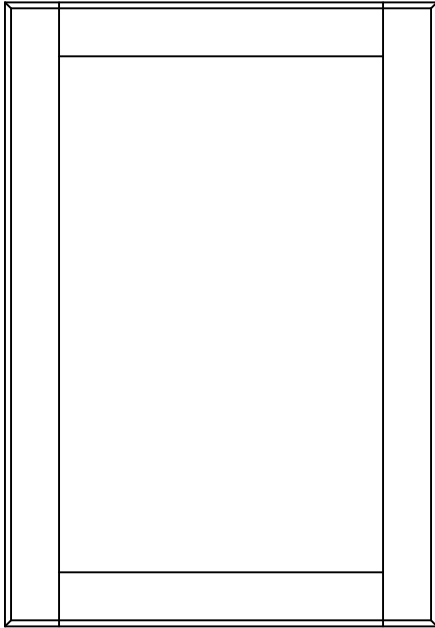

Minimum height and width (Solid) = 8 1/2"
Minimum height and width (Veneer) = 7 1/8"

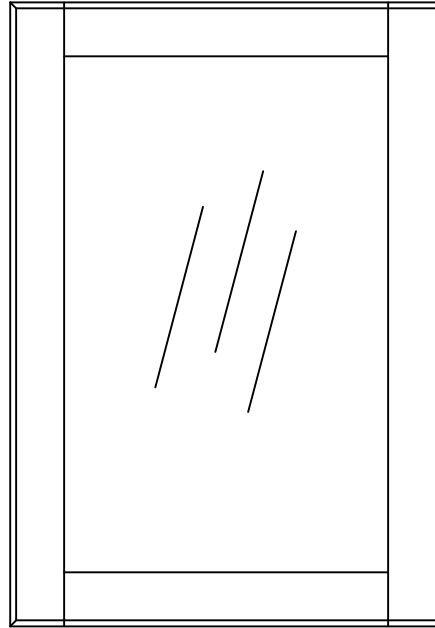

Minimum height and width = 7 1/8"

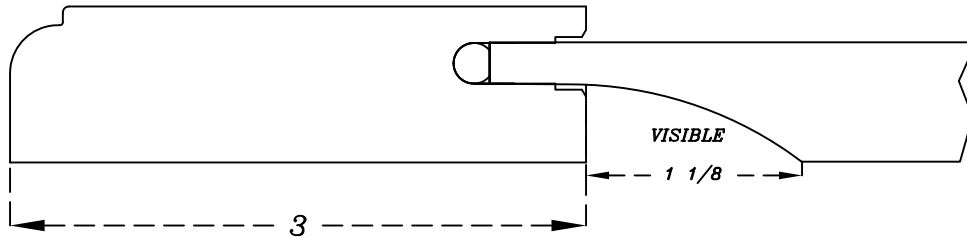

5-PIECES DRAWER FRONT: # 11101/???

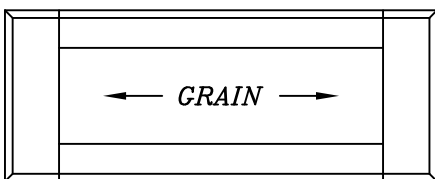

Minimum height available = 5 7/8"
Minimum width available = 8 3/4"
(With 1/8" of visible panel)

Stiles = 3"
Rails = 1 9/16"

5-pieces drawer front matches edge profile framing bead and center panel profile

Doors

Traditional series

DOOR # 11600/???

FRAME # 11605/???

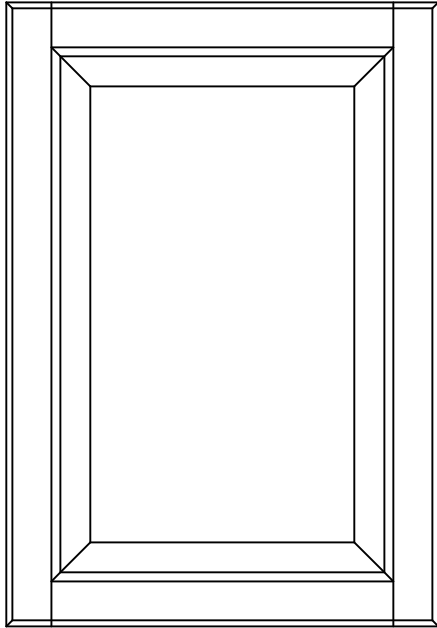

Minimum height and width (Solid) = 6 1/2"
Minimum height and width (Veneer) = 5 1/8"

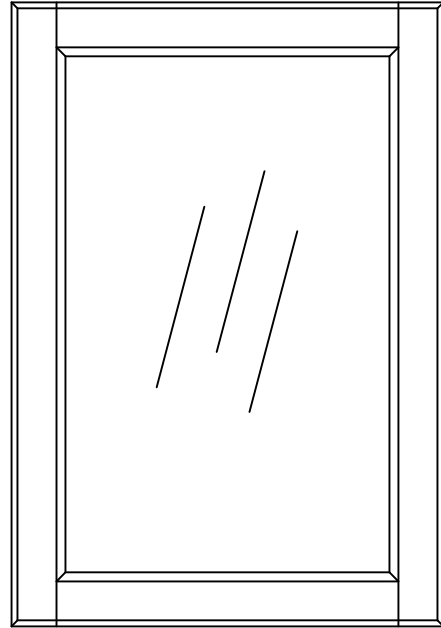

Minimum height and width = 5 1/8"

Edge profile shown = E-04

Framing bead shown = A

Center panel shown = P-03

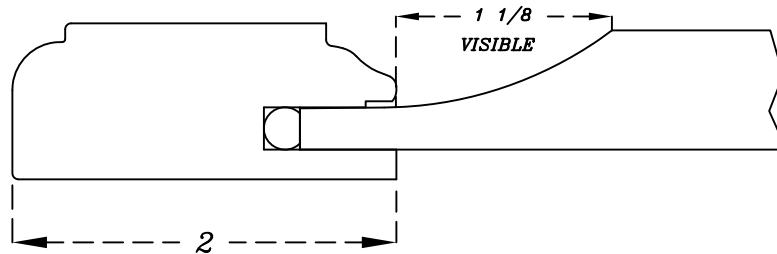

5-PIECES DRAWER FRONT: # 11601/???

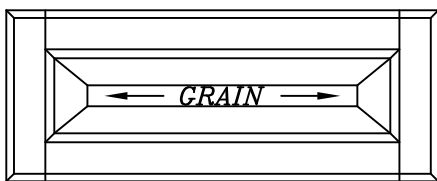

Minimum height available = 6 3/4"
Minimum width available = 6 3/4"
(With 1/8" of visible panel)

Stiles = 2"
Rails = 2"

5-pieces drawer front matches edge profile framing bead and center panel profile

Doors

Traditional series

DOOR # 11800/???

FRAME # 11805/???

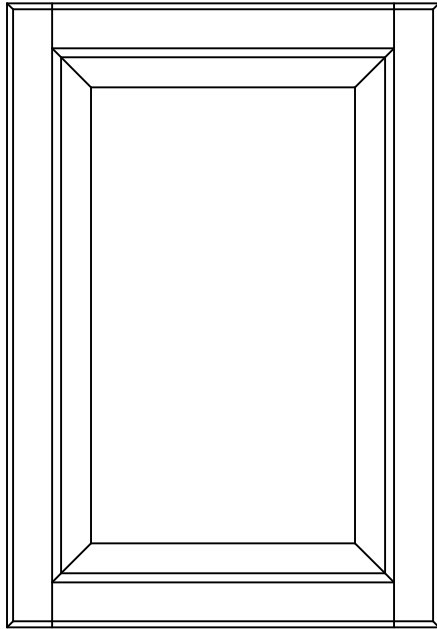

Minimum height and width (Solid) = 8"
Minimum height and width (Veneer) = 7"

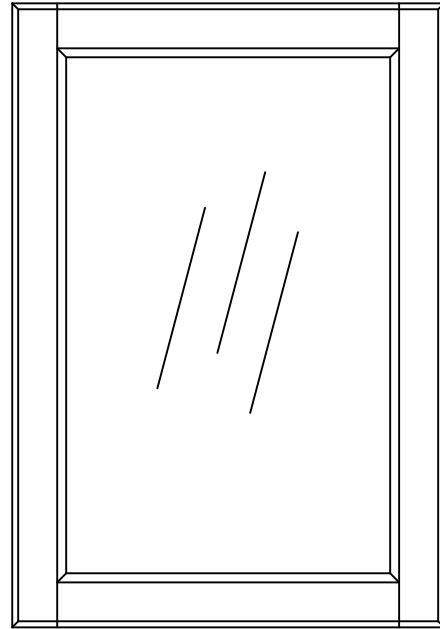

Minimum height and width = 7"

Edge profile shown = E-04

Framing bead shown = A

Center panel shown = P-03

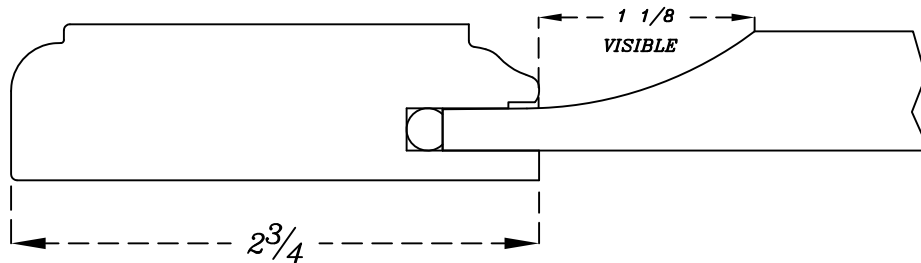

5-PIECE DRAWER FRONT: # 11801/???

Stiles = 2 3/4"
Standard rails 2"
Optional rails 1 1/2"

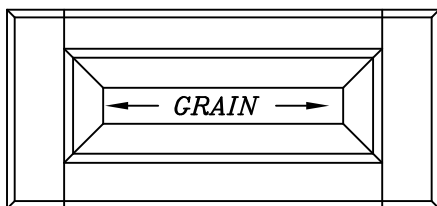

Minimum height available = 6 3/4"
Minimum width available = 8 1/4"
(With 1 1/8" of visible panel)

If the option 1 1/2" is not specified
drawer will be produced at 2"

5-piece drawer front matches edge profile
framing bead and center panel profile

- 1 PROFILES
- 2 TRADITIONAL 90
- 3 DISTINCTIVE 90
- 4 CATHEDRAL 90
- 5 APPLIED MOULDINGS
- 6 PRESTIGE 45
- 7 WAINSCOTS
- 8 SPECIALTY PRODUCTS
- 9 MOULDINGS
- 10 PROMOTIONAL ITEMS
- 11 POLICY

Doors

Traditional series

DOOR # 11900/???

FRAME # 11905/???

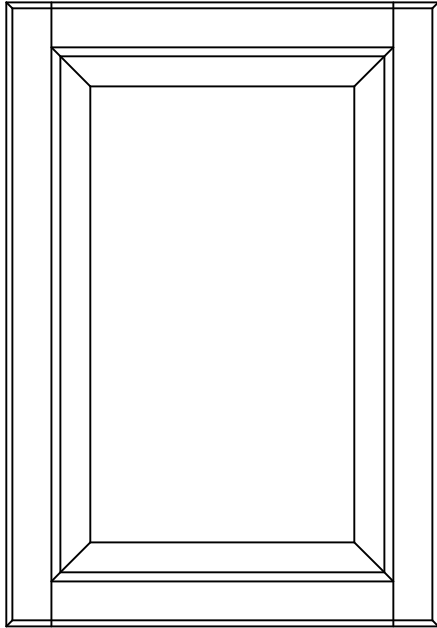

Minimum height and width (Solid) = 10 1/2"
Minimum height and width (Veneer) = 9 1/8"

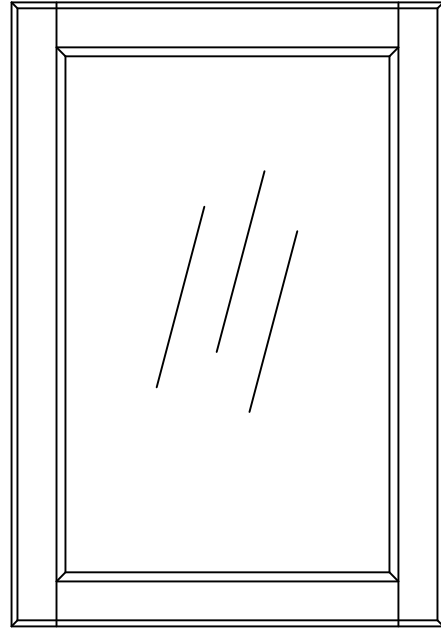

Minimum height and width = 9 1/8"

Edge profile shown = E-04

Framing bead shown = A

Center panel shown = P-03

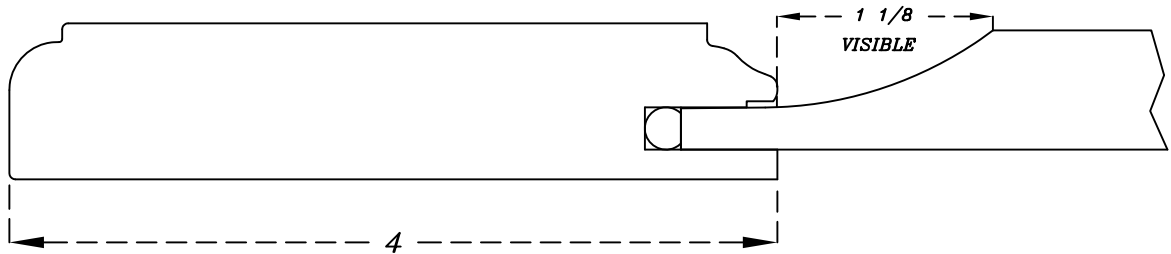

5-PIECES DRAWER FRONT: # 11901/???

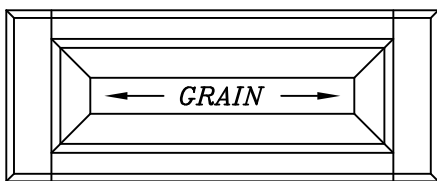

Minimum height available = 5 7/8"
Minimum width available = 10 3/4"
(With 1 1/8" of visible panel)

Stiles = 4"
Rails = 1 9/16"

5-pieces drawer front matches edge profile framing bead and center panel profile

Doors

Traditional series

- 1 PROFILES
- 2 TRADITIONAL 90
- 3 DISTINCTIVE 90
- 4 CATHEDRAL 90
- 5 APPLIED MOULDINGS
- 6 PRESTIGE 45
- 7 WANNSCOTS
- 8 SPECIALTY PRODUCTS
- 9 MOULDINGS
- 10 PROMOTIONAL ITEMS
- 11 POLICY

DOOR # 12000/???

FRAME # 12005/???

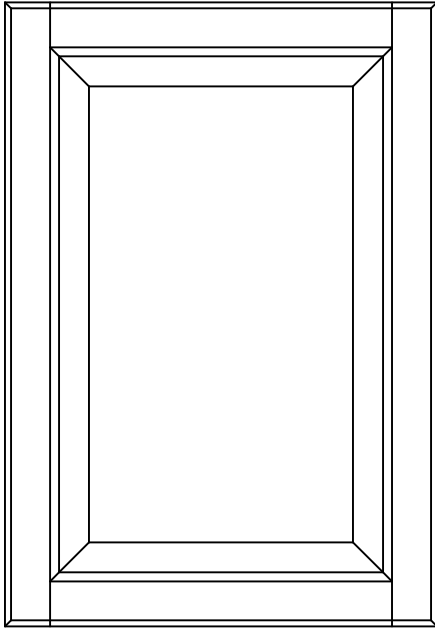

*Minimum height and width (Solid) = 7 1/4"
Minimum height and width (Veneer) = 5 7/8"*

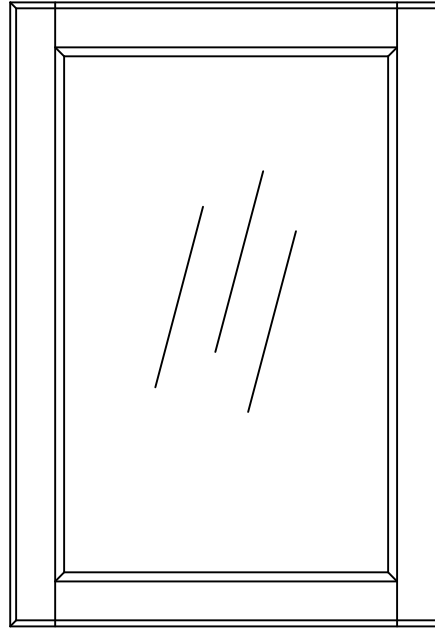

Minimum height and width = 5 5/8"

Edge profile shown = E-04

Framing bead shown = A

Center panel shown = P-03

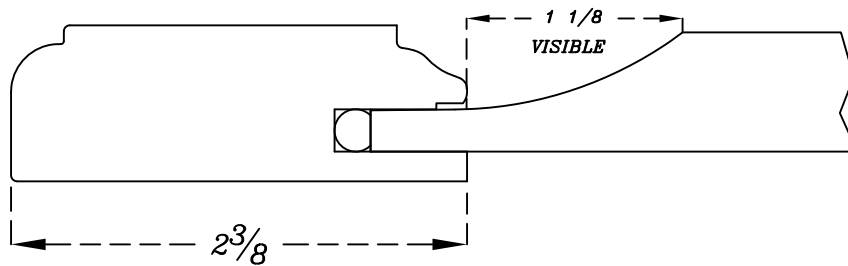

5-PIECES DRAWER FRONT: # 12001/???

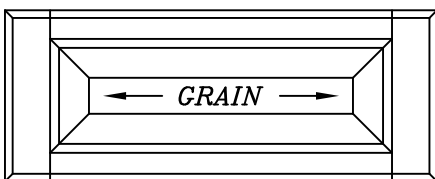

*Minimum height available = 5 3/4"
Minimum width available = 7 1/2"
(With 1/8" of visible panel)*

*Stiles = 2 3/8
Rails = 1 1/2"*

5-pieces drawer front matches edge profile framing bead and center panel profile

Doors

Traditional series

DOOR # 12100/???

FRAME # 12105/???

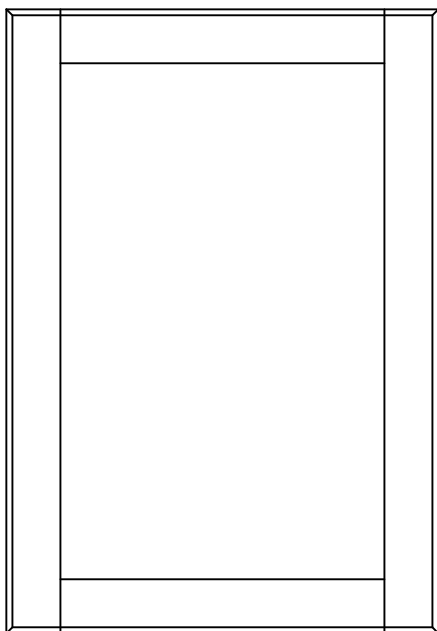

Minimum height and width (Solid) = 8 1/4"
Minimum height and width (Veneer) = 6 7/8"

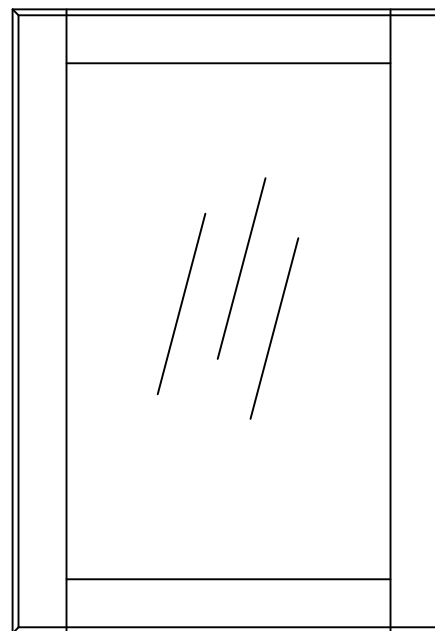

Minimum height and width = 6 7/8"

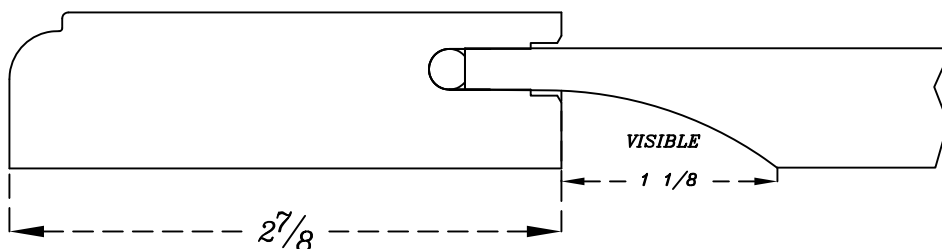

5-PIECE DRAWER FRONT: # 12101/???

Stiles = 2 7/8"
Standard rails 1 5/8"
Optional rails 2 7/16"

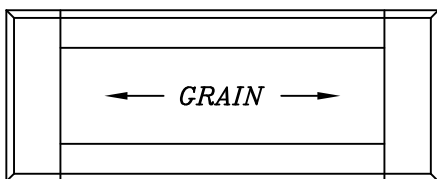

Minimum height available = 6"
Minimum width available = 8 1/2"
(With 1 1/8" of visible panel)

If the option 2 7/16" is not specified
drawer will be produced at 1 5/8"

5-piece drawer front matches edge profile
framing bead and center panel profile

Doors

Traditional series

- 1 PROFILES
- 2 TRADITIONAL 90
- 3 DISTINCTIVE 90
- 4 CATHEDRAL 90
- 5 APPLIED MOULDINGS
- 6 PRESTIGE 45
- 7 WAINSCOTS
- 8 SPECIALTY PRODUCTS
- 9 MOULDINGS
- 10 PROMOTIONAL ITEMS
- 11 POLICY

DOOR # 12700/???

FRAME # 12705/???

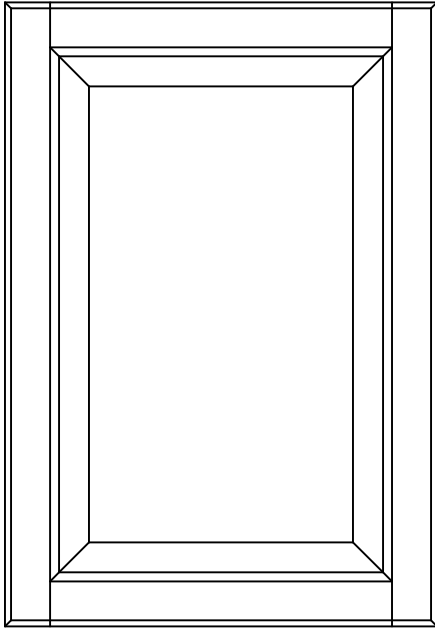

*Minimum height and width (Solid) = 8 1/4"
Minimum height and width (Veneer) = 7 1/4"*

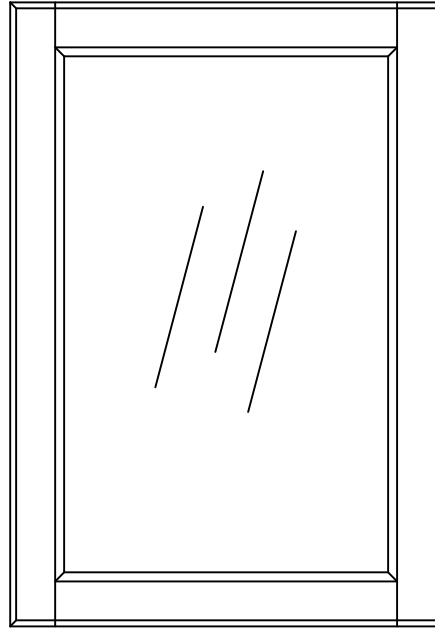

Minimum height and width = 7 1/4"

Edge profile shown = E-04

Framing bead shown = A

Center panel shown = P-03

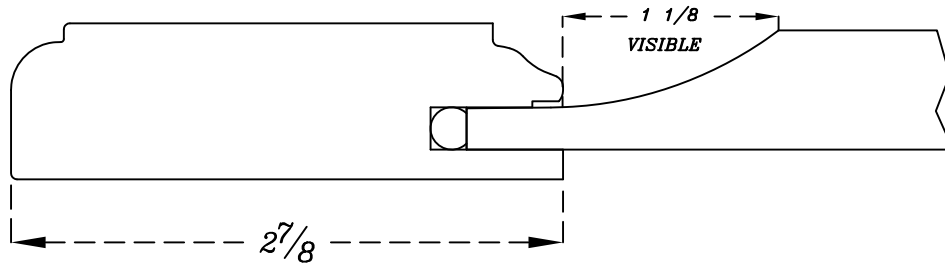

5-PIECES DRAWER FRONT: # 12701/???

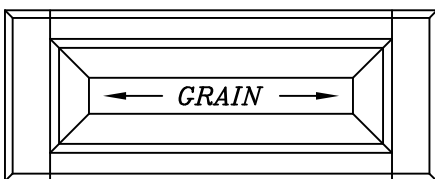

*Minimum height available = 5 7/8"
Minimum width available = 8 1/2"
(With 1 1/8" of visible panel)*

*Stiles = 2 7/8"
Rails = 1 9/16"*

5-pieces drawer front matches edge profile framing bead and center panel profile

DOOR OPTIONS

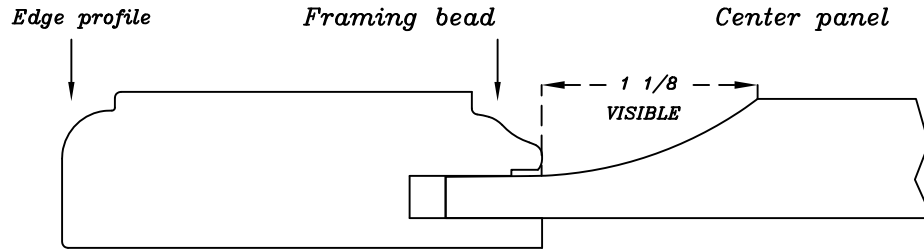

OPTIONS

?	Edge profiles	E-01 to E-58			
?	Framing beads	A/B/F/G/J/K/L/P	C	-	
?	Center panel profiles	Solid	P-01 to P-65	S-01 to S-17	-
		(veneer)	V-01 to V-21	V-01 to V-21	-
		MDF	M-01 to M-75	M-51 to M-517	-
		M-V1 to M-V3	M-V1 to M-V3	-	

FRAMES OPTIONS

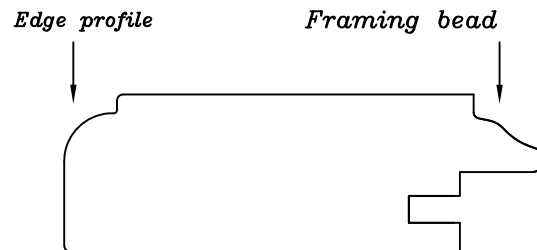

OPTIONS

?	Edge profiles	E-01 to E-58
?	Framing beads	A/B/C/F/G/J/K/L/P

Front Options

Distinctive series

FRONT DRAWER SLAB: # 51/?

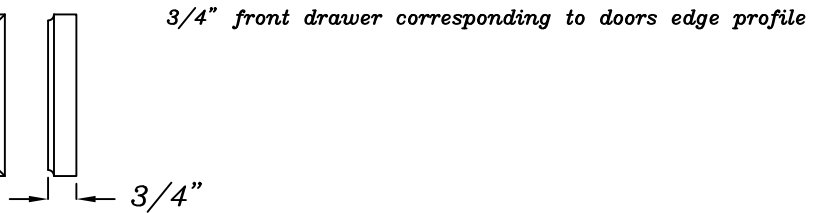
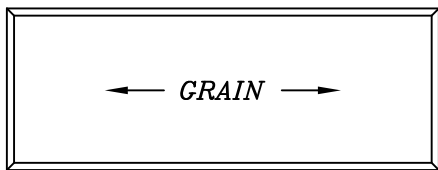

OPTIONS

? Edge profiles E-01 to E-48; EP-01 to EP-53

FRONT DRAWER SLAB: # 54/?

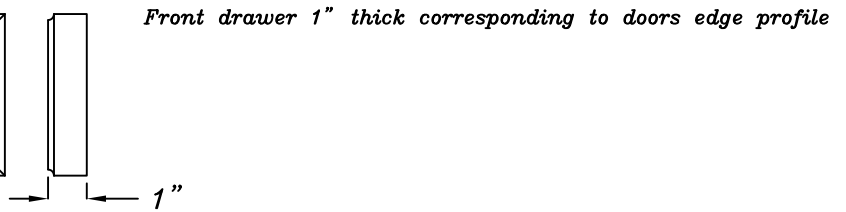
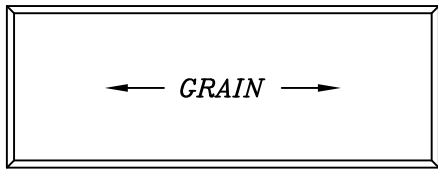

OPTIONS

? Edge profiles E-01 to E-58; EP-01 to EP-53

SLAB: # 503/?

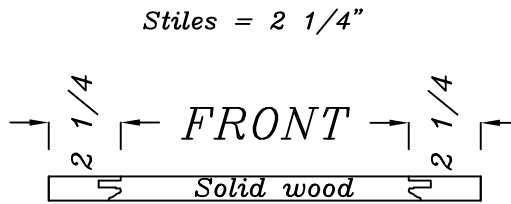
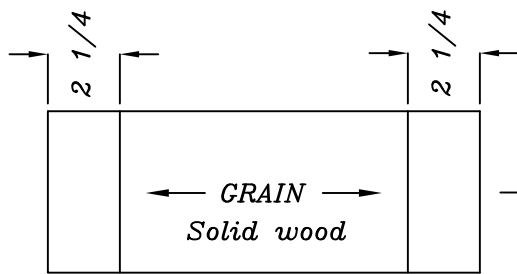

Minimum height available = 4"

3 piece front drawer corresponding doors edge profile

OPTIONS

? Edge profiles E-01 to E-58

1 PROFILES
2 TRADITIONAL 90
3 DISTINCTIVE 90
4 CATHEDRAL 90
5 APPLIED MOULDINGS
6 PRESTIGE 45
7 WAINSCOTS
8 SPECIALITY PRODUCTS
9 MOULDINGS
10 PROMOTIONAL ITEMS
11 POLICY

Front Options

Distinctive series

- 1 PROFILES
- 2 TRADITIONAL 90
- 3 DISTINCTIVE 90
- 4 CATHEDRAL 90
- 5 APPLIED MOULDINGS
- 6 PRESTIGE 45
- 7 WAINSCOTS
- 8 SPECIALTY PRODUCTS
- 9 MOULDINGS
- 10 PROMOTIONAL ITEMS
- 11 POLICY

SLAB: # 803/?

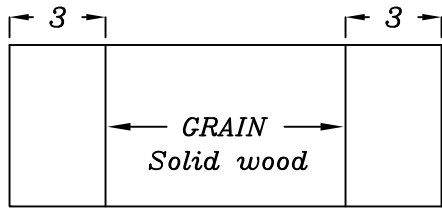

Stiles = 3"



Edge profile shown = E-01

Minimum height available = 4"

3 piece front drawer corresponding doors edge profile

OPTIONS

?	Edge profiles	E-01 to E-58
---	---------------	--------------

SLAB: # 11803/?

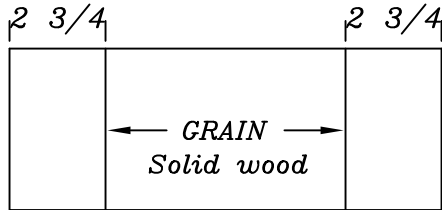

Stiles = 2 3/4"



Edge profile shown = E-01

Minimum height available = 4"

3 piece front drawer corresponding doors edge profile

OPTIONS

?	Edge profiles	E-01 to E-58
---	---------------	--------------

Frames

Distinctive series

Glass
dimensionWidth of glass

$$\textcircled{L} - (\textcircled{A} + \textcircled{B}) + 11/16 = \text{width of glass}$$

$$\text{EX: } 12 - (2 \frac{1}{4} + 2 \frac{1}{4}) + 11/16 = 8 \frac{3}{16}$$

Height of glass

$$\textcircled{H} - (\textcircled{C} + \textcircled{D}) + 11/16 = \text{height of glass}$$

$$\text{EX: } 24 - (2 \frac{1}{4} + 2 \frac{1}{4}) + 11/16 = 20 \frac{3}{16}$$

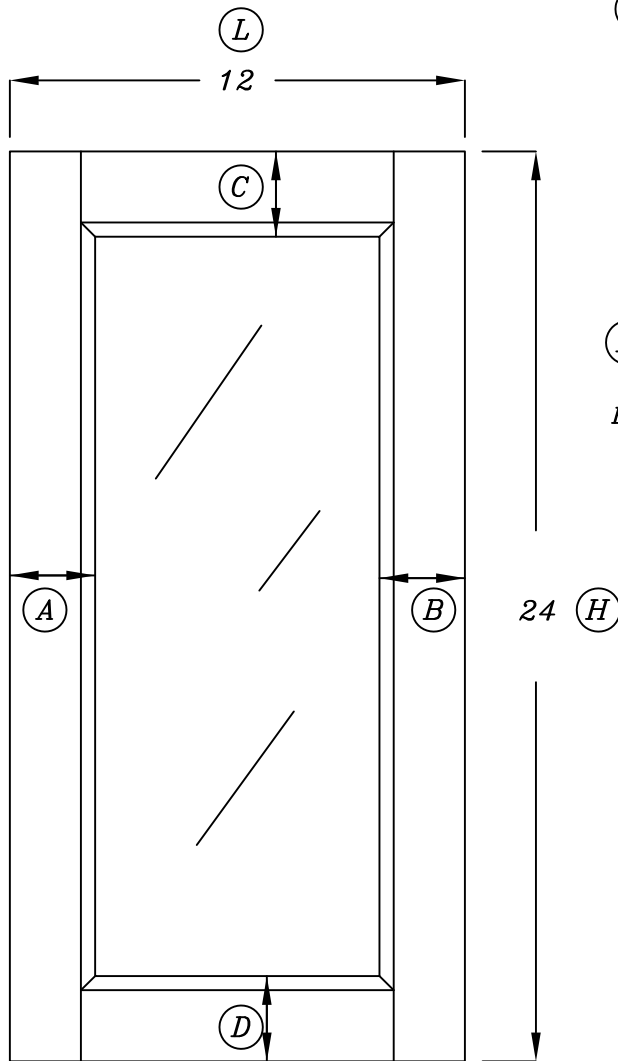

This calculation
leaves a tolerance
between
 $\frac{1}{16}$ '' and $\frac{1}{8}$ ''

Frame Options

Distinctive series

- 1 PROFILES
- 2 TRADITIONAL 90
- 3 DISTINCTIVE 90
- 4 CATHEDRAL 90
- 5 APPLIED MOULDINGS
- 6 PRESTIGE 45
- 7 WAINSCOTS
- 8 SPECIALTY PRODUCTS
- 9 MOULDINGS
- 10 PROMOTIONAL ITEMS
- 11 POLICY

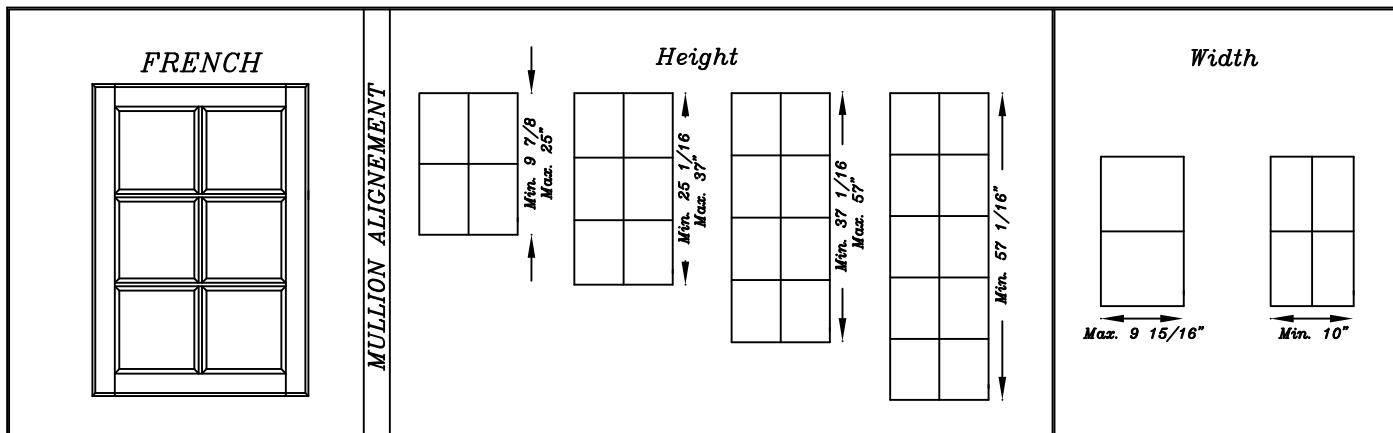

OPTIONS

?	Edge profiles	E-01 to E-58
?	Framing beads	A/B/C/D/E/F/G/H/J/K/L/M/N/O/P Q/R/S/T/U/V/W/X/Y/Z/2/3/4/5/7
?	Amount of tiles	0/2/3/4/6/8/9/10

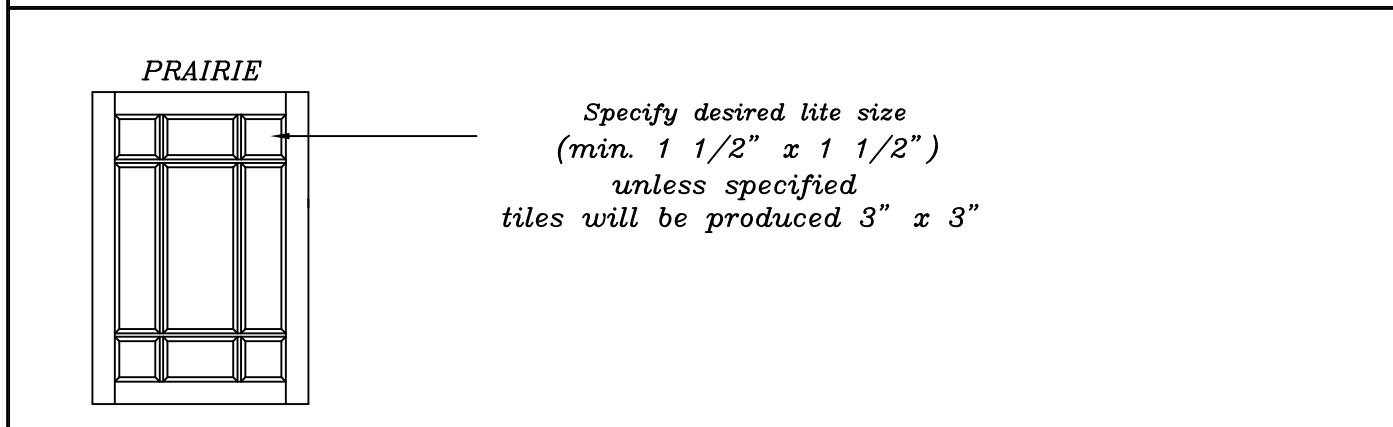

Frame Options

Distinctive series

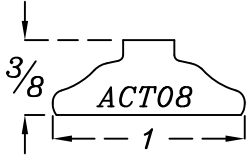
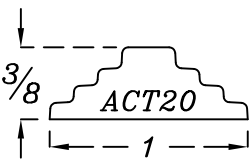
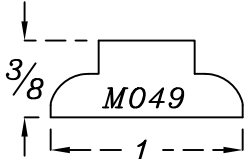
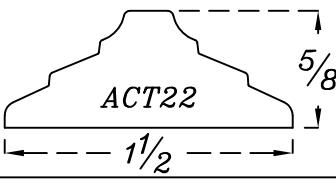
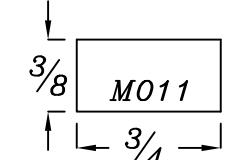
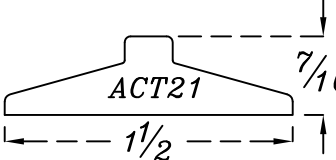
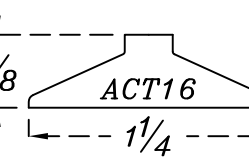
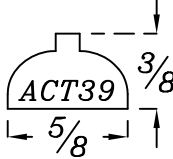
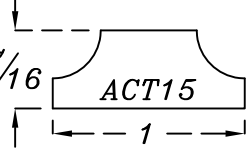
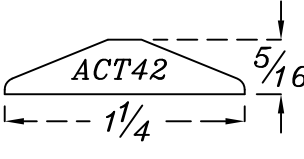
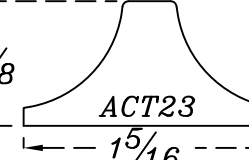
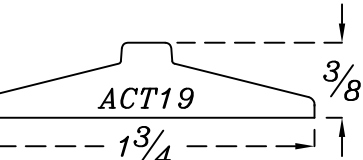
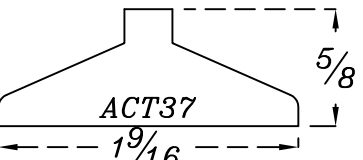
<i>Mullions models</i>	<i>Framing beads</i>	<i>Mullions models</i>	<i>Framing beads</i>
 <p>ACT08</p>	A/F/G/M/P/W	 <p>ACT20</p>	V
 <p>M049</p>	B	 <p>ACT22</p>	X
 <p>M011</p>	C/D/E/H/J/N/O Q/S/Y/3/4/5	 <p>ACT21</p>	Z
 <p>ACT16</p>	K	 <p>ACT39</p>	2
 <p>ACT15</p>	L	 <p>ACT42</p>	7
 <p>ACT23</p>	R		
 <p>ACT19</p>	T		
 <p>ACT37</p>	U		

Doors

Distinctive series

- 1 PROFILES
- 2 TRADITIONAL 90
- 3 DISTINCTIVE 90
- 4 CATHEDRAL 90
- 5 APPLIED MOULDINGS
- 6 PRESTIGE 45
- 7 WAINSCOTS
- 8 SPECIALTY PRODUCTS
- 9 MOULDINGS
- 10 PROMOTIONAL ITEMS
- 11 POLICY

DOOR # 40

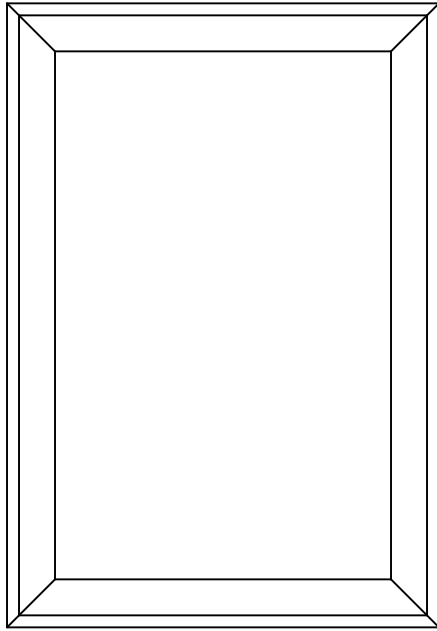

Minimum width and height 3"

FRAME # 505/?

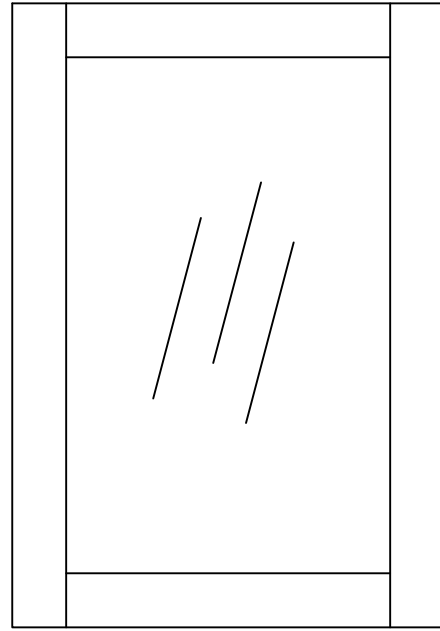

Minimum width and height = 5 5/8"

FRONT

*Edge profile
E-29 only*

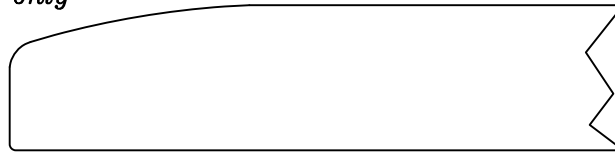

MDF door

MDF DRAWER FRONT # 41

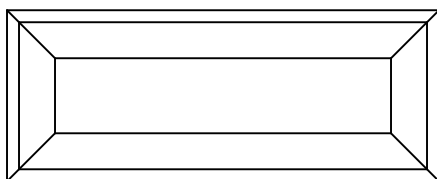

Minimum width and height 3"

Drawer front in MDF

*Edge profile
E-29 only*

Doors

Distinctive series

DOOR # 50/?

FRAME # 505/???

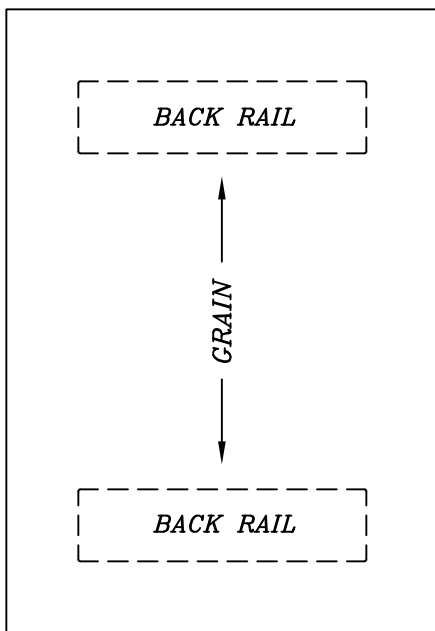

Minimum width and height 6"

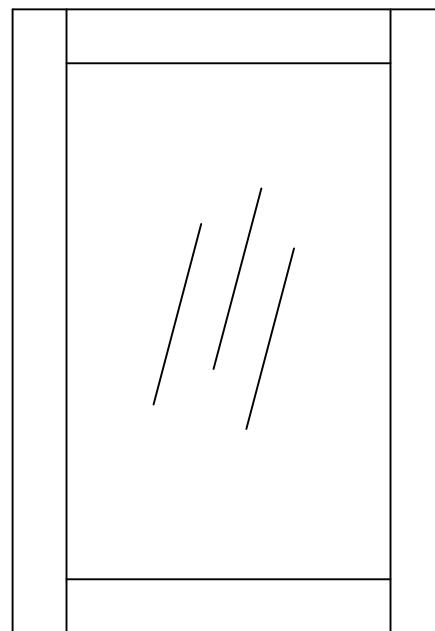

Minimum width and height = 5 5/8"

FRONT

Edge profile shown = E-01

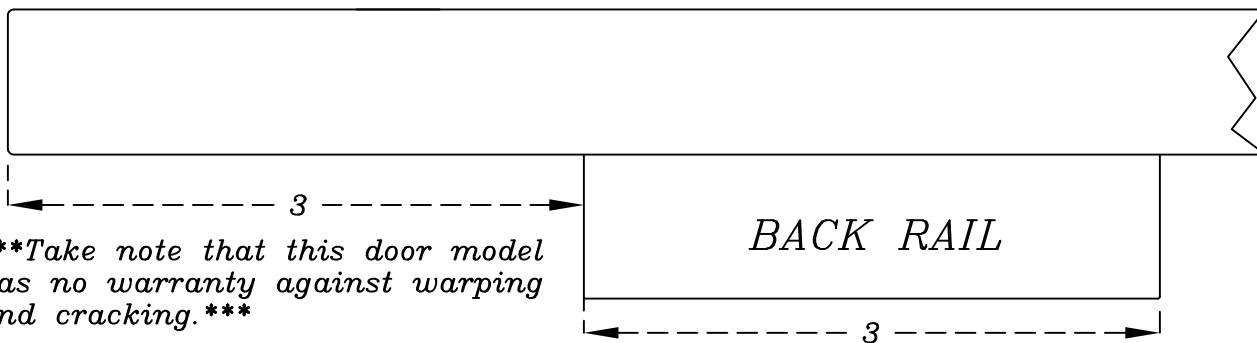

*****Take note that this door model has no warranty against warping and cracking.*****

Slab door with screwed and unglued back rail

DRAWER FRONT SLAB # 51/?

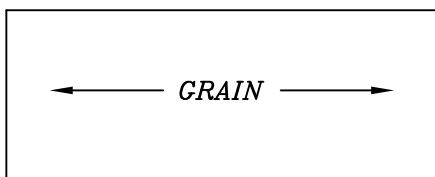

Matches edge profile

Doors

Distinctive series

DOOR # 400/???

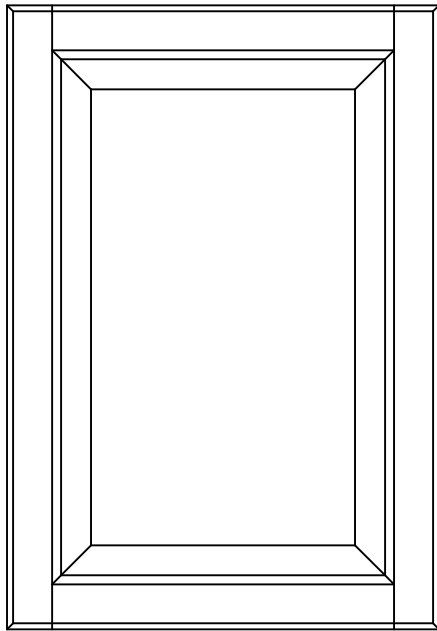

Minimum width (solid) = 9 1/4"
 Minimum height (solid) = 8 1/4"
 Minimum width (veneer) = 7 7/8"
 Minimum height (veneer) = 6 7/8"

FRAME # 405/???

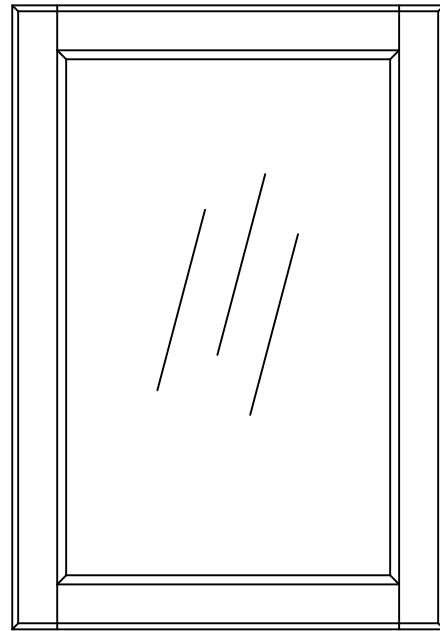

Minimum width = 7 7/8"
 Minimum height = 6 7/8"

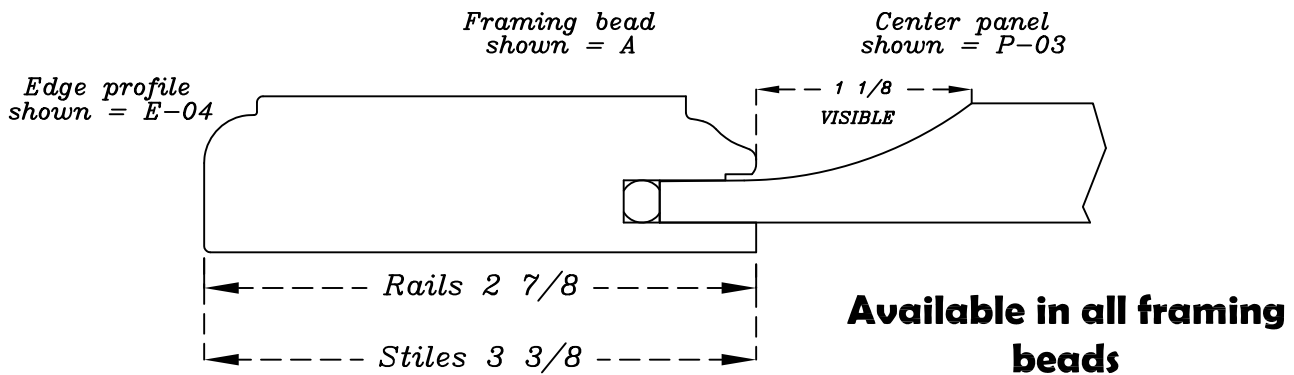

5-PIECE DRAWER FRONT: # 401/???

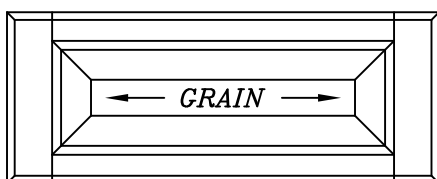

Minimum height available = 7 1/2"
 Minimum width available = 9 1/2"
 (With 1 1/8 visible panel)

Stiles = 3 3/8"
 Rails = 2 3/8"

5-piece drawer front matches edge profile, framing bead and center panel profile

- 1 PROFILES
- 2 TRADITIONAL 90
- 3 DISTINCTIVE 90
- 4 CATHEDRAL 90
- 5 APPLIED MOULDINGS
- 6 PRESTIGE 45
- 7 WANSCOOTS
- 8 SPECIALTY PRODUCTS
- 9 MOULDINGS
- 10 PROMOTIONAL ITEMS
- 11 POLICY

DOOR # 10100/???

FRAME # 10105/???

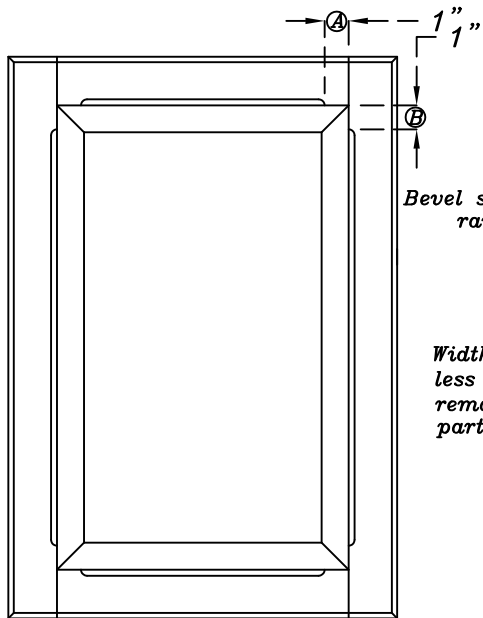

Bevel stops at 1" of the rails and stiles

Width and height of less than 8" bevel remains 1" but the parts A and B will be reduced

Minimum width and height (solid) = 7 1/2"
Minimum width and height (veneer) = 6 1/2"

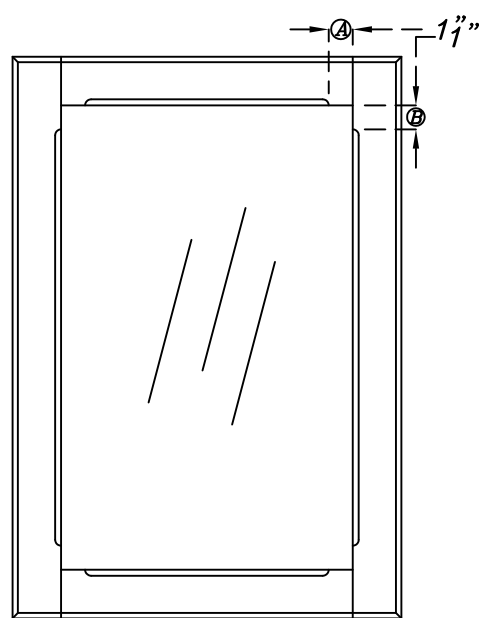

Minimum width and height = 6 1/2"

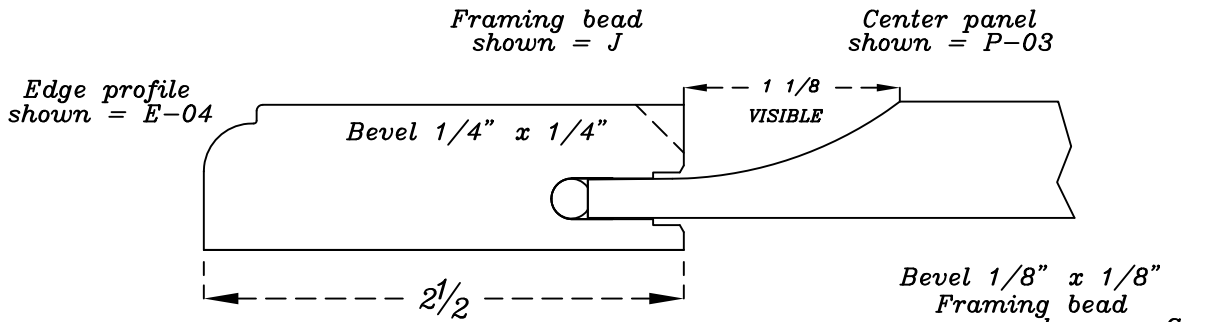

Available in framing beads C and J only

5-PIECE DRAWER FRONT: # 10101/???

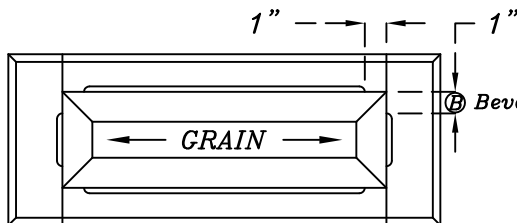

Bevel stops at 1" of the rails and stiles

Stiles = 2 1/2"
Rails = 1 1/2"

Height of less than 6" bevel remains 1" but the part B will be reduced

Minimum height available = 5 3/4"
Minimum width available = 7 3/4"
(With 1 1/8 visible panel)

5-piece drawer front matches edge profile, framing bead and center panel profile

Doors

Distinctive series

- 1 PROFILES
- 2 TRADITIONAL 90
- 3 DISTINCTIVE 90
- 4 CATHEDRAL 90
- 5 APPLIED MOULDINGS
- 6 PRESTIGE 45
- 7 WANSCOTS
- 8 SPECIALTY PRODUCTS
- 9 MOULDINGS
- 10 PROMOTIONAL ITEMS
- 11 POLICY

DOOR # 10200/???

FRAME # 10205/???

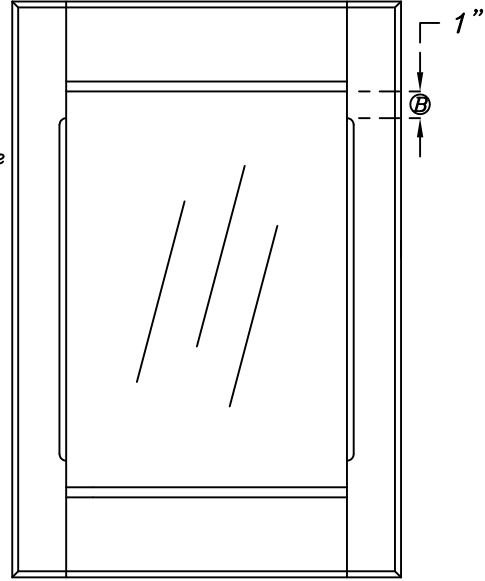
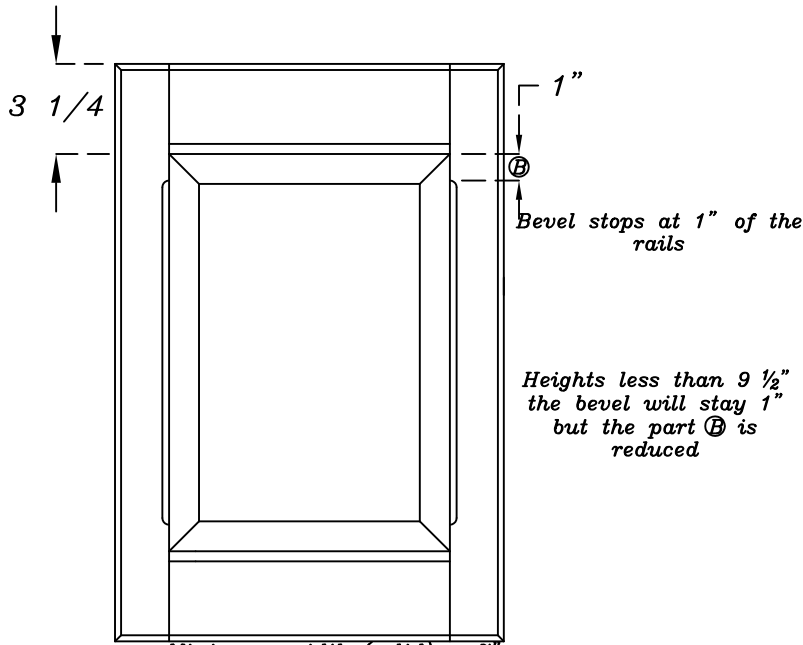

Minimum width (solid) = 7"
 Minimum height (solid) = 9"
 Minimum width (veneer) = 5 5/8"
 Minimum height (veneer) = 8"

Minimum width = 5 5/8"
 Minimum height = 8"

Heights less than 9 1/2"
 the bevel will stay 1"
 but the part B is reduced

Framing bead shown = J

Center panel shown = P-03

Edge profile shown = E-04

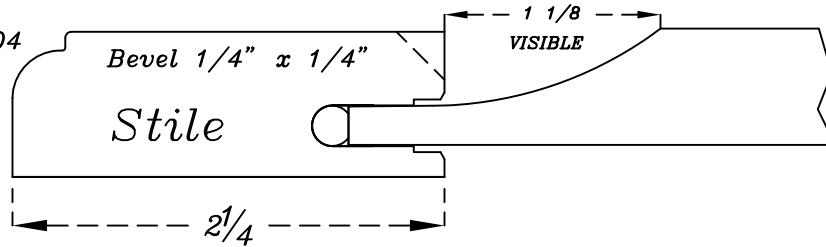

Stile only available in J framing bead

Rails available in all framing beads except : C,D,E,H,O,R,S,X,Y,U,4,7

5-PIECE DRAWER FRONT: # 10201/???

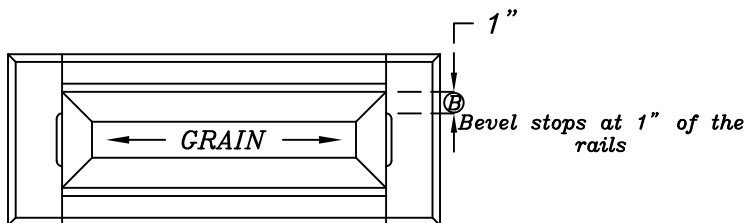

Stiles = 2 1/4"
 Rails = 1 9/16"

Heights less than 6 1/8" the bevel will stay at 1" but the part B is reduced

Minimum height available = 5 7/8"
 Minimum width available = 7 1/4"
 (With 1 1/8 visible panel)

5-piece drawer front matches edge profile, framing bead and center panel profile

Doors

Distinctive series

DOOR # 10500/??

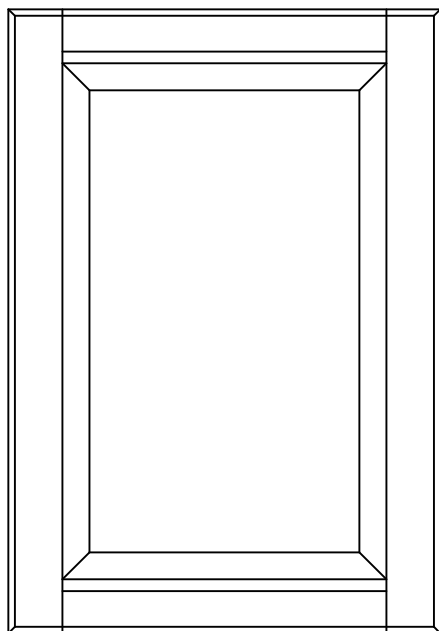

Minimum width and height (solid) = 7"
Minimum width and height (veneer) = 5 5/8"

FRAME # 10505/??

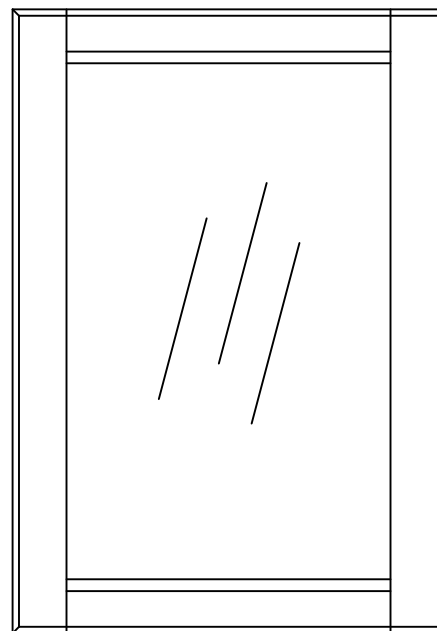

Minimum width and height = 5 5/8"

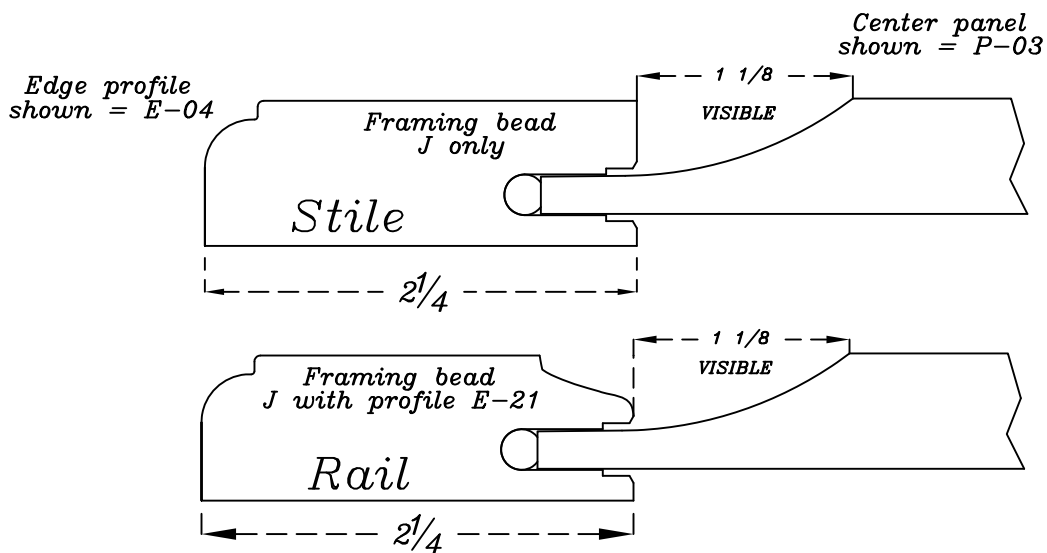

5-PIECE DRAWER FRONT: # 10501/??

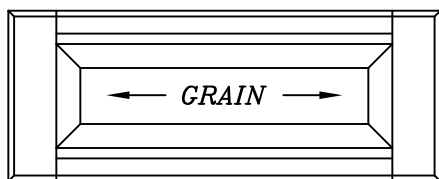

Minimum height available = 5 3/4"
Minimum width available = 7 1/4"
(With 1 1/8 visible panel)

Stiles = 2 1/4"
Rails = 1 1/2"

5-piece drawer front matches edge profile, framing bead and center panel profile

Doors

Distinctive series

- 1 PROFILES
- 2 TRADITIONAL 90
- 3 DISTINCTIVE 90
- 4 CATHEDRAL 90
- 5 APPLIED MOULDINGS
- 6 PRESTIGE 45
- 7 WANNSCOTS
- 8 SPECIALTY PRODUCTS
- 9 MOULDINGS
- 10 PROMOTIONAL ITEMS
- 11 POLICY

DOOR # 10600/??

FRAME # 10605/??

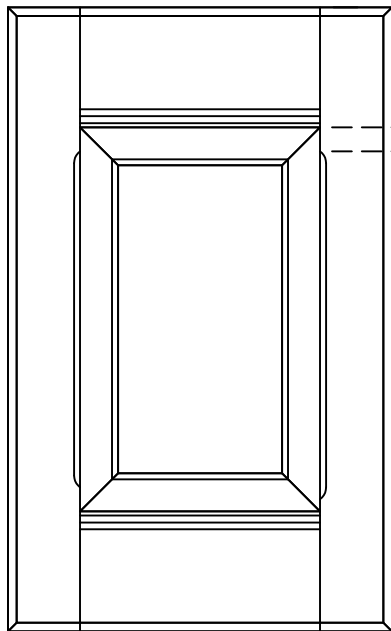

Bevel stops at $\frac{3}{4}$ " of the rails

Heights less than $9\frac{1}{2}$ " bevel will remain 1" but the part B will be reduced

Minimum width (solid) = 7"
 Minimum height (solid) = 10"
 Minimum width (veneer) = $5\frac{5}{8}$ "
 Minimum height (veneer) = 9"

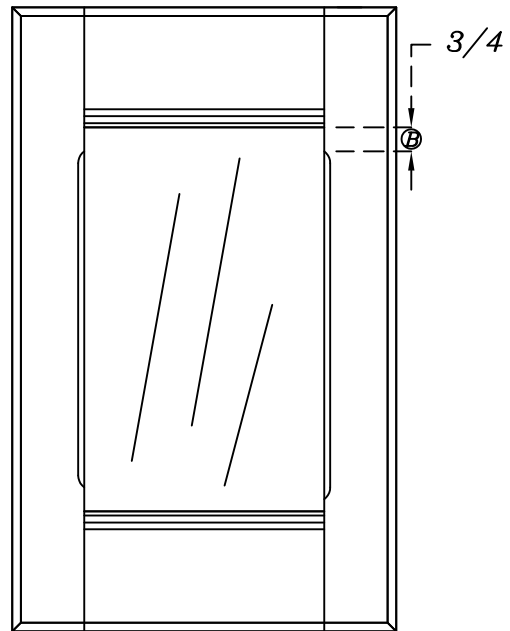

Minimum width = $5\frac{5}{8}$ "
 Minimum height = 9"

Center panel shown = P-03

Edge profile shown = E-04

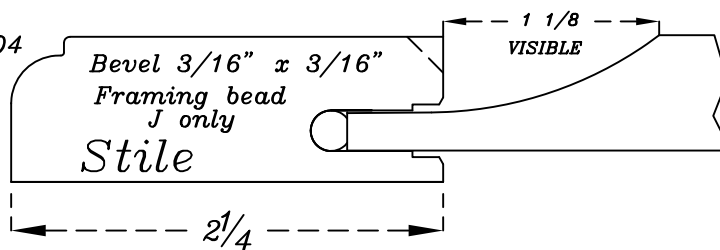

Bevel $\frac{3}{16}$ " x $\frac{3}{16}$ "
 Framing bead J only

Stile

$2\frac{1}{4}$

$1\frac{1}{8}$ VISIBLE

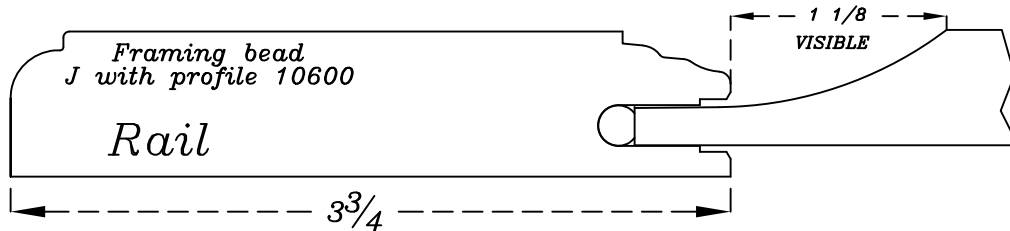

Framing bead J with profile 10600

Rail

$3\frac{3}{4}$

$1\frac{1}{8}$ VISIBLE

5-PIECE DRAWER FRONT: # 10601/??

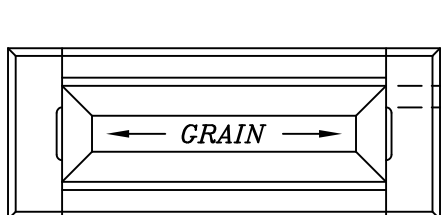

Bevel stops at $\frac{3}{4}$ " of the rails

Stiles = $2\frac{1}{4}$ "
 Rails = $1\frac{9}{16}$ "

Heights less than $5\frac{5}{8}$ " bevel will remain 1" but the part B will be reduced

Minimum height available = $5\frac{7}{8}$ "
 Minimum width available = $7\frac{1}{4}$ "
 (With $1\frac{1}{8}$ visible panel)

5-piece drawer front matches edge profile, framing bead and center panel profile

Doors

Distinctive series

DOOR # 10800/???

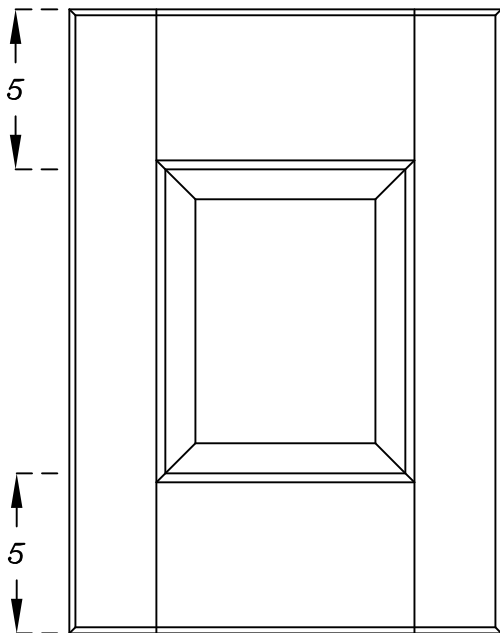

Minimum width (solid) = 8 1/2"
Minimum height (solid) = 12 1/2"
Minimum width (veneer) = 7 1/8"
Minimum height (veneer) = 11 1/8"

FRAME # 10805/???

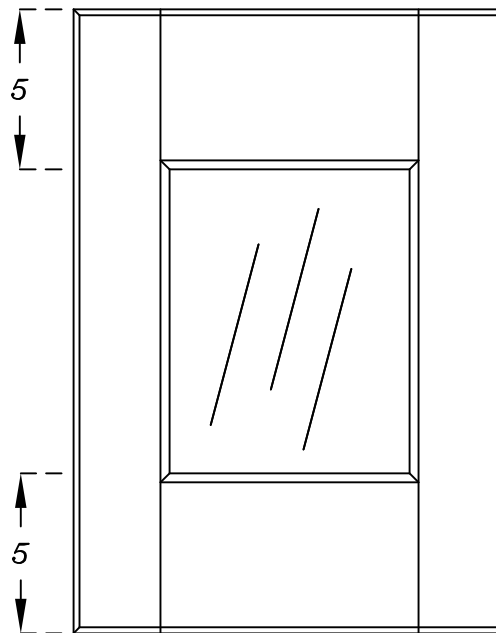

Minimum width = 7 1/8"
Minimum height = 11 1/8"

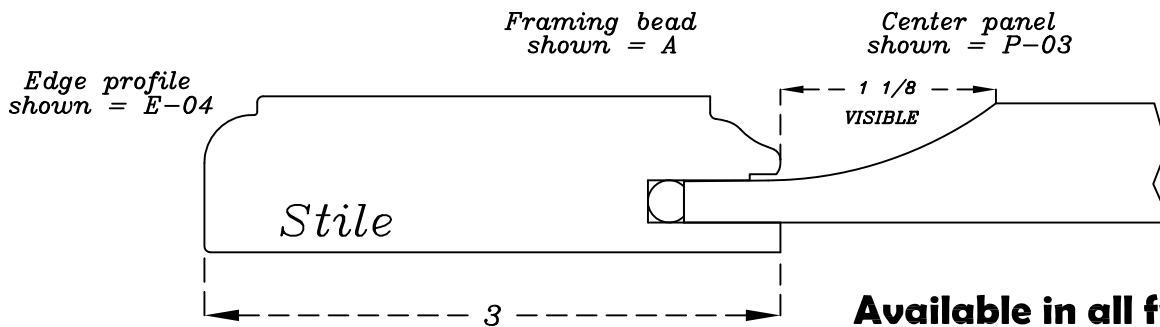

Available in all framing beads

5-PIECE DRAWER FRONT: # 10801/???

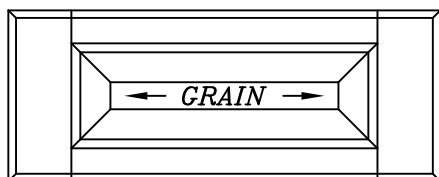

Minimum height available = 6 1/4"
Minimum width available = 8 3/4"
(With 1 1/8 visible panel)

Stiles = 3"
Rails = 1 3/4"

5-piece drawer front matches edge profile, framing bead and center panel profile

Doors

Distinctive series

- 1 PROFILES
- 2 TRADITIONAL 90
- 3 DISTINCTIVE 90
- 4 CATHEDRAL 90
- 5 APPLIED MOULDINGS
- 6 PRESTIGE 45
- 7 WANNSCOTS
- 8 SPECIALTY PRODUCTS
- 9 MOULDINGS
- 10 PROMOTIONAL ITEMS
- 11 POLICY

DOOR # 11200/??

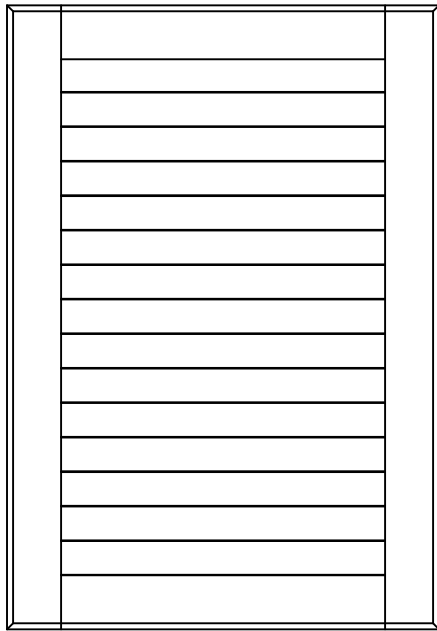

Minimum width and height = 5 5/8"

FRAME # 11205/??

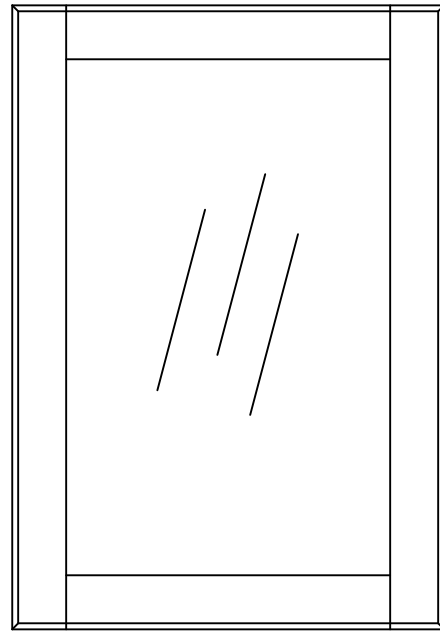

Minimum width and height = 5 5/8"

Edge profile shown = E-04

Framing bead shown = J

Panneau V-43 only

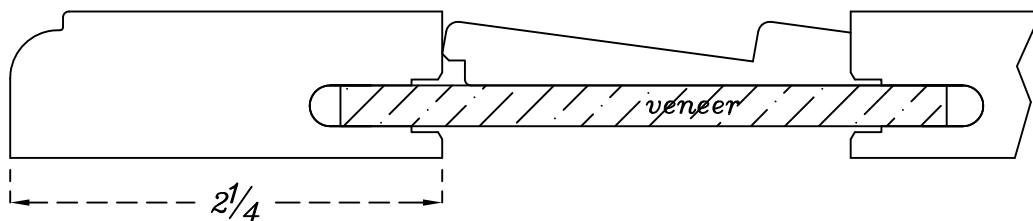

Stiles and Rails only available in J and N framing bead

5-PIECE DRAWER FRONT: # 11201/??

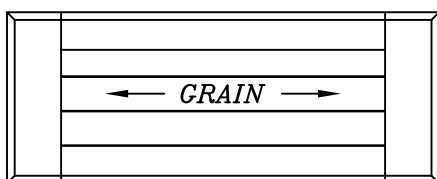

Minimum height available = 5 1/2"
Minimum width available = 5 5/8"

Stiles = 2 1/4"
Rails = 1 9/16"

5-piece drawer front matches edge profile, framing bead and center panel profile

DOOR # 11400/???

FRAME # 11405/???

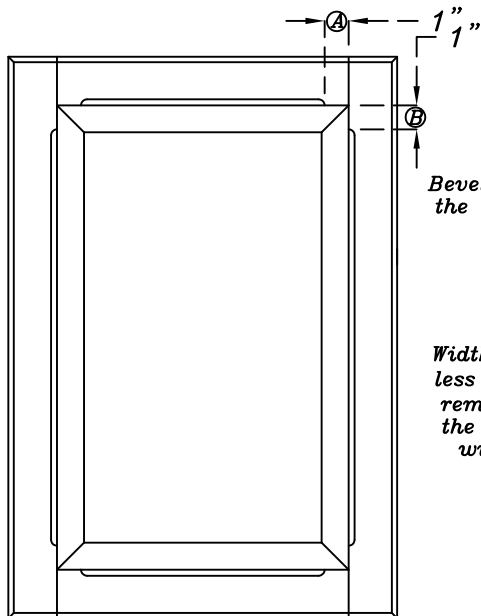

Bevel stops at 1" of the rails and stiles

Width and height of less than 8" bevel remains at 1" but the parts A and B will be reduced

Minimum width and height (solid) = 7"
Minimum width and height (veneer) = 6"

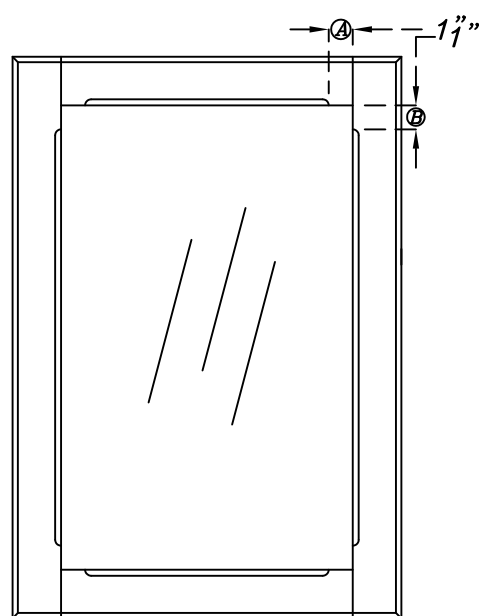

Minimum width and height = 6"

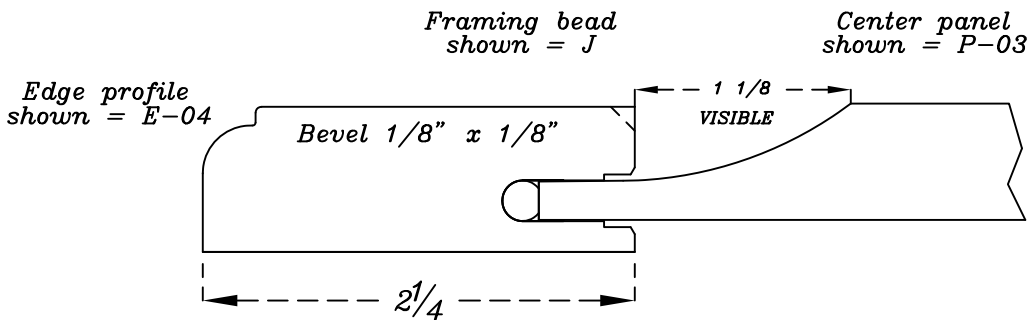

Stiles and Rails only available in framing beads C and J

5-PIECE DRAWER FRONT: # /???

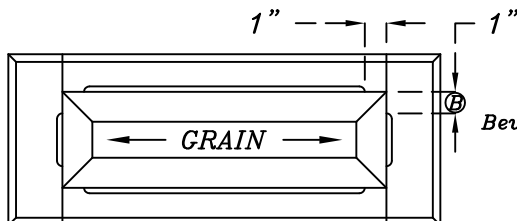

Bevel stops at 1" of Rails

Stiles = 2 1/4"
Rails = 1 9/16"

Height of less than 6" bevels will stay at 1" but the part B will be reduced

Minimum height available = 5 7/8"
Minimum width available = 7 1/4"
(With 1 1/8 visible panel)

5-piece drawer front matches edge profile, framing bead and center panel profile

Doors

Distinctive series

- 1 PROFILES
- 2 TRADITIONAL 90
- 3 DISTINCTIVE 90
- 4 CATHEDRAL 90
- 5 APPLIED MOULDINGS
- 6 PRESTIGE 45
- 7 WAINSCOTS
- 8 SPECIALTY PRODUCTS
- 9 MOULDINGS
- 10 PROMOTIONAL ITEMS
- 11 POLICY

DOOR # 11500/??

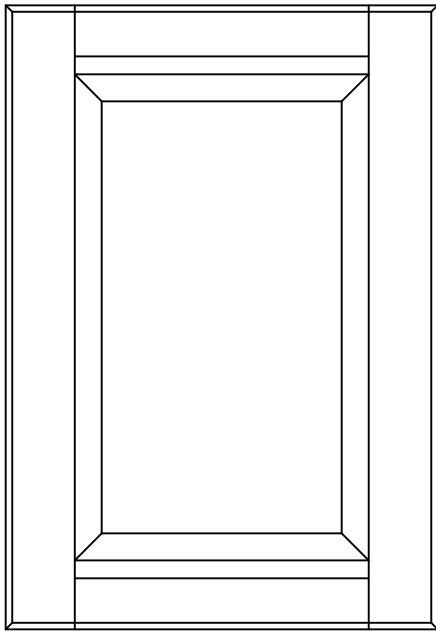

Minimum width and height (solid) = 8 1/4"
 Minimum width and height (veneer) = 7 1/4"

FRAME # 11505/??

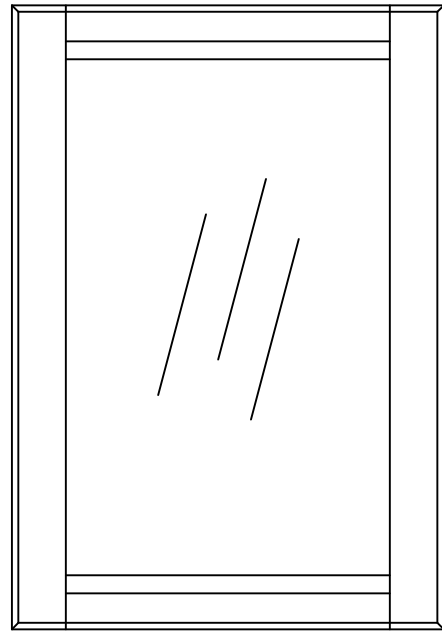

Minimum width and height = 7 1/4"

Edge profile shown = E-04

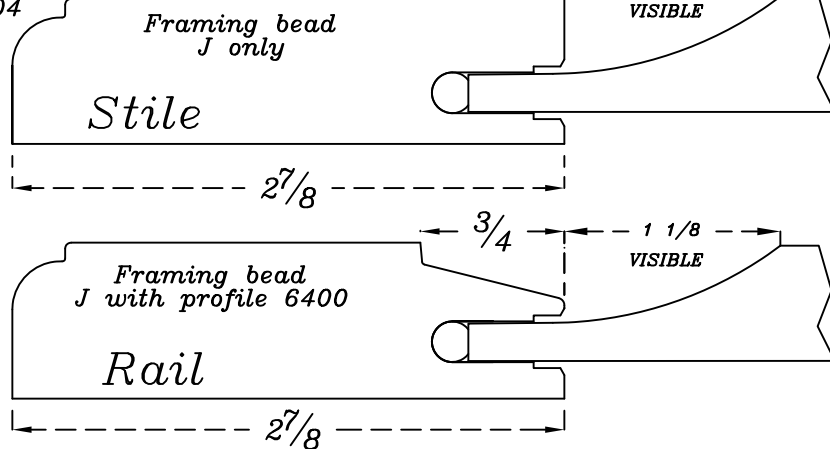

5-PIECE DRAWER FRONT: # 11501/??

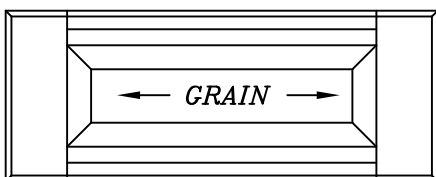

Minimum height available = 6"
 Minimum width available = 8 1/2"
 (With 1 1/8 visible panel)

Stiles = 2 7/8"
 Rails = 1 5/8"

5-piece drawer front matches edge profile, framing bead and center panel profile

Doors

Distinctive series

DOOR # 11700/???

FRAME # 11705/???

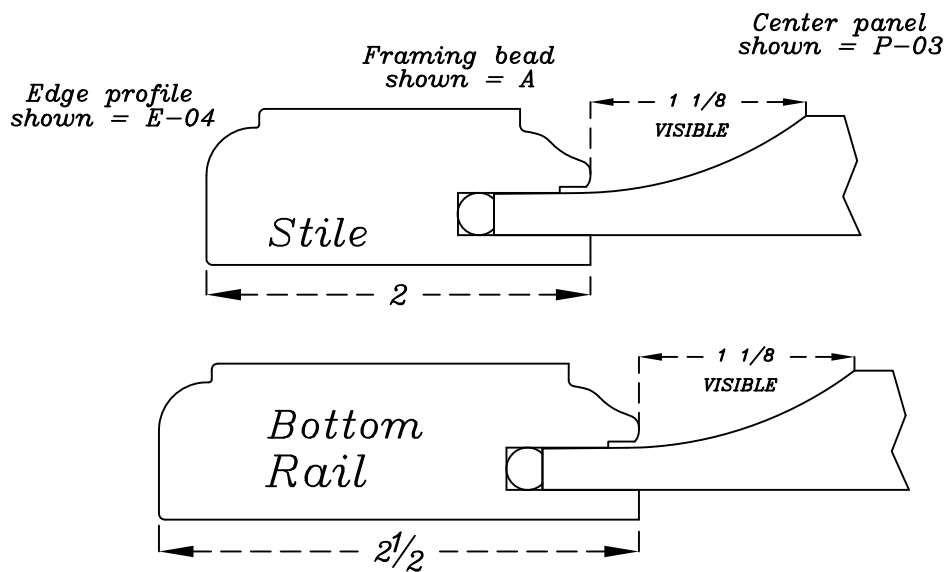
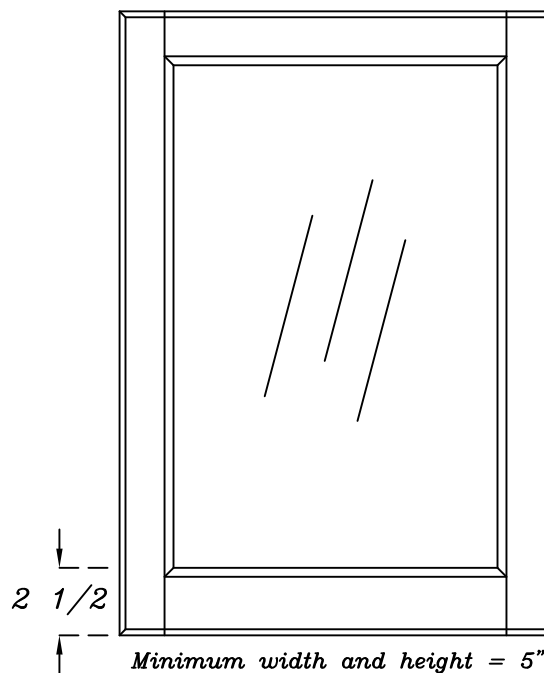
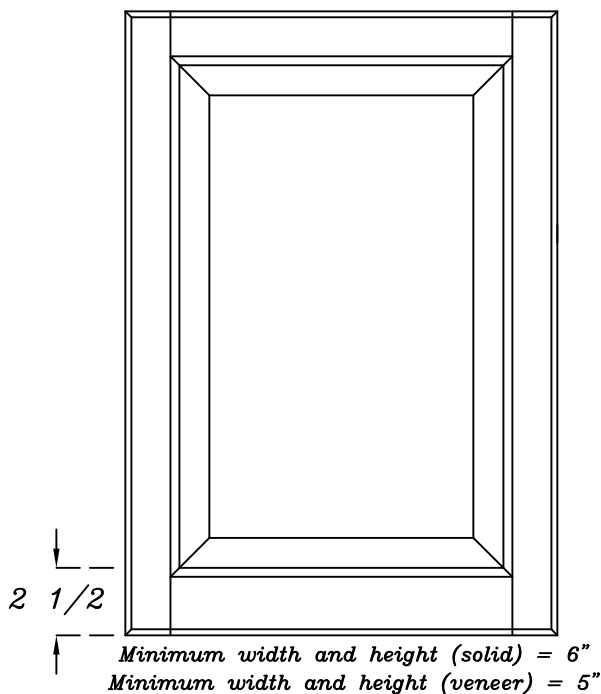

5-PIECE DRAWER FRONT: # 11701/???

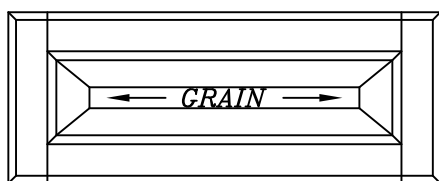

Stiles = 2"
Rails = 2"

5-piece drawer front matches edge profile, framing bead and center panel profile

Minimum height available = 6 3/4"
Minimum width available = 6 3/4"
(With 1 1/8 visible panel)

Doors

Distinctive series

- 1 PROFILES
- 2 TRADITIONAL 90
- 3 DISTINCTIVE 90
- 4 CATHEDRAL 90
- 5 APPLIED MOULDINGS
- 6 PRESTIGE 45
- 7 WANNSCOTS
- 8 SPECIALTY PRODUCTS
- 9 MOULDINGS
- 10 PROMOTIONAL ITEMS
- 11 POLICY

DOOR # 12200/??

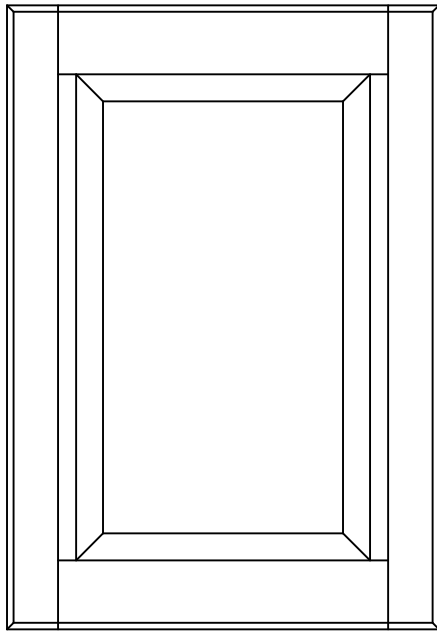

Minimum width and height (solid) = 7"
Minimum width and height (veneer) = 6"

FRAME # 12205/??

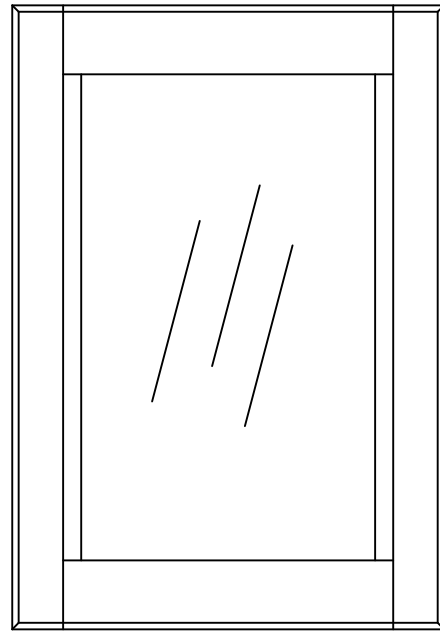

Minimum width and height = 6"

Center panel shown = P-03

Edge profile shown = E-04

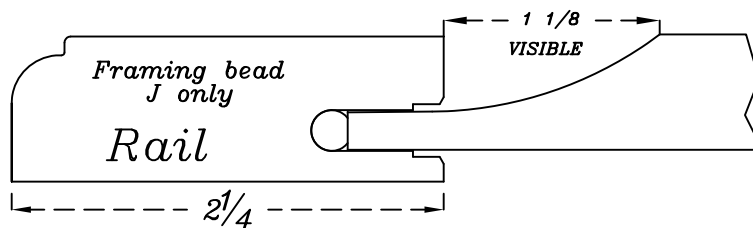
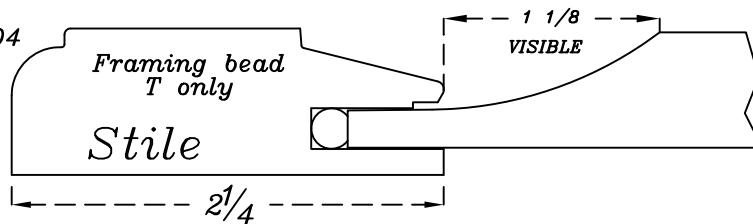

5-PIECE DRAWER FRONT: # 12201/??

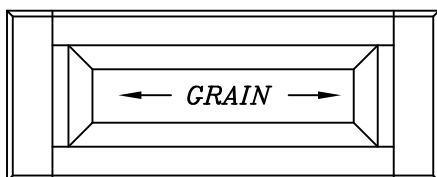

Minimum height available = 5 3/4"
Minimum width available = 7 1/4"
(With 1 1/8 visible panel)

Stiles = 2 1/4"
Rails = 1 1/2"

5-piece drawer front matches edge profile, framing bead and center panel profile

Doors

Distinctive series

DOOR # 12300/??

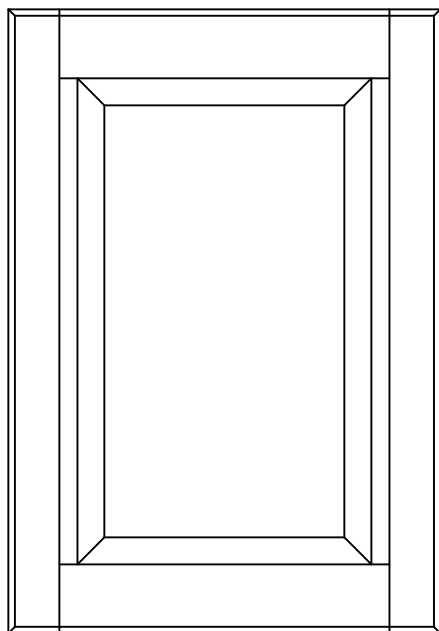

Minimum width and height (solid) = 8 1/2"
Minimum width and height (veneer) = 7 1/2"

FRAME # 12305/??

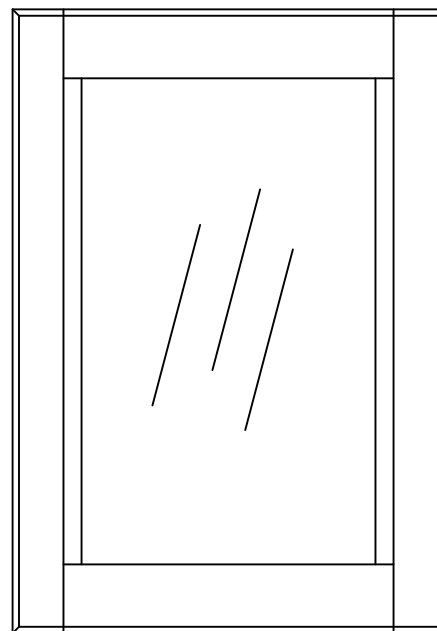

Minimum width and height = 7 1/2"

Center panel shown = P-03

Edge profile shown = E-04

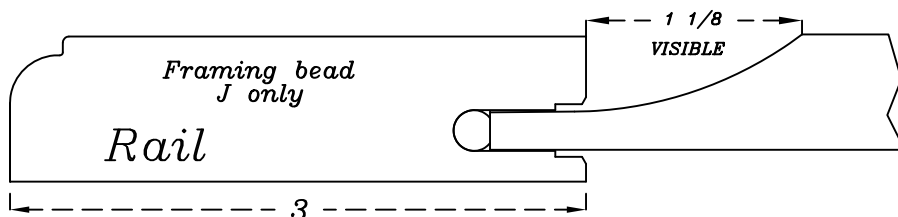
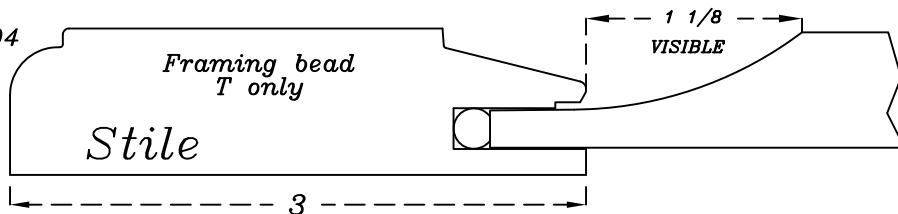

5-PIECE DRAWER FRONT: # 12301/??

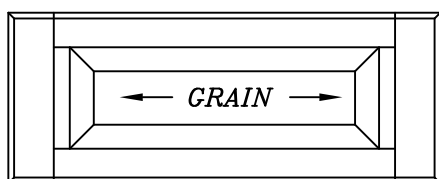

Minimum height available = 5 3/4"
Minimum width available = 8 3/4"
(With 1 1/8 visible panel)

Stiles = 3"
Rails = 1 1/2"

5-piece drawer front matches edge profile, framing bead and center panel profile

Doors

Distinctive series

- 1 PROFILES
- 2 TRADITIONAL 90
- 3 DISTINCTIVE 90
- 4 CATHEDRAL 90
- 5 APPLIED MOULDINGS
- 6 PRESTIGE 45
- 7 WANNSCOTS
- 8 SPECIALTY PRODUCTS
- 9 MOULDINGS
- 10 PROMOTIONAL ITEMS
- 11 POLICY

DOOR # 12400/??

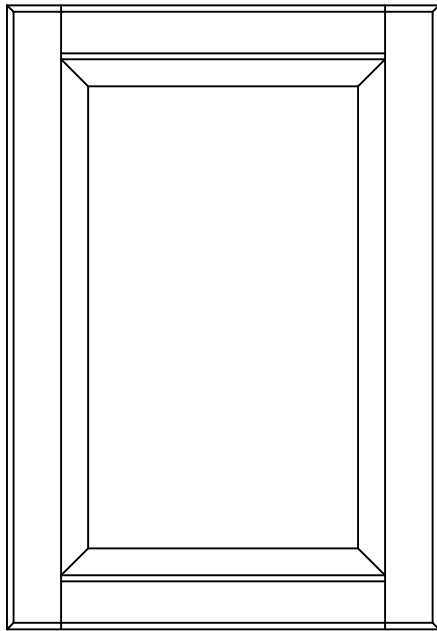

Minimum width and height (solid) = 7"
Minimum width and height (veneer) = 6"

FRAME # 12405/??

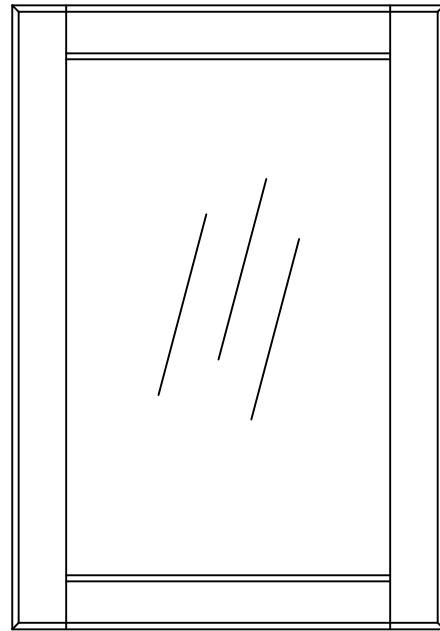

Minimum width and height = 6"

Edge profile shown = E-04

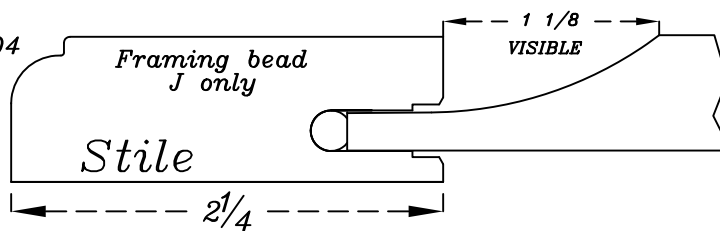

Center panel shown = P-03

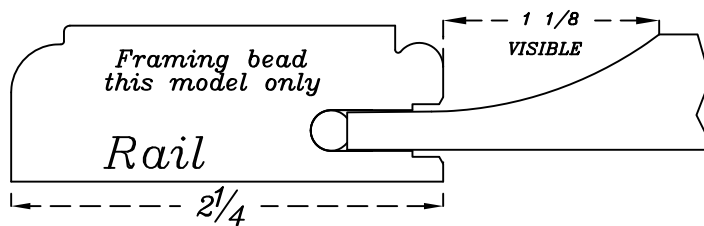

5-PIECE DRAWER FRONT: # 12401/??

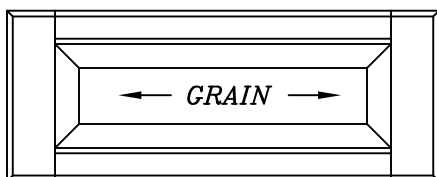

Minimum height available = 5 7/8"
Minimum width available = 7"
(With 1 1/8 visible panel)

Stiles = 2 1/4"
Rails = 1 9/16"

5-piece drawer front matches edge profile, framing bead and center panel profile

Doors

Distinctive series

DOOR # 12500/??

FRAME # 12505/??

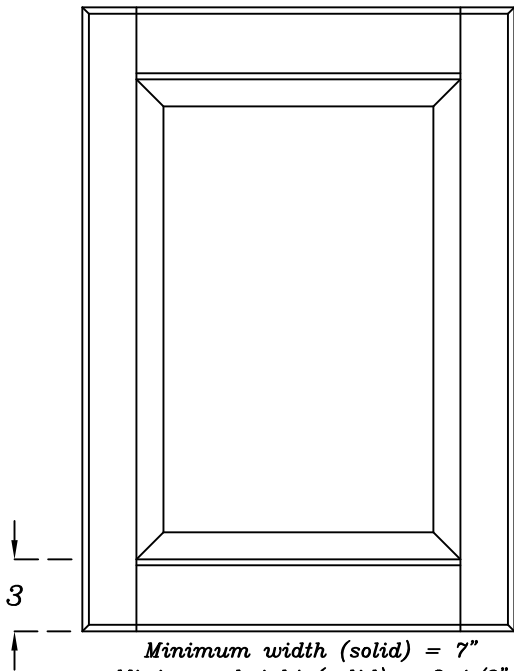

Minimum width (solid) = 7"
 Minimum height (solid) = 8 1/2"
 Minimum width (veneer) = 6"
 Minimum height (veneer) = 7 1/2"

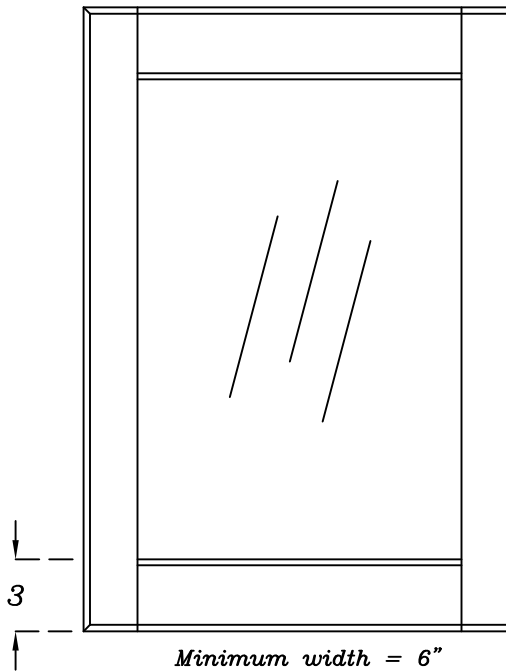

Minimum width = 6"
 Minimum height = 7 1/2"

Center panel shown = P-03

Edge profile shown = E-04

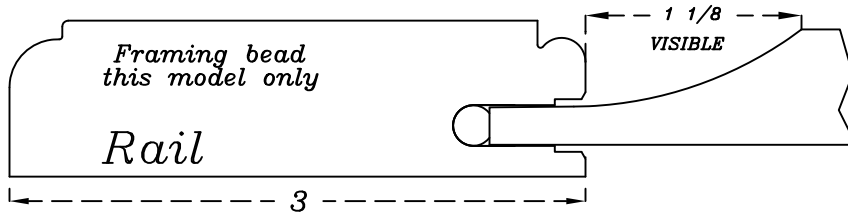
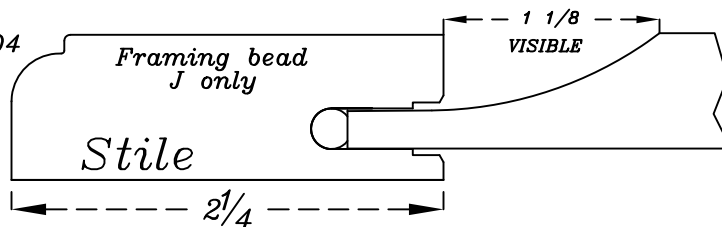

5-PIECE DRAWER FRONT: # 12501/??

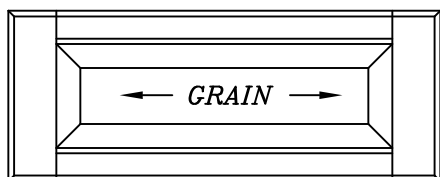

Minimum height available = 5 7/8"
 Minimum width available = 7"
 (With 1 1/8 visible panel)

Stiles = 2 1/4"
 Rails = 1 9/16"

5-piece drawer front matches edge profile, framing bead and center panel profile

Doors

Distinctive series

- 1 PROFILES
- 2 TRADITIONAL 90
- 3 DISTINCTIVE 90
- 4 CATHEDRAL 90
- 5 APPLIED MOULDINGS
- 6 PRESTIGE 45
- 7 WAINSCOTS
- 8 SPECIALTY PRODUCTS
- 9 MOULDINGS
- 10 PROMOTIONAL ITEMS
- 11 POLICY

DOOR # 12600/??

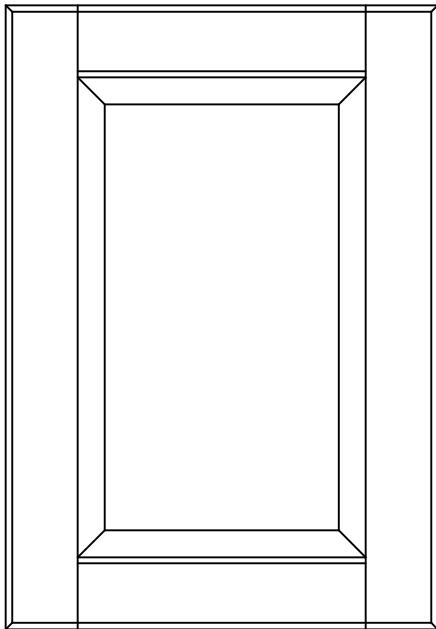

Minimum width and height (solid) = 8 1/2"
Minimum width and height (veneer) = 7 1/2"

FRAME # 12605/??

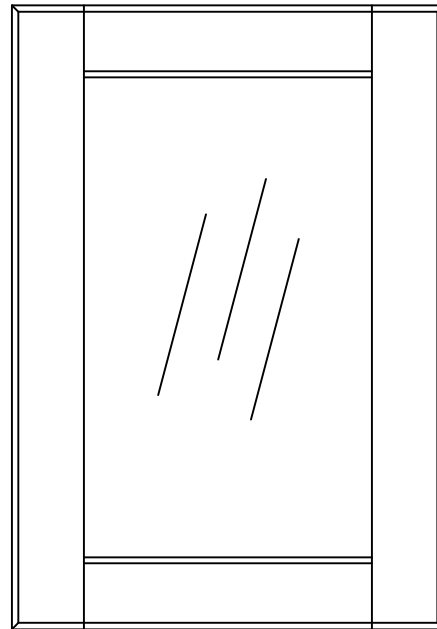

Minimum width and height = 7 1/2"

Edge profile shown = E-04

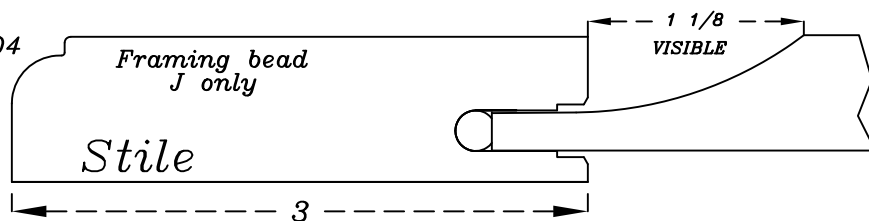

Center panel shown = P-03

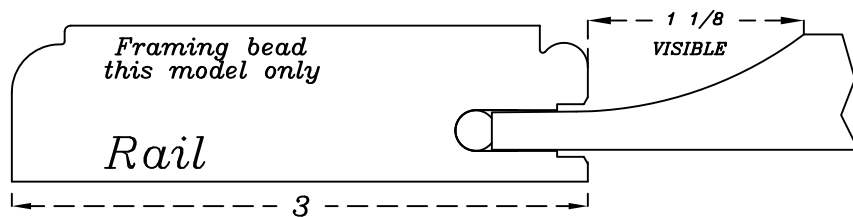

5-PIECE DRAWER FRONT: # 12601/??

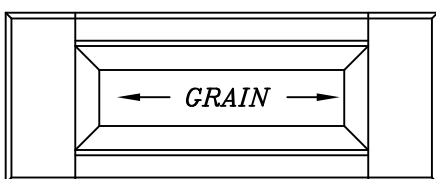

Minimum height available = 5 7/8"
Minimum width available = 7"
(With 1 1/8 visible panel)

Stiles = 3"
Rails = 1 9/16"

5-piece drawer front matches edge profile, framing bead and center panel profile

Doors

Distinctive series

DOOR # 12800/??

FRAME # 12805/??

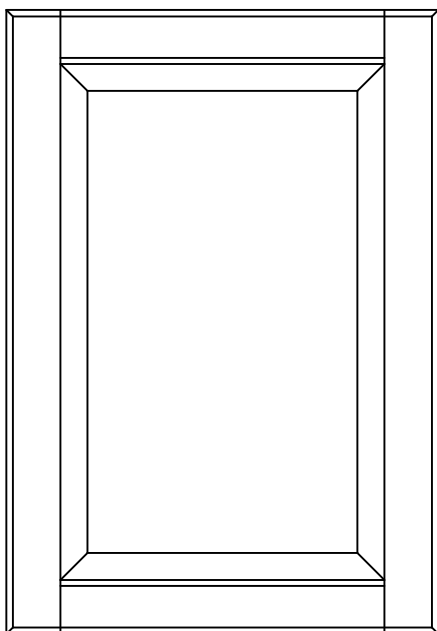

Minimum width and height (solid) = 7"
Minimum width and height (veneer) = 6"

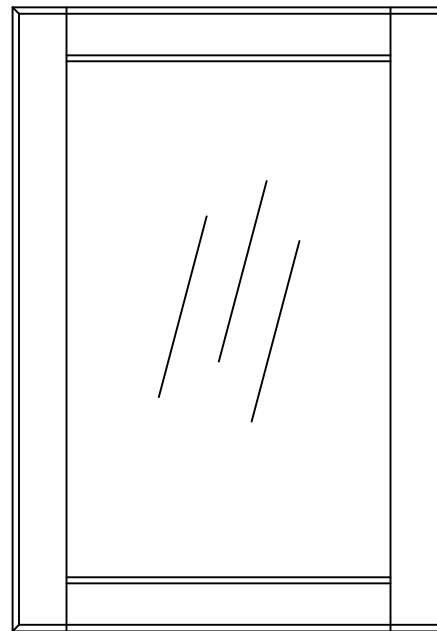

Minimum width and height = 6"

Edge profile shown = E-04

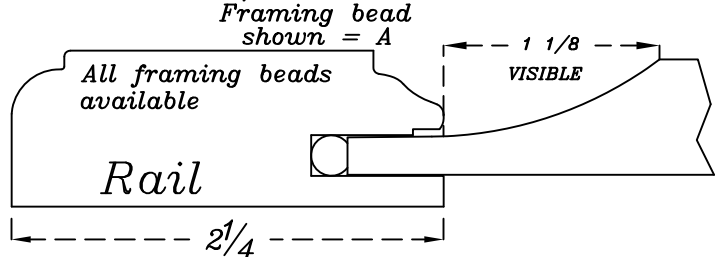
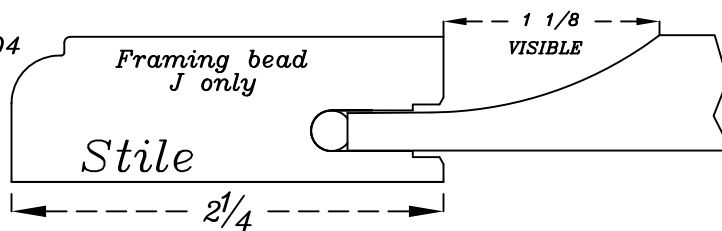

Center panel shown = P-03

5-PIECE DRAWER FRONT: # 12801/??

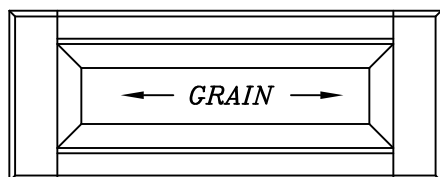

Minimum height available = 5 7/8"
Minimum width available = 7"
(With 1 1/8 visible panel)

Stiles = 2 1/4"
Rails = 1 9/16"

5-piece drawer front matches edge profile, framing bead and center panel profile

Doors

Distinctive series

- 1 PROFILES
- 2 TRADITIONAL 90
- 3 DISTINCTIVE 90
- 4 CATHEDRAL 90
- 5 APPLIED MOULDINGS
- 6 PRESTIGE 45
- 7 WAINSCOTS
- 8 SPECIALTY PRODUCTS
- 9 MOULDINGS
- 10 PROMOTIONAL ITEMS
- 11 POLICY

DOOR # 13000/??

FRAME # 13005/??

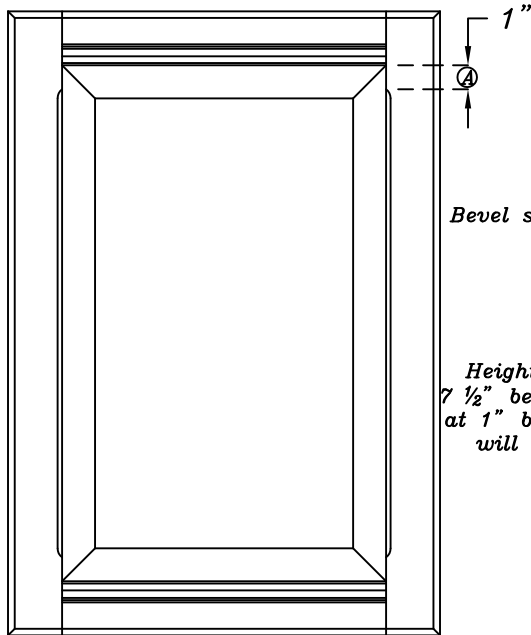

Bevel stops at 1" of Rails

Heights less than 7 1/2" bevels will stay at 1" but the part (A) will be reduced

Minimum width and height (solid) = 7"
Minimum width and height (veneer) = 6"

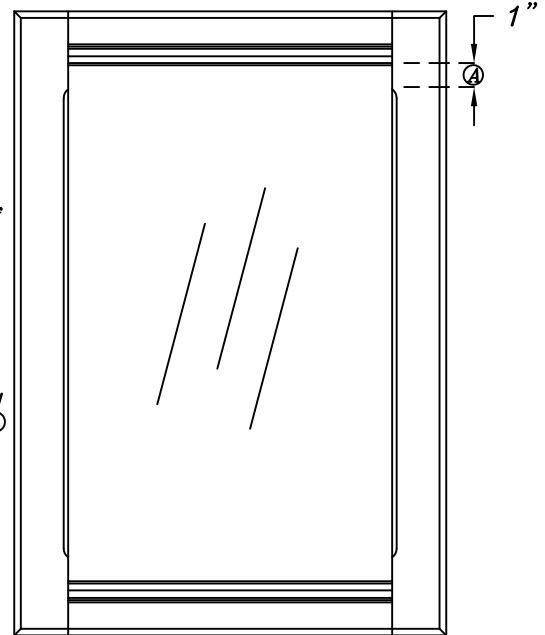

Minimum width and height = 6"

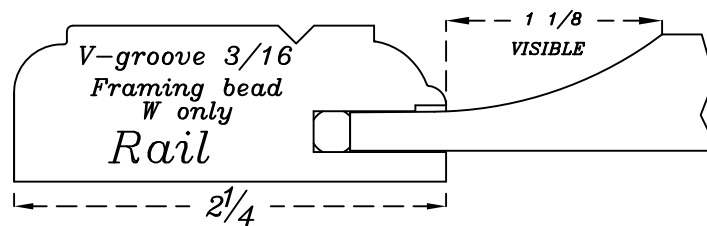
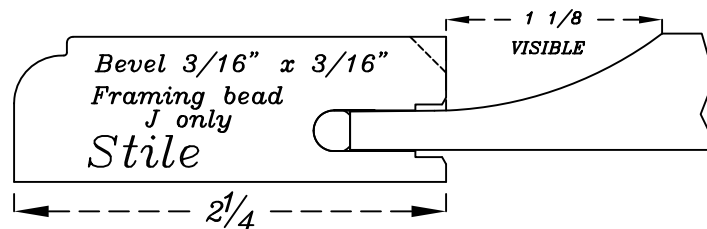

5-PIECE DRAWER FRONT: # 13001/??

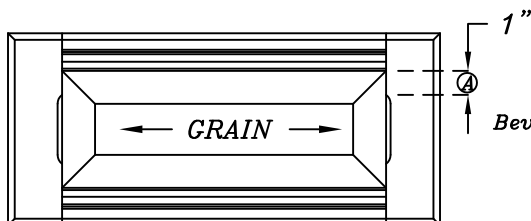

Stiles = 2 1/4"
Rails = 1 9/16"

Bevel stops at 1" of Rails

Heights less than 6 1/8" bevels will stay at 1" but the part (A) will be reduced

Minimum height available = 5 7/8"
Minimum width available = 7 1/4"
(With 1 1/8 visible panel)

5-piece drawer front matches edge profile, framing bead and center panel profile

Doors

Cathedral series

<i>Charter</i>		
<i>Width of rails and stiles</i>	<i>Corresponding models</i>	<i>Page</i>
2"	11620	111
2 1/4"	420	101
2 1/4"	440	102
2 1/4"	520	103
2 1/4"	540	104
2 1/4"	620	105
2 1/4"	640	106
2 1/4"	720	107
2 1/4"	740	108
2 1/2"	120	100
3"	820	109
3"	10920	110

- 1 PROFILES
- 2 TRADITIONAL 90
- 3 DISTINCTIVE 90
- 4 CATHEDRAL 90
- 5 APPLIED MOULDINGS
- 6 PRESTIGE 45
- 7 WAINSCOTS
- 8 SPECIALTY PRODUCTS
- 9 MOULDINGS
- 10 PROMOTIONAL ITEMS
- 11 POLICY

DOOR OPTIONS

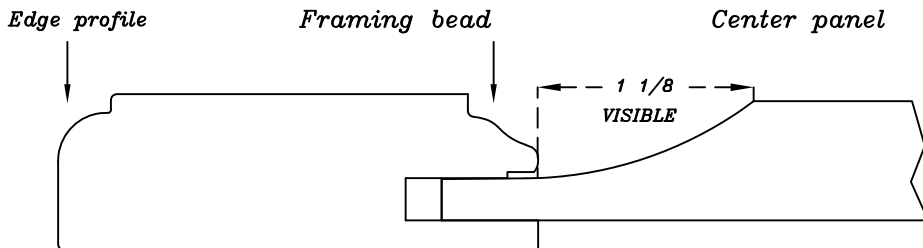

OPTIONS

?	Edge profiles	E-01 to E-58			
?	Framing beads	A/B/F/G/J/K/L/P	C	-	
?	Center panel profiles	Solid	P-01 to P-65	S-01 to S-17	-
		(veneer)	V-01 to V-21	V-01 to V-21	-
		MDF	M-01 to M-75	M-51 to M-517	-
			M-V1 to M-V3	M-V1 to M-V3	-

FRAME OPTIONS

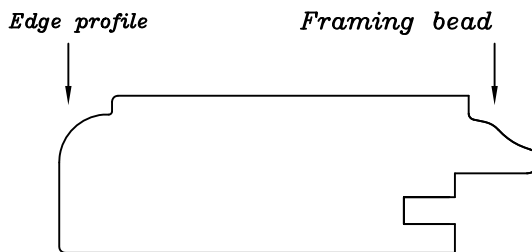

OPTIONS

?	Edge profiles	E-01 to E-58
?	Framing beads	A/B/C/F/G/J/K/L/P

Front Options

Cathedral series

1 PROFILES
2 TRADITIONAL 90
3 DISTINCTIVE 90
4 CATHEDRAL 90
5 APPLIED MOULDINGS
6 PRESTIGE 45
7 WAINSCOTS
8 SPECIALTY PRODUCTS
9 MOULDINGS
10 PROMOTIONAL ITEMS
11 POLICY

FRONT DRAWER SLAB: # 51/?

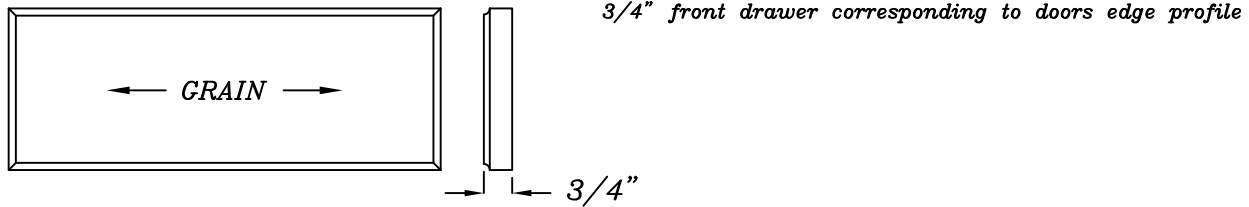

OPTIONS

? Edge profiles E-01 to E-48; EP-01 to EP-53

FRONT DRAWER SLAB: # 54/?

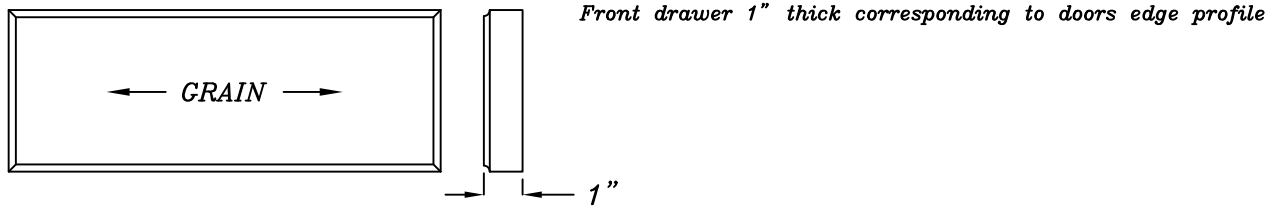

OPTIONS

? Edge profiles E-01 to E-58; EP-01 to EP-53

SLAB: # 503/?

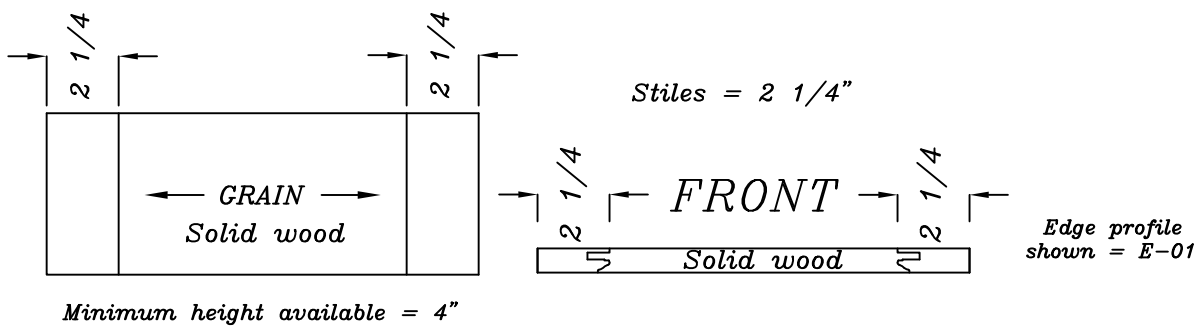

3 piece front drawer corresponding doors edge profile

OPTIONS

? Edge profiles E-01 to E-58

Front Options

Cathedral series

SLAB: # 803/?

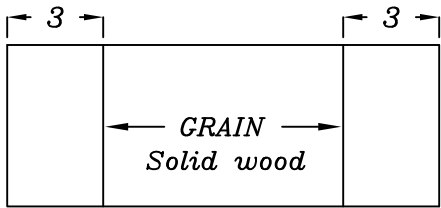

Stiles = 3"



Edge profile shown = E-01

Minimum height available = 4"

3 piece front drawer corresponding doors edge profile

OPTIONS

?	Edge profiles	E-01 to E-58
---	---------------	--------------

SLAB: # 11803/?

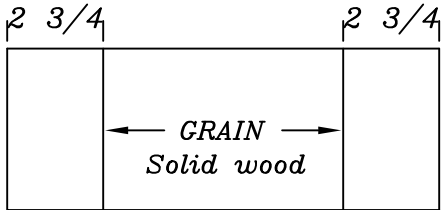

Stiles = 2 3/4"



Edge profile shown = E-01

Minimum height available = 4"

3 piece front drawer corresponding doors edge profile

OPTIONS

?	Edge profiles	E-01 to E-58
---	---------------	--------------

Glass dimension

Width of glass

$$\textcircled{L} - (\textcircled{A} + \textcircled{B}) + 11/16 = \text{width of glass}$$

EX: $12 - (2 \frac{1}{4} + 2 \frac{1}{4}) + 11/16 = 8 \frac{3}{16}$

Height of glass

$$\textcircled{H} - (\textcircled{C} + \textcircled{D}) + 11/16 = \text{height of glass}$$

EX: $24 - (2 \frac{1}{4} + 2 \frac{1}{4}) + 11/16 = 20 \frac{3}{16}$

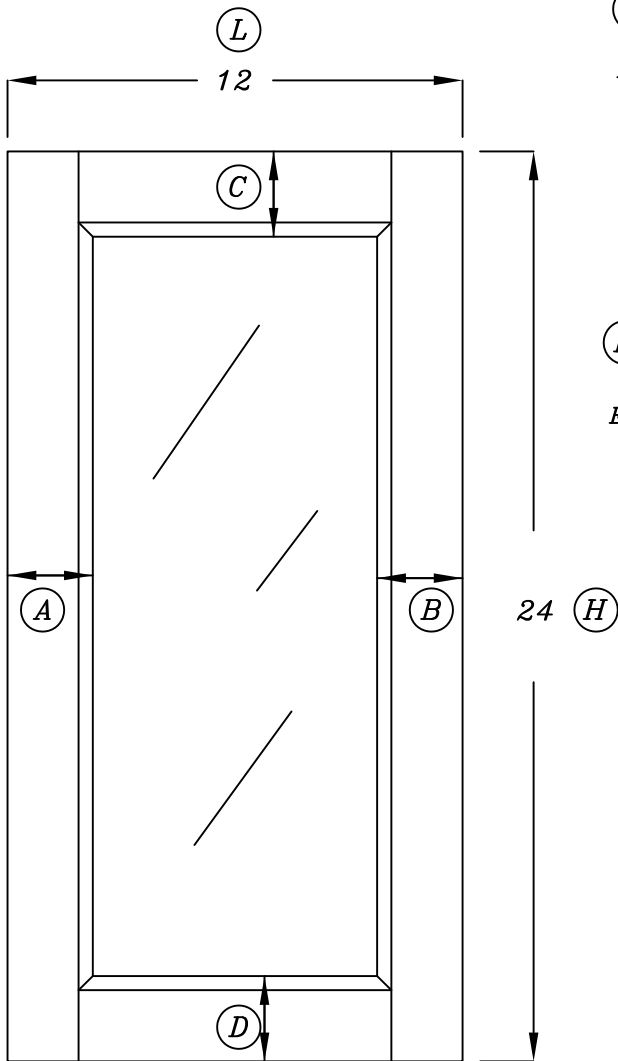

This calculation
leaves a tolerance
between
 $\frac{1}{16}$ '' and $\frac{1}{8}$ ''

- 1 PROFILES
- 2 TRADITIONAL 90
- 3 DISTINCTIVE 90
- 4 CATHEDRAL 90
- 5 APPLIED MOULDINGS
- 6 PRESTIGE 45
- 7 WAINSCOTS
- 8 SPECIALTY PRODUCTS
- 9 MOULDINGS
- 10 PROMOTIONAL ITEMS
- 11 POLICY

Frame options

Cathedral series

FRAME LITE OPTIONS

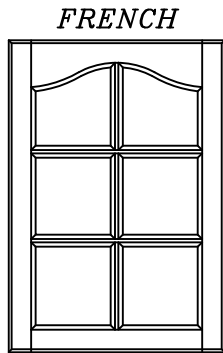

MULLION ALIGNMENT

Height

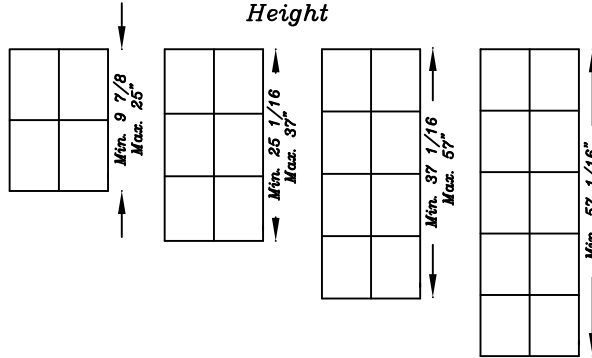

Width

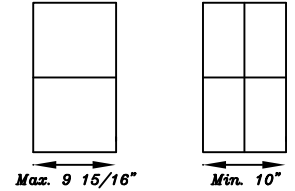

OPTIONS

?	Edge profiles	E-01 to E-58
?	Framing beads	A/B/C/F/G/J/K/L/P
?	Amount of tiles	0/2/3/4/6/8/9/10

FRAME LITE OPTIONS

<i>Mullion models</i>	<i>Framing beads</i>
<p>ACT08</p>	A/F/G/P
<p>M049</p>	B
<p>M011</p>	C/D/J
<p>ACT16</p>	K
<p>ACT15</p>	L

1
PROFILES

2
TRADITIONAL
90

3
DISTINCTIVE
90

4
CATHEDRAL
90

5
APPLIED
MOULDINGS

6
PRESTIGE
45

7
WANSCOTS

8
SPECIALTY
PRODUCTS

9
MOULDINGS

10
PROMOTIONAL
ITEMS

11
POLICY

DOOR # 120/???

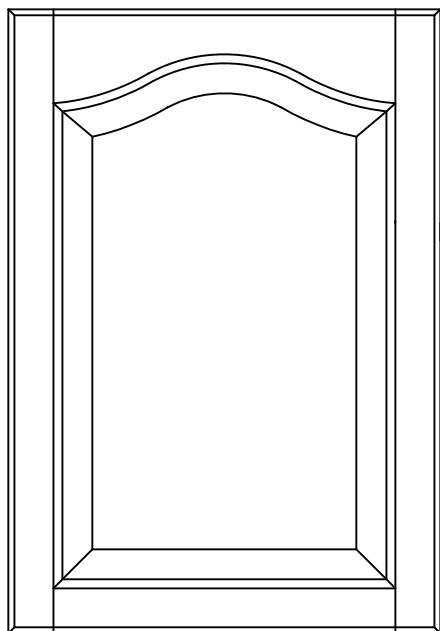

Minimum width (solid) = 7 1/2" (veneer) = 6"
Minimum height (solid) = 8 7/8" (veneer) = 7 5/8"

FRAME # 125/???

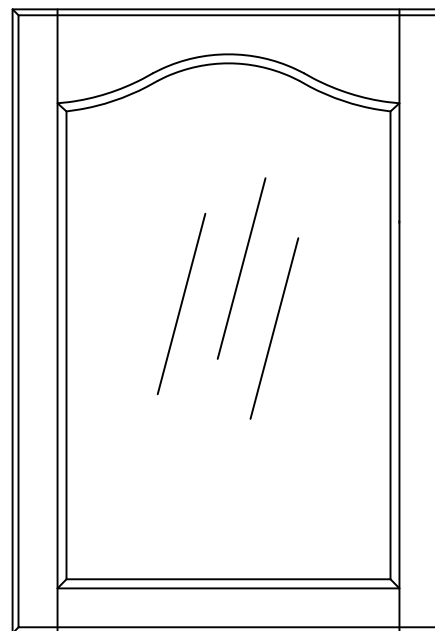

Minimum width = 6"
Minimum height = 7 5/8"

Edge profile shown = E-04

Framing bead shown = A

Center panel shown = P-03

Take note that the design of door width less than 10 1/2" can differ from the principal image

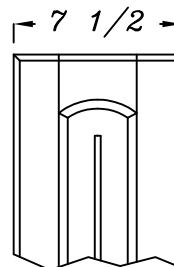
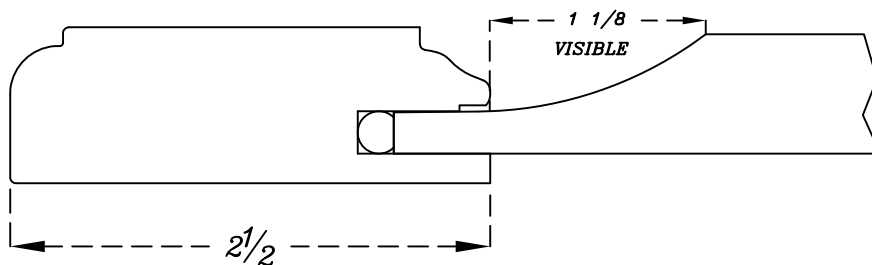

5-PIECE DRAWER FRONT: # 101/???

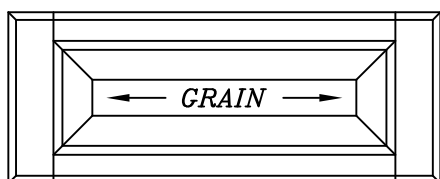

Stiles = 2 1/2"
Rails = 1 1/2"

Minimum height available = 5 3/4"
Minimum width available = 7 3/4"
(With 1 1/8" of visible panel)

Door's edge profile, framing bead and center panel profile match the corresponding door.

Doors

Cathedral series

- 1 PROFILES
- 2 TRADITIONAL 90
- 3 DISTINCTIVE 90
- 4 CATHEDRAL 90
- 5 APPLIED MOULDINGS
- 6 PRESTIGE 45
- 7 WANSCOTS
- 8 SPECIALTY PRODUCTS
- 9 MOULDINGS
- 10 PROMOTIONAL ITEMS
- 11 POLICY

DOOR # 420/???

FRAME # 425/???

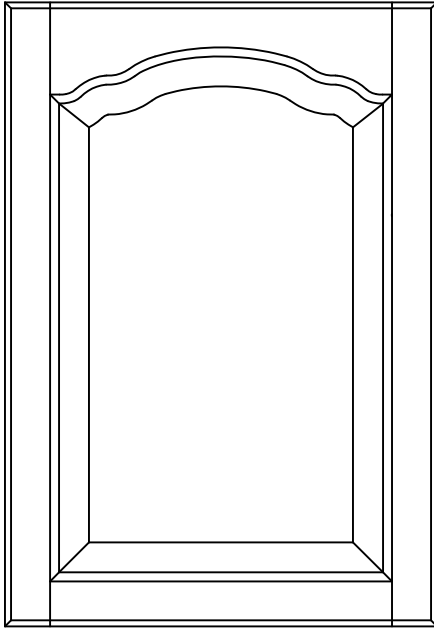

Minimum width (solid) = 7" (veneer) = 6"
 Minimum height (solid) = 9 1/4" (veneer) = 8"

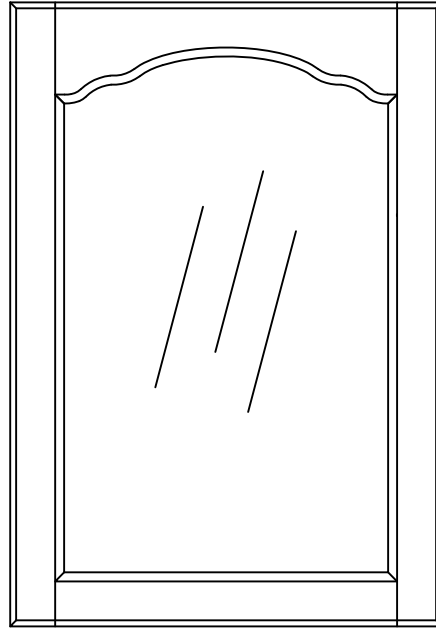

Minimum width = 6"
 Minimum height = 8"

Edge profile shown = E-04

Framing bead shown = A

Center panel shown = P-03

Take note that the design of door width less than 10 1/2" can differ from the principal image

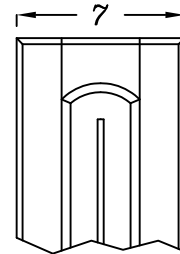
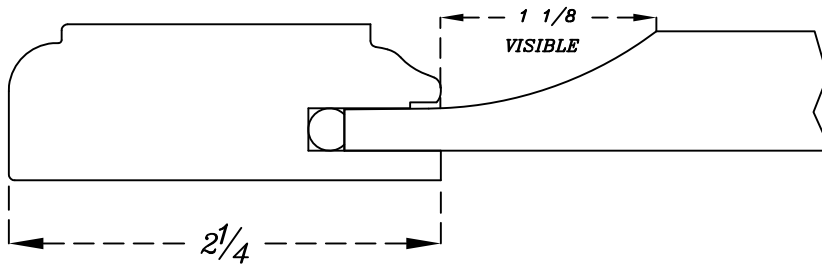

5-PIECES DRAWER FRONT: # 501/???

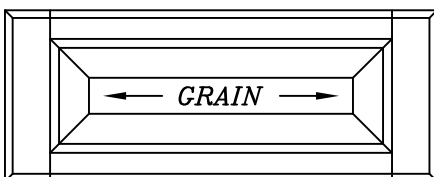

Minimum height available = 5 7/8"
 Minimum width available = 7 1/4"
 (With 1 1/8" of visible panel)

Stiles = 2 1/4"
 Rails = 1 9/16"

Match corresponding door's edge profile framing bead and center panel profile

Doors

Cathedral series

DOOR # 440/???

FRAME # 445/???

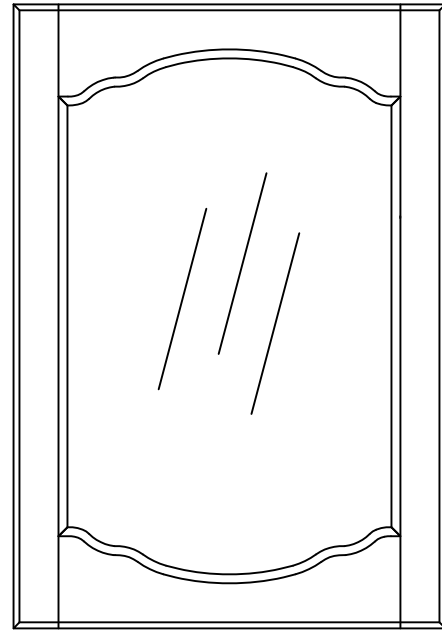
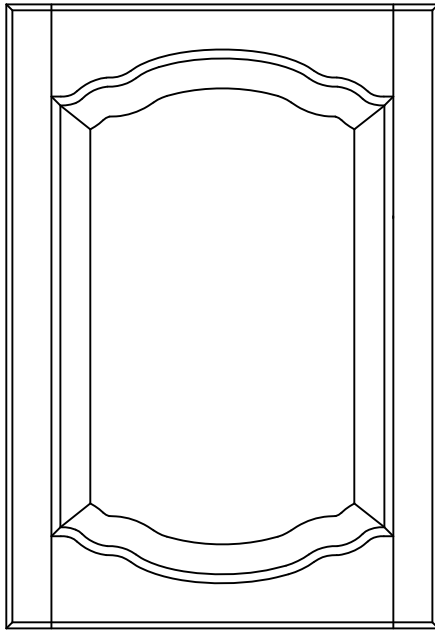

Minimum width (solid) = 7" (veneer) = 6"
Minimum height (solid) = 12" (veneer) = 9 3/4"

Minimum width = 6"
Minimum height = 9 3/4"

Take note that the design of door that the width less than 10 1/2" can differ from the principal image

Edge profile shown = E-04

Framing bead shown = A

Center panel shown = P-03

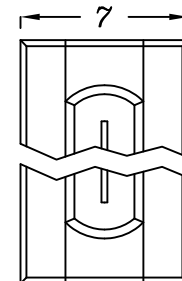
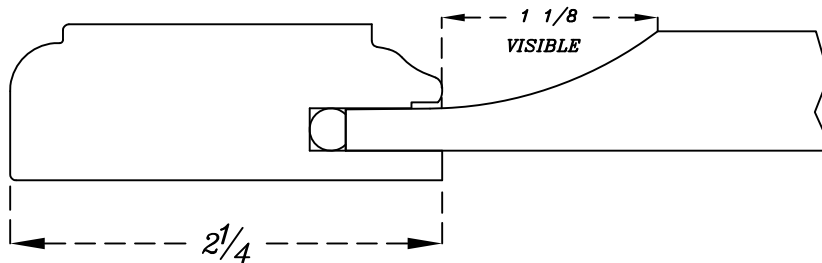

5-PIECES DRAWER FRONT: # 501/???

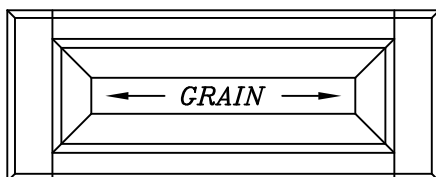

Stiles = 2 1/4"
Rails = 1 9/16"

Match corresponding door's edge profile framing bead and center panel profile

Minimum height available = 5 7/8"
Minimum width available = 7 1/4"
(With 1 1/8" of visible panel)

Doors

Cathedral series

- 1 PROFILES
- 2 TRADITIONAL 90
- 3 DISTINCTIVE 90
- 4 CATHEDRAL 90
- 5 APPLIED MOULDINGS
- 6 PRESTIGE 45
- 7 WAINSCOTS
- 8 SPECIALTY PRODUCTS
- 9 MOULDINGS
- 10 PROMOTIONAL ITEMS
- 11 POLICY

DOOR # 520/???

FRAME # 525/???

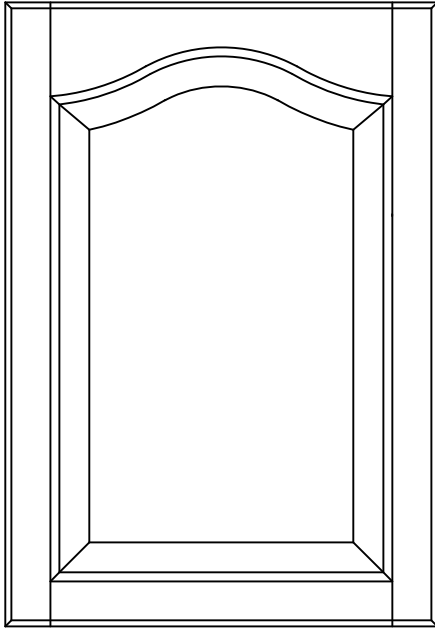

Minimum width (solid) = 7" (veneer) = 6"
 Minimum height (solid) = 8 7/8" (veneer) = 7 5/8"

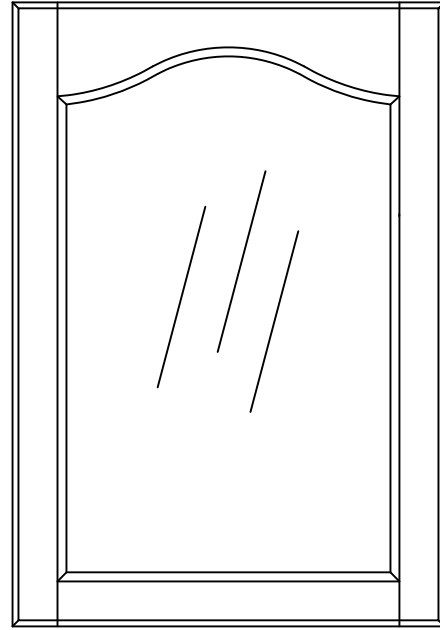

Minimum width = 6"
 Minimum height = 7 5/8"

Edge profile shown = E-04

Framing bead shown = A

Center panel shown = P-03

Take note that the design of door width less than 10 1/2" can differ from the principal image

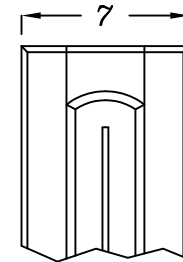
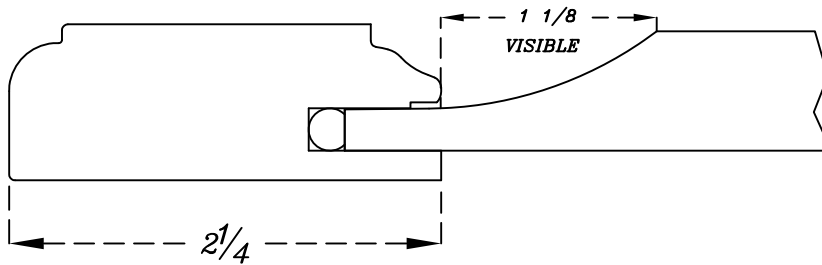

5-PIECES DRAWER FRONT: # 501/???

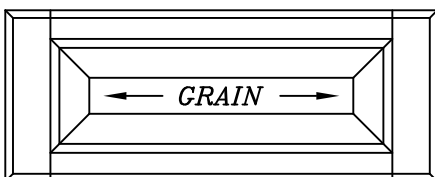

Minimum height available = 5 7/8"
 Minimum width available = 7 1/4"
 (With 1 1/8" of visible panel)

Stiles = 2 1/4"
 Rails = 1 9/16"

Match corresponding door's edge profile framing bead and center panel profile

Doors

Cathedral series

DOOR # 540/???

FRAME # 545/???

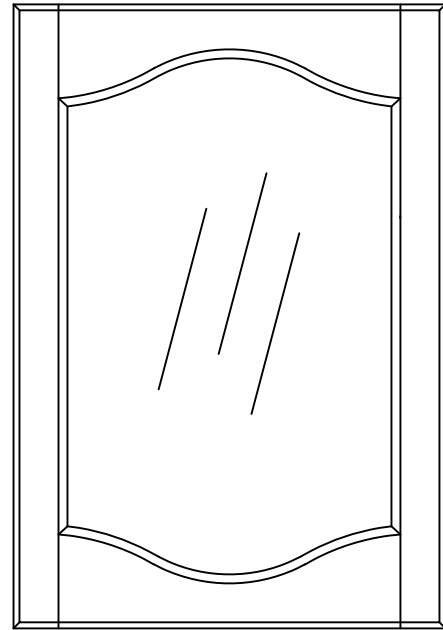
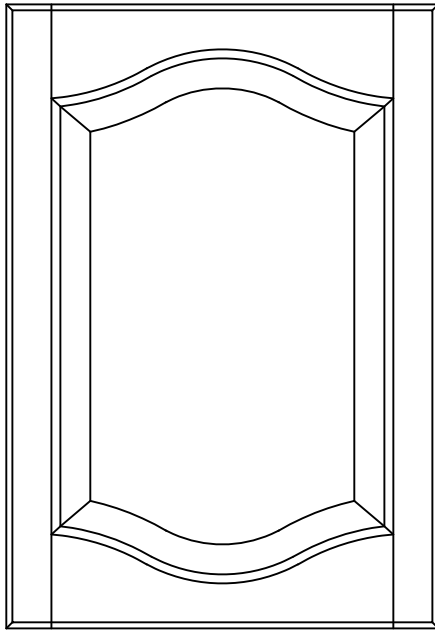

Minimum width (solid) = 7" (veneer) = 6"
Minimum height (solid) = 11 1/4" (veneer) = 9"

Minimum width = 6"
Minimum height = 9"

Edge profile shown = E-04

Framing bead shown = A

Center panel shown = P-03

Take note that the design of door width less than 10 1/2" can differ from the principal image

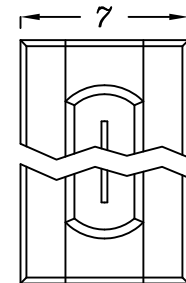
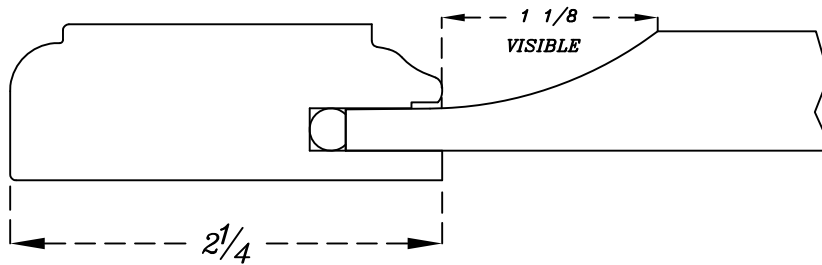

5-PIECES DRAWER FRONT: # 501/???

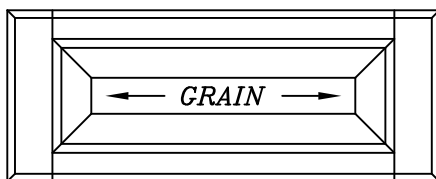

Stiles = 2 1/4"
Rails = 1 9/16"

Match corresponding door's edge profile framing bead and center panel profile

Minimum height available = 5 7/8"
Minimum width available = 7 1/4"
(With 1 1/8" of visible panel)

Doors

Cathedral series

- 1 PROFILES
- 2 TRADITIONAL 90
- 3 DISTINCTIVE 90
- 4 CATHEDRAL 90
- 5 APPLIED MOULDINGS
- 6 PRESTIGE 45
- 7 WAINSCOTS
- 8 SPECIALTY PRODUCTS
- 9 MOULDINGS
- 10 PROMOTIONAL ITEMS
- 11 POLICY

DOOR # 620/???

FRAME # 625/???

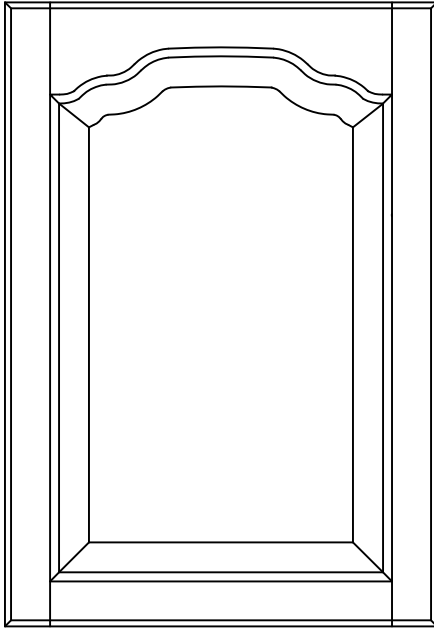

Minimum width (solid) = 7" (veneer) = 6"
 Minimum height (solid) = 9 1/4" (veneer) = 8"

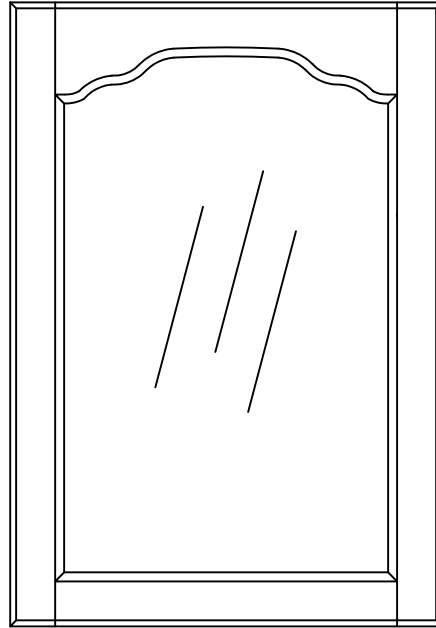

Minimum width = 6"
 Minimum height = 8"

Edge profile shown = E-04

Framing bead shown = A

Center panel shown = P-03

Take note that the design of door width less than 10 1/2" can differ from the principal image

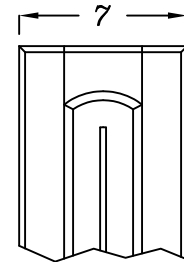
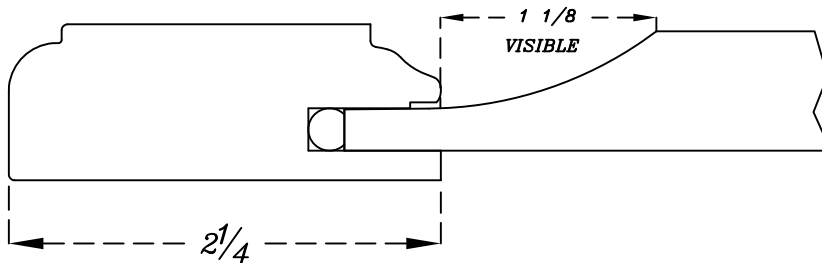

5-PIECES DRAWER FRONT: # 501/???

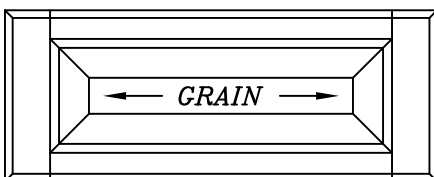

Minimum height available = 5 7/8"
 Minimum width available = 7 1/4"
 (With 1 1/8" of visible panel)

Stiles = 2 1/4"
 Rails = 1 9/16"

Match corresponding door's edge profile framing bead and center panel profile

Doors

Cathedral series

DOOR # 640/???

FRAME # 645/???

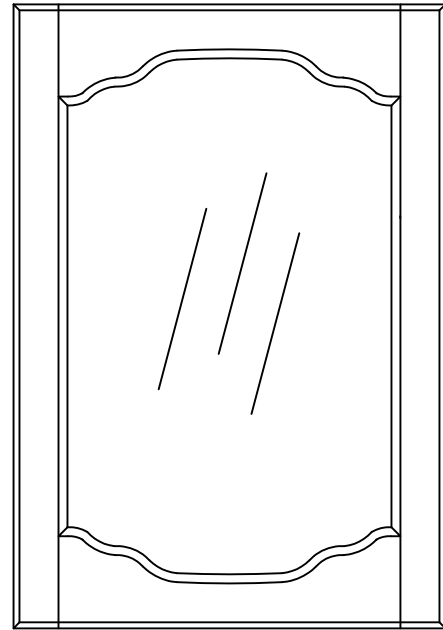
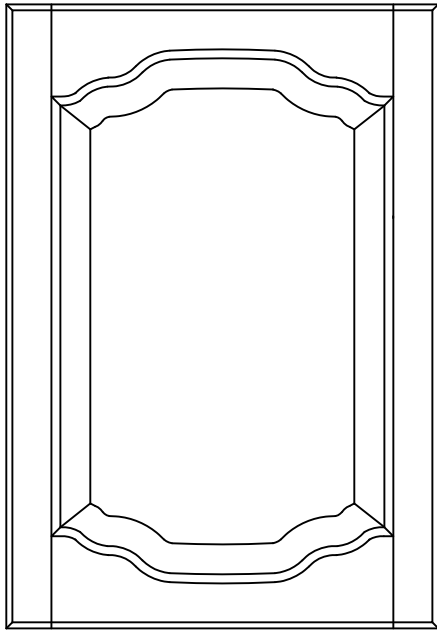

Minimum width (solid) = 7" (veneer) = 6"
Minimum height (solid) = 12" (veneer) = 9 3/4"

Minimum width = 6"
Minimum height = 9 3/4"

Edge profile shown = E-04

Framing bead shown = A

Center panel shown = P-03

Take note that the design of door width less than 10 1/2" can differ from the principal image

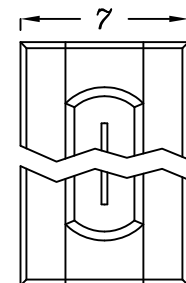
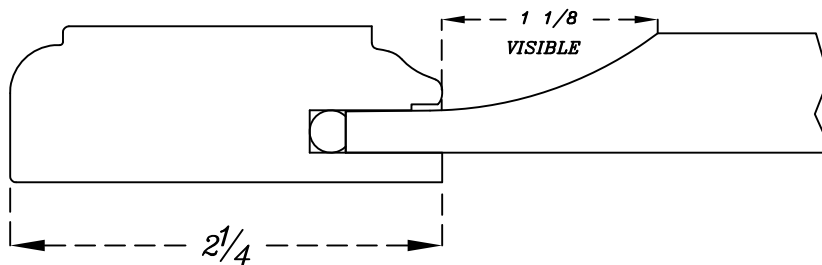

5-PIECES DRAWER FRONT: # 501/???

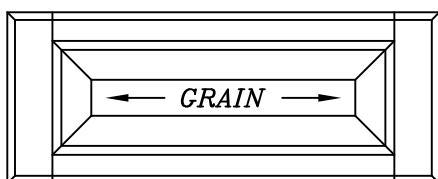

Stiles = 2 1/4"
Rails = 1 9/16"

Match corresponding door's edge profile framing bead and center panel profile

Minimum height available = 5 7/8"
Minimum width available = 7 1/4"
(With 1 1/8" of visible panel)

Doors

Cathedral series

- 1 PROFILES
- 2 TRADITIONAL 90
- 3 DISTINCTIVE 90
- 4 CATHEDRAL 90
- 5 APPLIED MOULDINGS
- 6 PRESTIGE 45
- 7 WAINSCOTS
- 8 SPECIALTY PRODUCTS
- 9 MOULDINGS
- 10 PROMOTIONAL ITEMS
- 11 POLICY

DOOR # 720/???

FRAME # 725/???

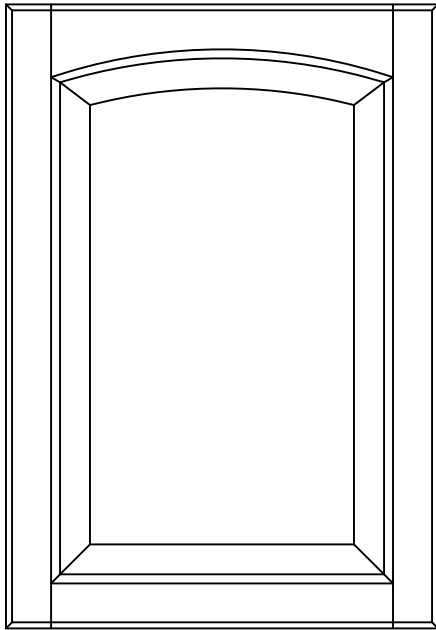

Minimum width (solid) = 7" (veneer) = 6"
 Minimum height (solid) = 8 1/4" (veneer) = 7"

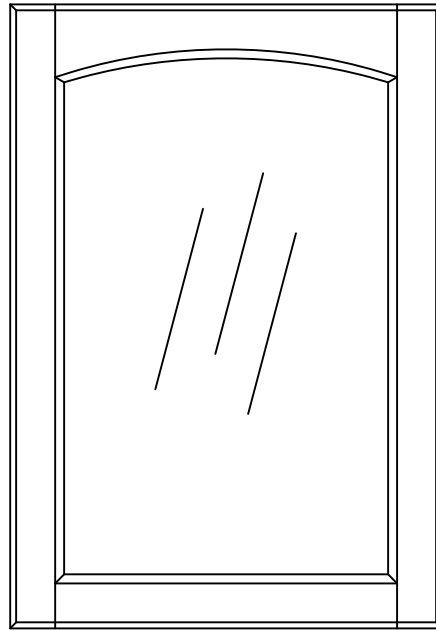

Minimum width = 6"
 Minimum height = 7"

Take note that the design of door width less than 10 1/2" can differ from the principal image

Edge profile shown = E-04

Framing bead shown = A

Center panel shown = P-03

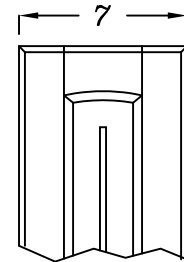
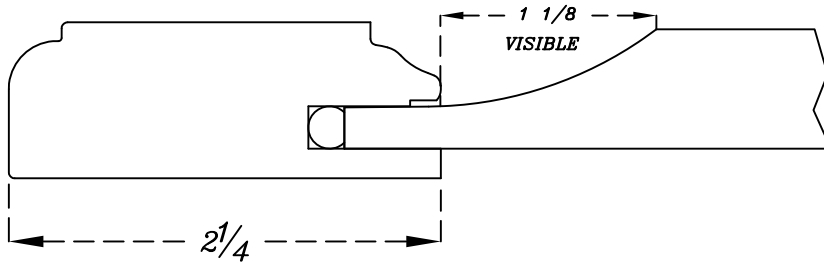

5-PIECES DRAWER FRONT: # 501/???

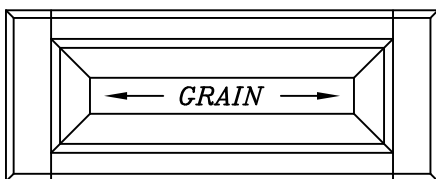

Minimum height available = 5 7/8"
 Minimum width available = 7 1/4"
 (With 1 1/8" of visible panel)

Stiles = 2 1/4"
 Rails = 1 9/16"

Match corresponding door's edge profile framing bead and center panel profile

Doors

Cathedral series

DOOR # 740/???

FRAME # 745/???

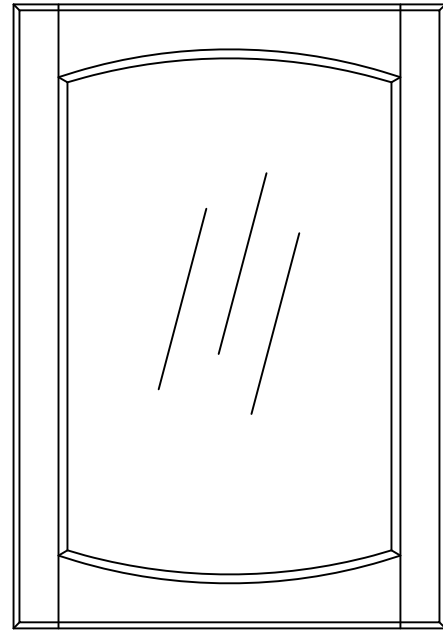
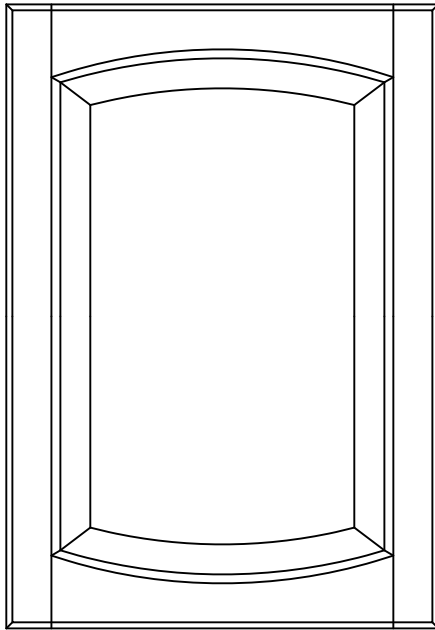

Minimum width (solid) = 7" (veneer) = 6"
Minimum height (solid) = 10" (veneer) = 7 3/4"

Minimum width = 6"
Minimum height = 7 3/4"

Edge profile shown = E-04

Framing bead shown = A

Center panel shown = P-03

Take note that the design of door width less than 10 1/2" can differ from the principal image

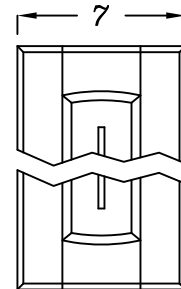
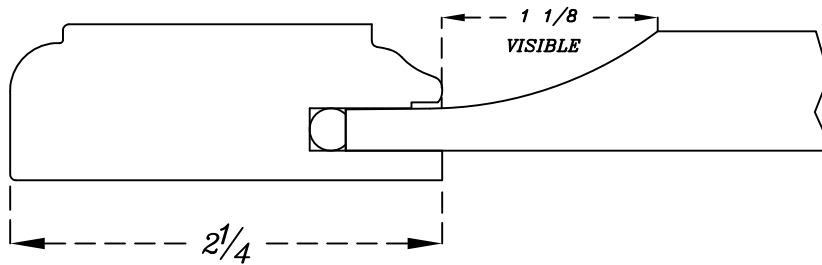

5-PIECES DRAWER FRONT: # 501/???

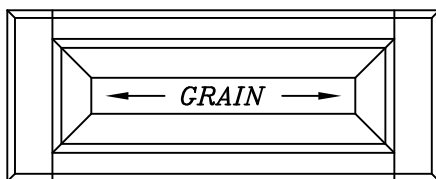

Stiles = 2 1/4"
Rails = 1 9/16"

Match corresponding door's edge profile framing bead and center panel profile

Minimum height available = 5 7/8"
Minimum width available = 7 1/4"
(With 1 1/8" of visible panel)

Doors

Cathedral series

- 1 PROFILES
- 2 TRADITIONAL 90
- 3 DISTINCTIVE 90
- 4 CATHEDRAL 90
- 5 APPLIED MOULDINGS
- 6 PRESTIGE 45
- 7 WAINSCOTS
- 8 SPECIALTY PRODUCTS
- 9 MOULDINGS
- 10 PROMOTIONAL ITEMS
- 11 POLICY

DOOR # 820/???

FRAME # 825/???

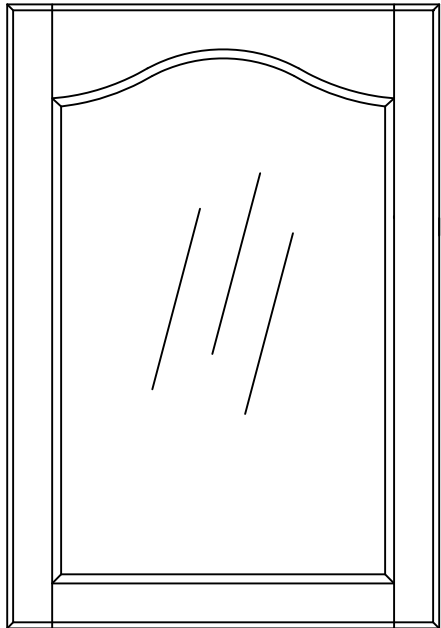
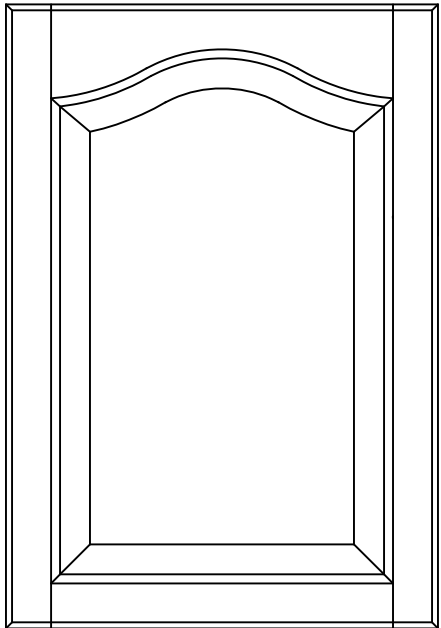

*Minimum width (solid) = 8 1/2" (veneer) = 7 1/2"
Minimum height (solid) = 10 3/8" (veneer) = 9 1/8"*

*Minimum width = 7 1/2"
Minimum height = 9 1/8"*

****Take note that the design of door width less than 10 1/2" can differ from the principal image****

Edge profile shown = E-04

Framing bead shown = A

Center panel shown = P-03

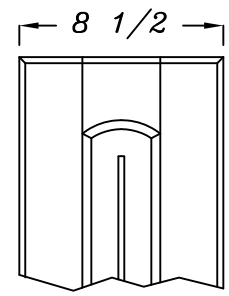
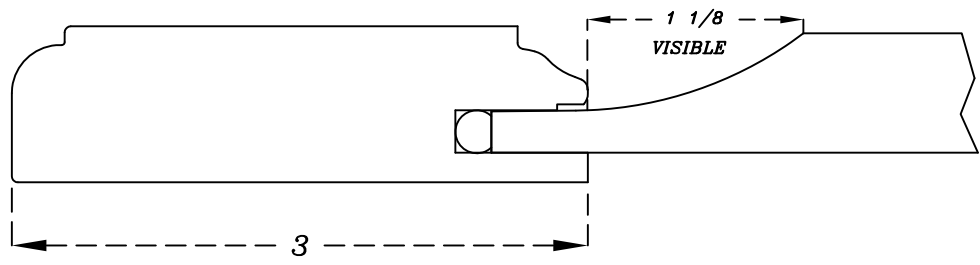

5-PIECES DRAWER FRONT: # 801/???

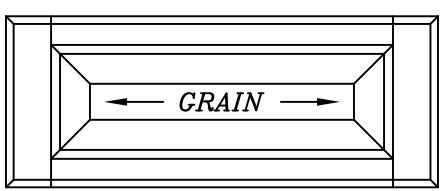

*Stiles = 3"
Rails = 1 9/16"*

Match corresponding door's edge profile framing bead and center panel profile

*Minimum height available = 5 7/8"
Minimum width available = 8 3/4"
(With 1 1/8" of visible panel)*

DOOR # 10920/???

FRAME # 10925/???

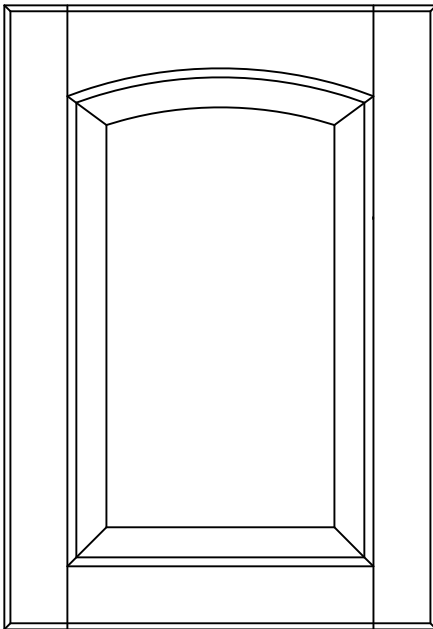

Minimum width (solid) = 8 1/2" (veneer) = 7 1/2"
Minimum height (solid) = 9 3/4" (veneer) = 8 1/2"

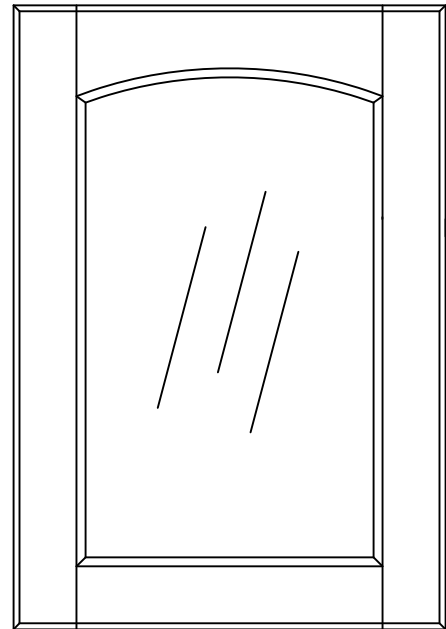

Minimum width and height = 8 1/2"

Edge profile shown = E-04

Framing bead shown = A

Center panel shown = P-03

Take note that the design of door width less than 10 1/2" can differ from the principal image

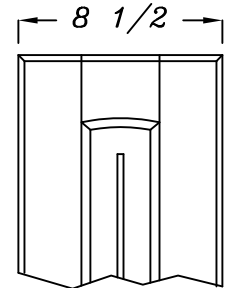
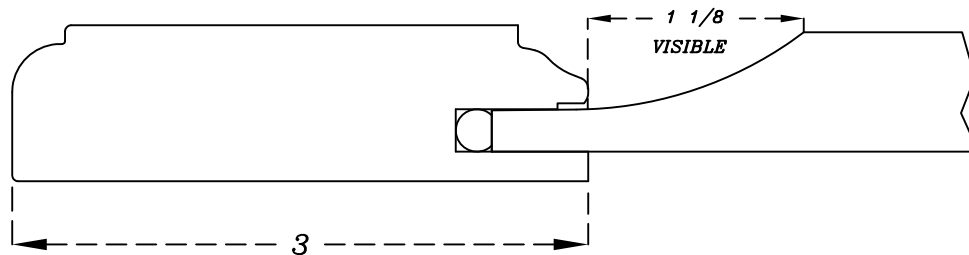

5-PIECE DRAWER FRONT: # 10901/???

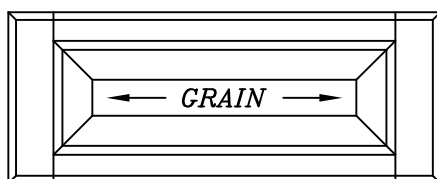

Stiles = 3"
Rails = 1 9/16"

Minimum height available = 5 7/8"
Minimum width available = 8 3/4"
(With 1 1/8" of visible panel)

Door's edge profile, framing bead and center panel profile match the corresponding door.

Doors

Cathedral series

- 1 PROFILES
- 2 TRADITIONAL 90
- 3 DISTINCTIVE 90
- 4 CATHEDRAL 90
- 5 APPLIED MOULDINGS
- 6 PRESTIGE 45
- 7 WAINSCOTS
- 8 SPECIALTY PRODUCTS
- 9 MOULDINGS
- 10 PROMOTIONAL ITEMS
- 11 POLICY

DOOR # 11620/???

FRAME # 11625/???

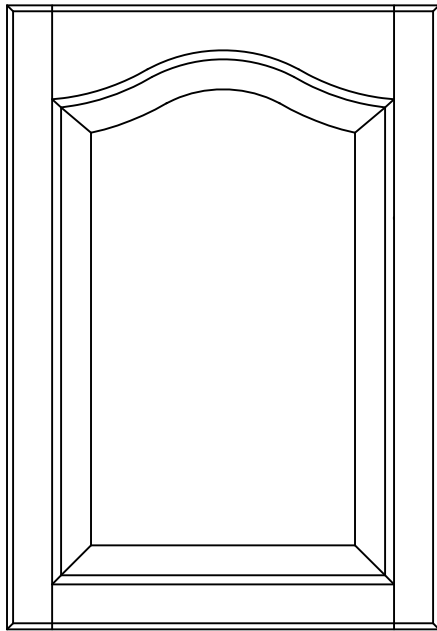

Minimum width and height (Solid) = 6 1/2"
Minimum width and height (veneer) = 5 1/2"

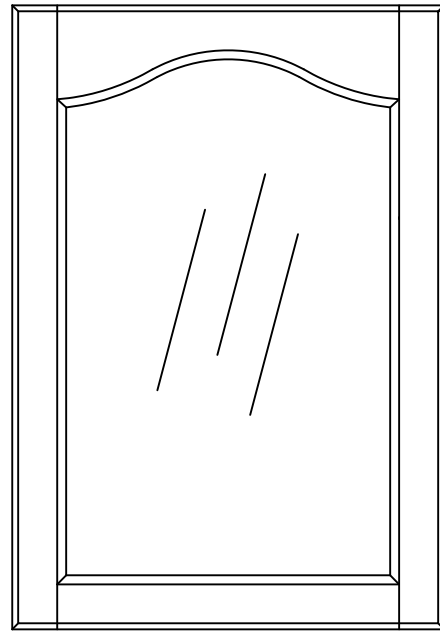

Minimum width and height = 5 1/2"

Edge profile shown = E-04

Framing bead shown = A

Center panel shown = P-03

Take note that the design of door width less than 10 1/2" can differ from the principal image

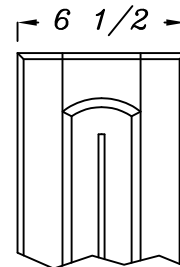
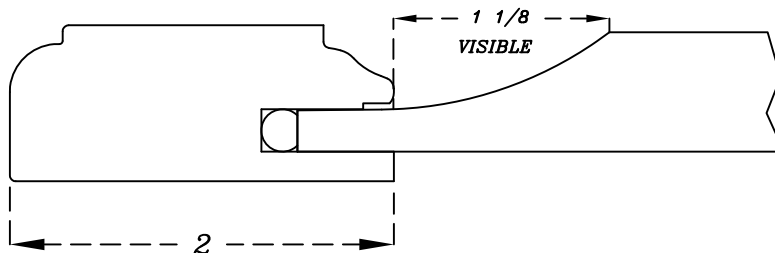

5-PIECE DRAWER FRONT: # 11601/???

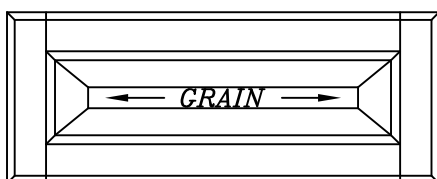

Minimum height available = 6 3/4"
Minimum width available = 6 3/4"
(With 1 1/8" of visible panel)

Stiles = 2"
Rails = 2"

Door's edge profile, framing bead and center panel profile match the corresponding door.

Applied mouldings on frame

Door # X00/??#+ (Applied Mouldings)

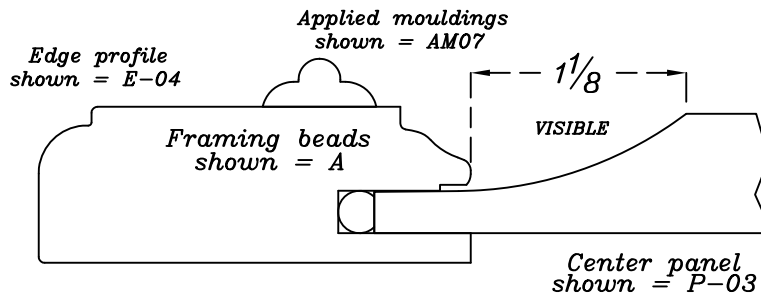

Only available in the traditional series except for the models 11000, 11100 and 12100

SLAB DRAWER FRONT: # 51/?+ (Applied Mouldings)

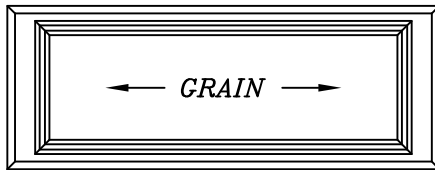

Door's edge profile corresponding to the doors with applied mouldings corresponding to the 5 piece drawer front disposition.

DRAWER FRONT: # X01/??#+ (Applied Mouldings)

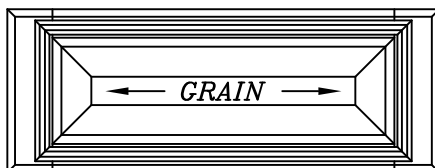

Door's edge profile, framing bead and center panel profile match the corresponding door.

Note that some applied mouldings require wider rails, thereby increasing minimum heights

Mouldings on frame available

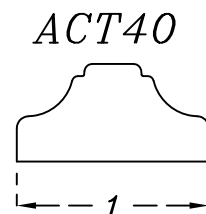
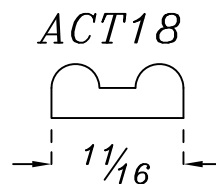
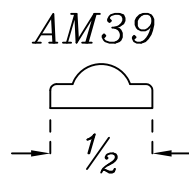
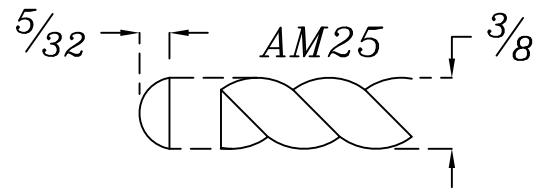
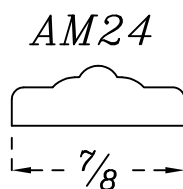
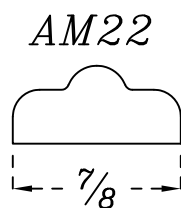
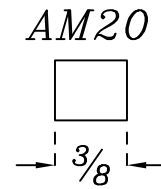
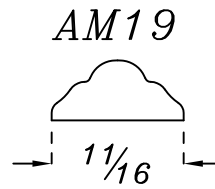
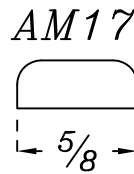
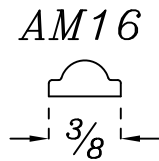
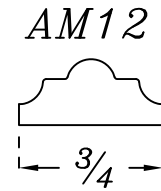
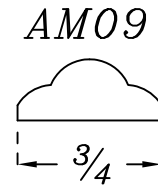
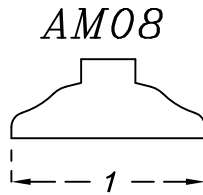
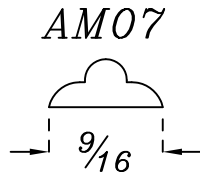
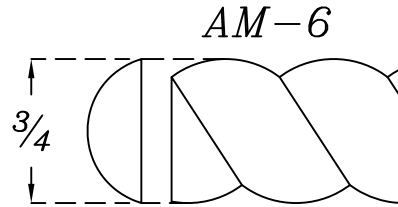
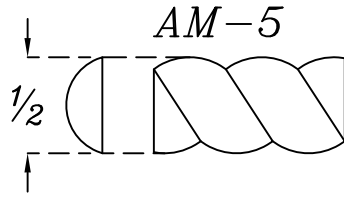

Applied mouldings on center panel

Door # X00/C/??+ (Applied Mouldings)

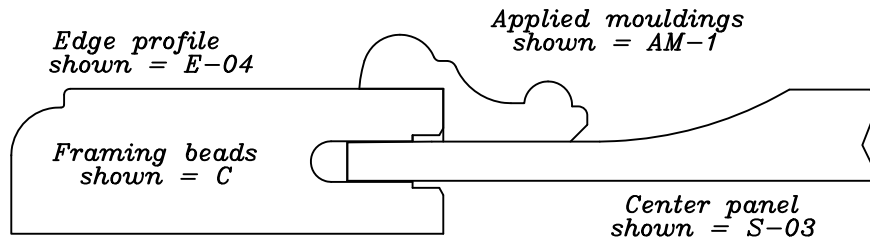

Only available in the traditional series except the models 11000, 11100 et 12100

SLAB DRAWER FRONT: # 51/?+ (Applied Mouldings)

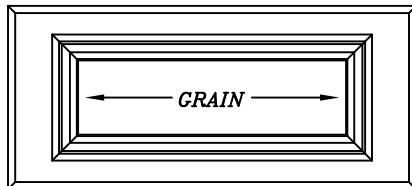

Door's edge profile corresponding to the doors with applied mouldings corresponding to the 5 pièce drawer front disposition.

DRAWER FRONT: # X01/C/??+ (Applied Mouldings)

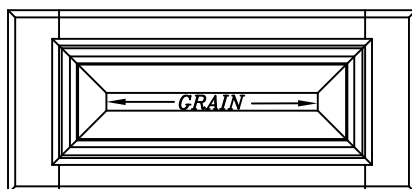

Door's edge profile, framing bead and center panel profile match the corresponding door.

Note that the minimum height will be increasing from the standard heights

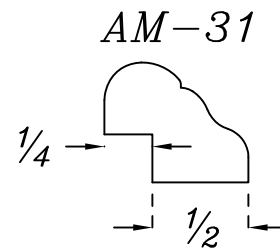
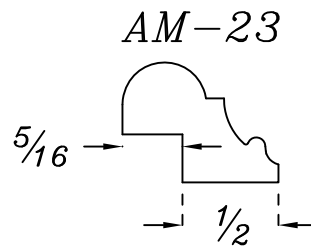
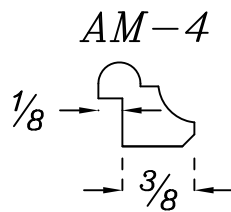
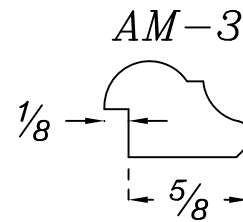
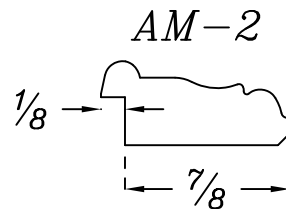
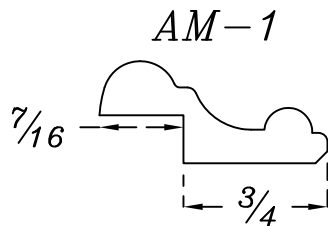
*Mouldings on center panel**Using the "C" Framing beads*

Applied mouldings on center panel

Door # X00/J/??+ (Applied Mouldings)

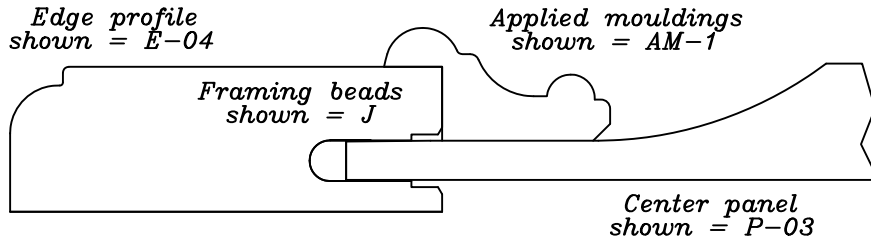

Only available in the traditional series

SLAB DRAWER FRONT: # 51/?+ (Applied Mouldings)

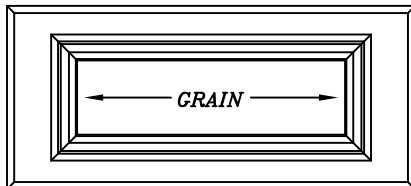

Door's edge profile corresponding to the doors with applied mouldings corresponding to the 5 piece drawer front disposition.

DRAWER FRONT: # X01/C/??+ (Applied Mouldings)

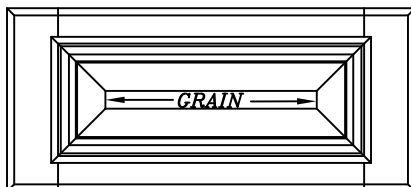

Door's edge profile, framing bead and center panel profile match the corresponding door.

Note that the minimum height will be increasing from the standard heights

Mouldings on center panel

Using the "J" Framing beads

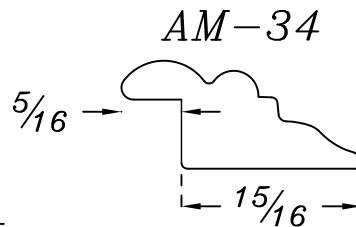
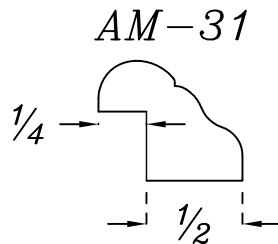
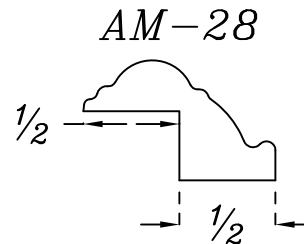
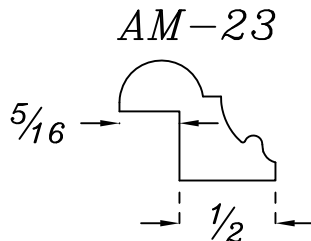
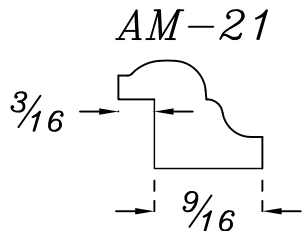
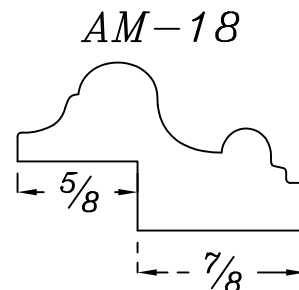
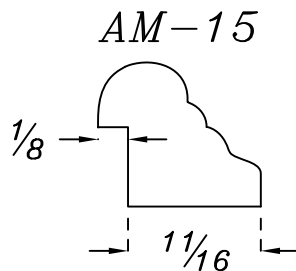
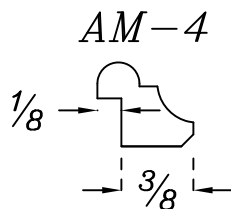
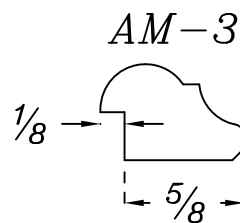
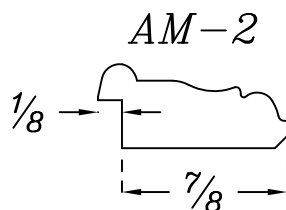
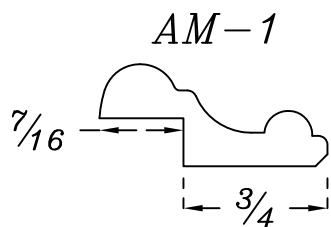

Profiles

Prestige series

Mitered door

Doors

Drawers

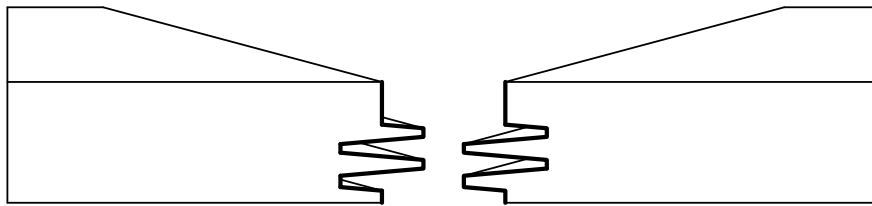

Assembly of the prestige series is made with finger joint

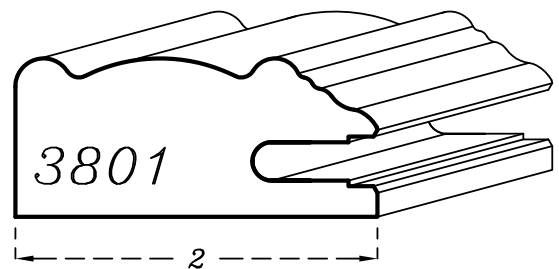
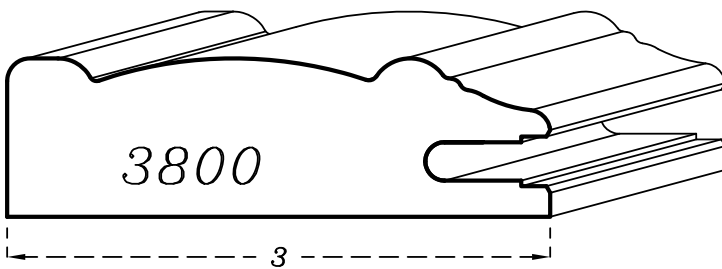
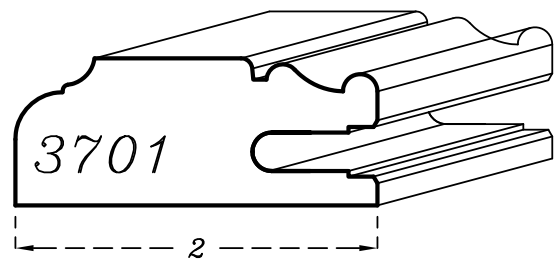
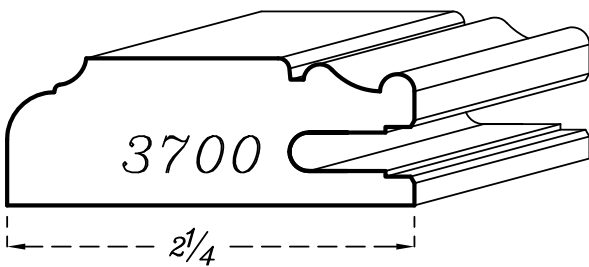

- 1 PROFILES
- 2 TRADITIONAL 90
- 3 DISTINCTIVE 90
- 4 CATHEDRAL 90
- 5 APPLIED MOULDINGS
- 6 PRESTIGE 45
- 7 WAINSCOTS
- 8 SPECIALTY PRODUCTS
- 9 MOULDINGS
- 10 PROMOTIONAL ITEMS
- 11 POLICY

Profiles

Prestige series

Mitered door

Doors

Drawers

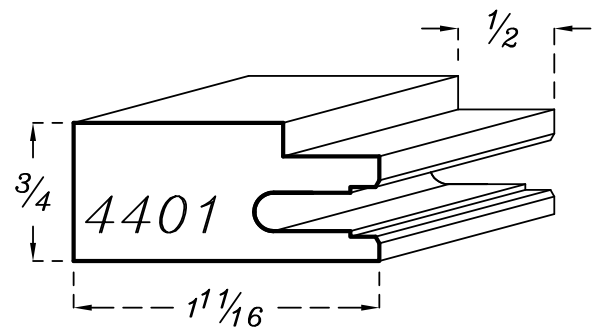
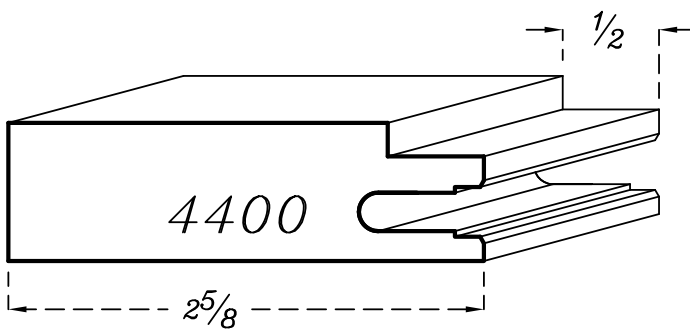
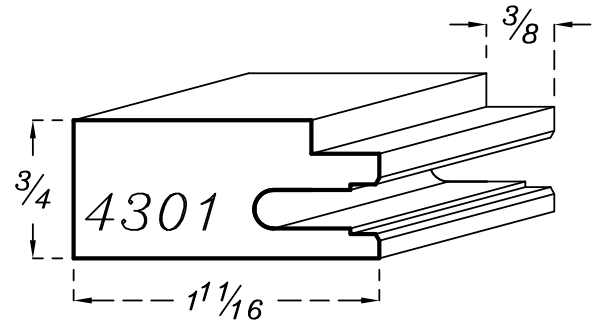
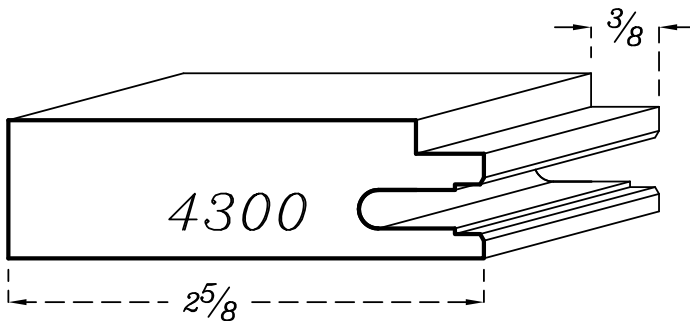
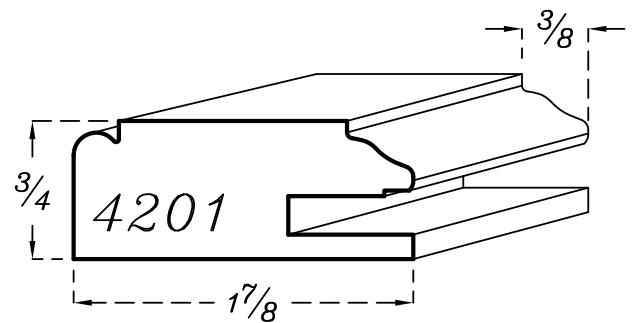
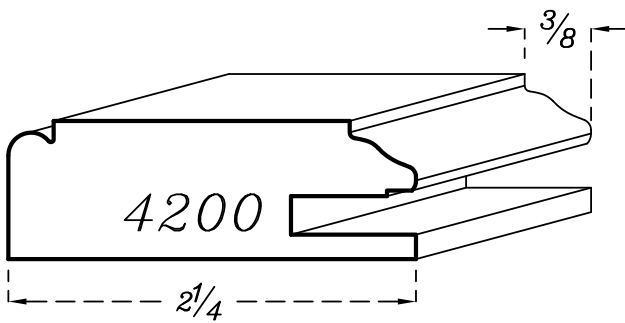
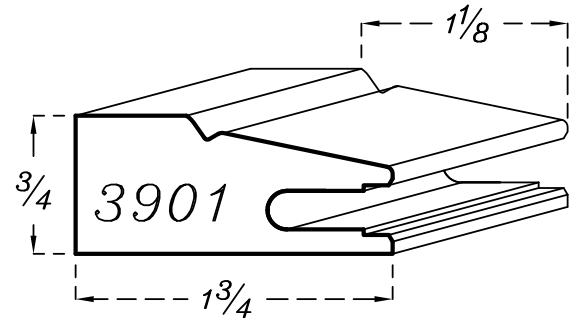
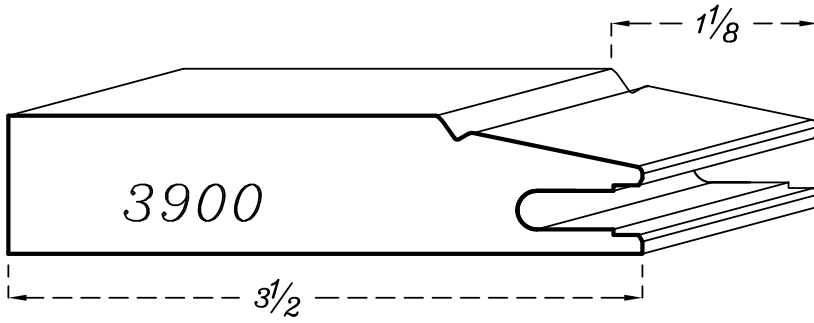

Profiles

Prestige series

Mitered door

Doors

Drawers

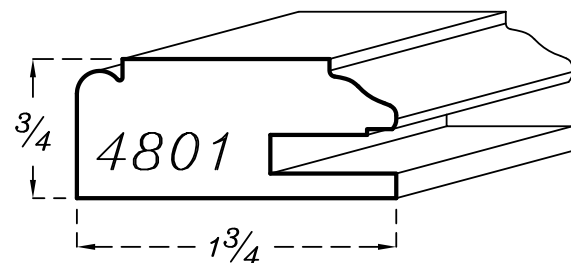
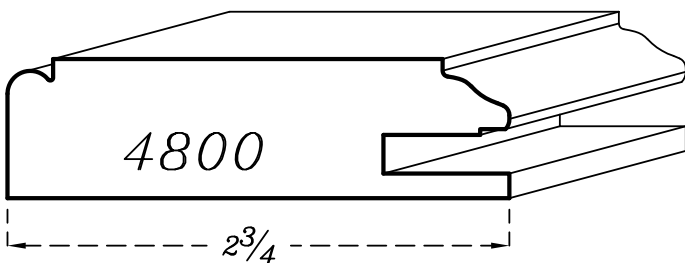
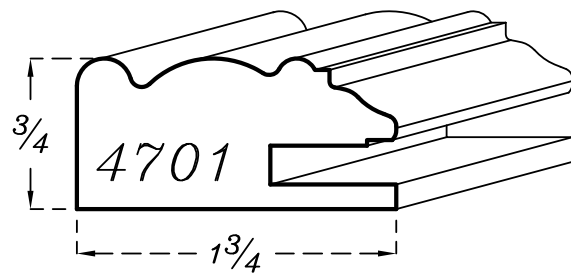
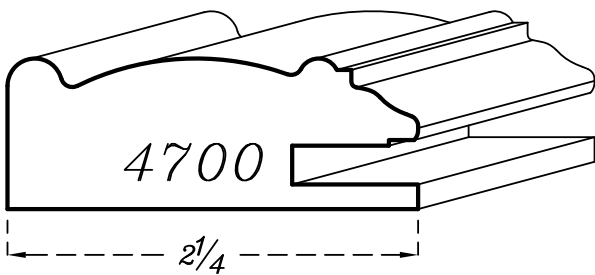
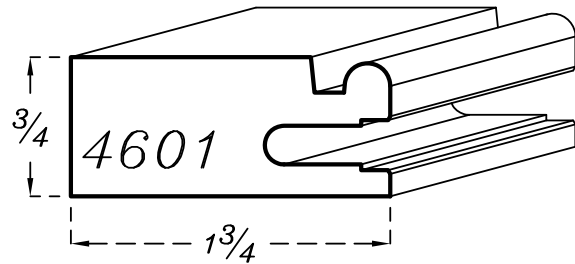
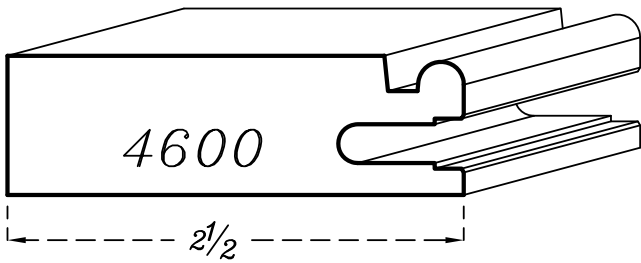
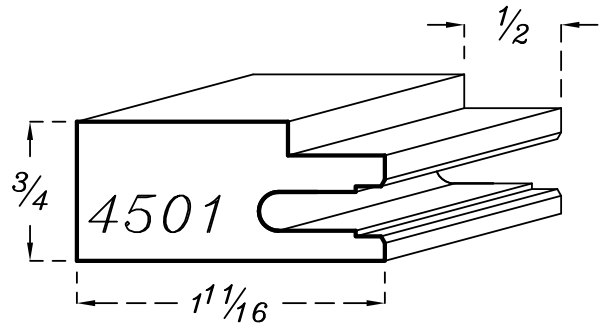
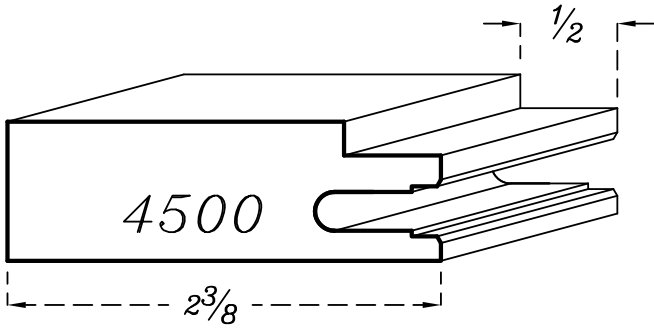

- 1 PROFILES
- 2 TRADITIONAL 90
- 3 DISTINCTIVE 90
- 4 CATHEDRAL 90
- 5 APPLIED MOULDINGS
- 6 **PRESTIGE 45**
- 7 WANNSCOTS
- 8 SPECIALTY PRODUCTS
- 9 MOULDINGS
- 10 PROMOTIONAL ITEMS
- 11 POLICY

Profiles

Prestige series Mitered door

Doors

Drawers

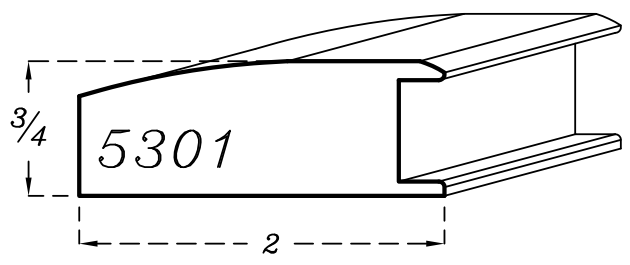
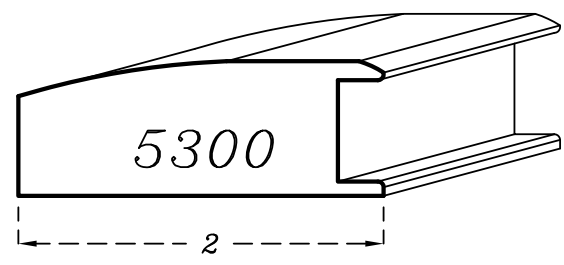
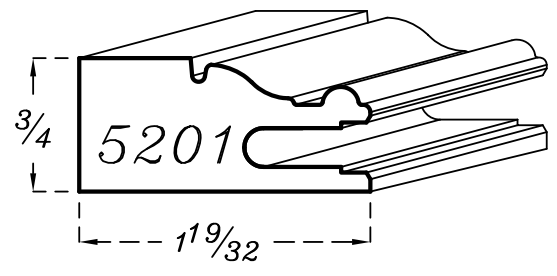
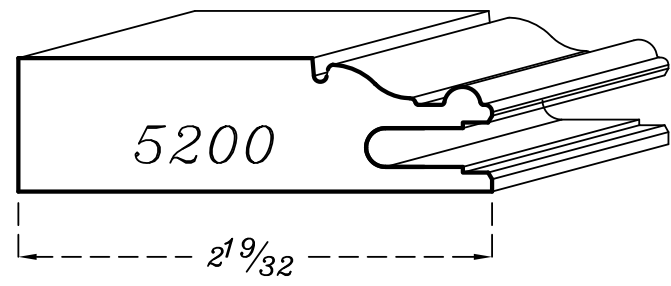
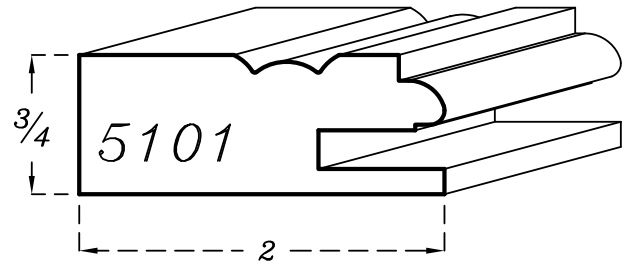
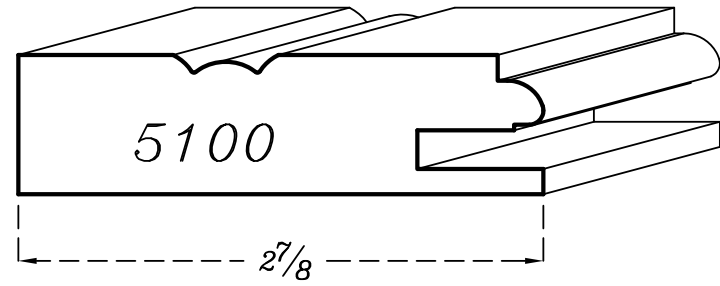
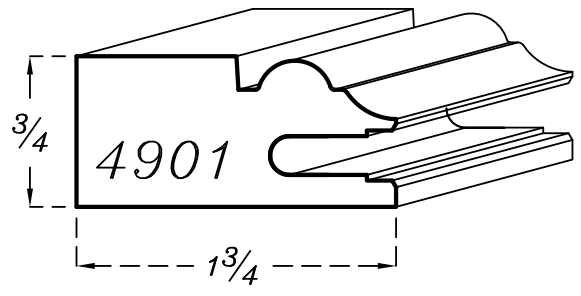
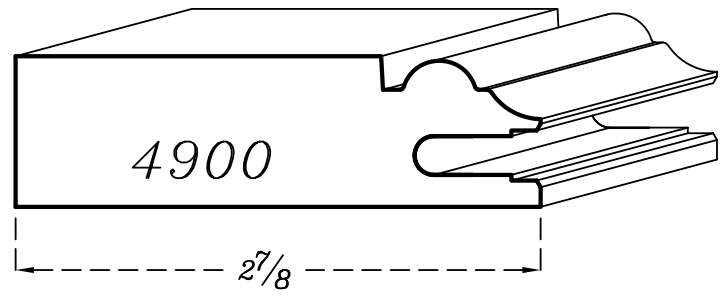

Profiles

Prestige series

Mitered door

Doors

Drawers

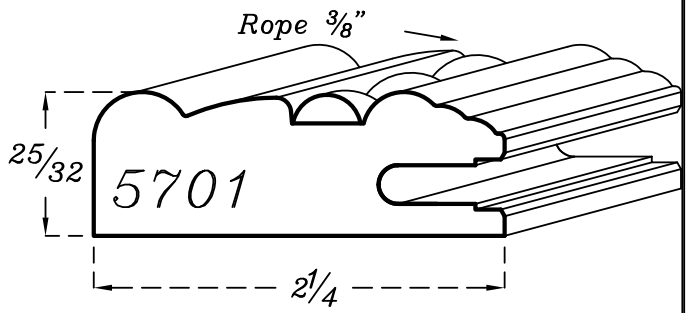
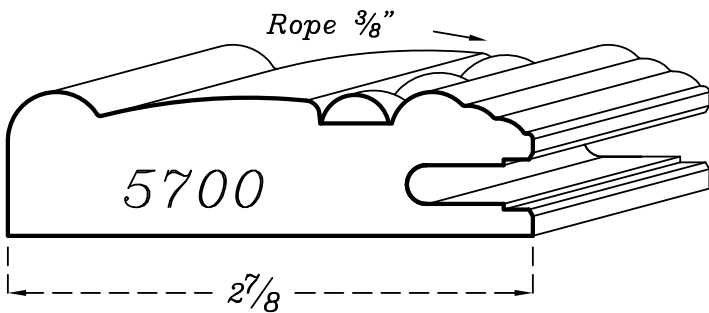
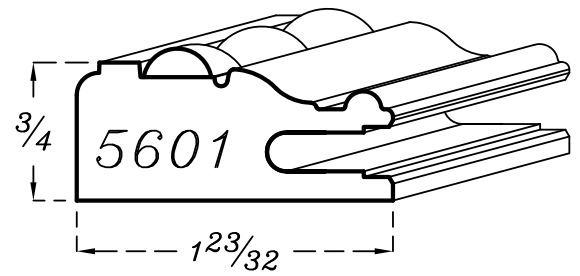
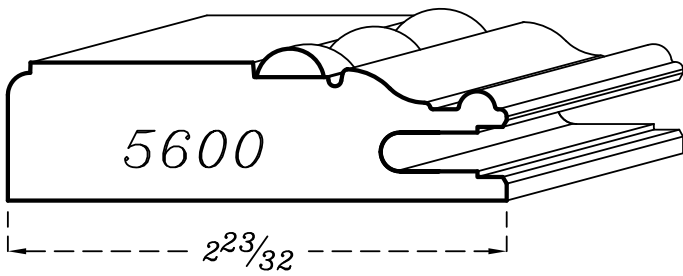
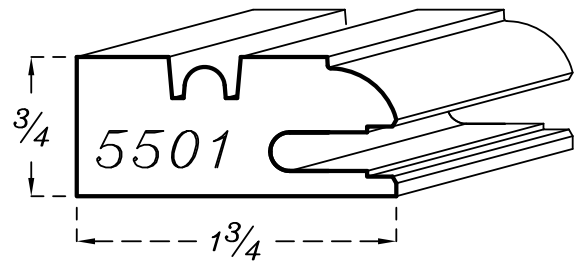
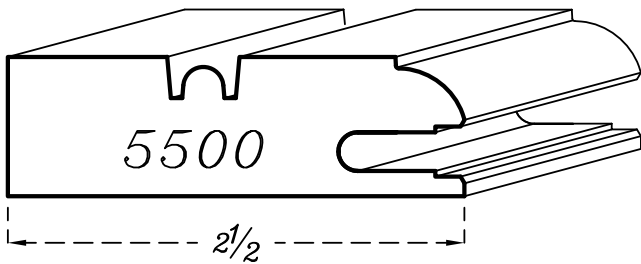
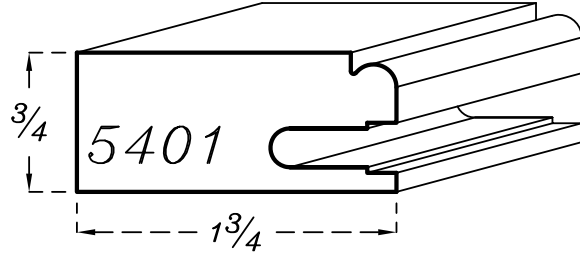
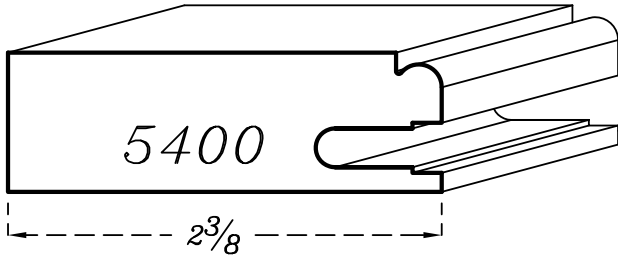

- 1 PROFILES
- 2 TRADITIONAL 90
- 3 DISTINCTIVE 90
- 4 CATHEDRAL 90
- 5 APPLIED MOULDINGS
- 6 PRESTIGE 45
- 7 WANSCOTS
- 8 SPECIALTY PRODUCTS
- 9 MOULDINGS
- 10 PROMOTIONAL ITEMS
- 11 POLICY

Profiles

Prestige series

Mitered door

Doors

Drawers

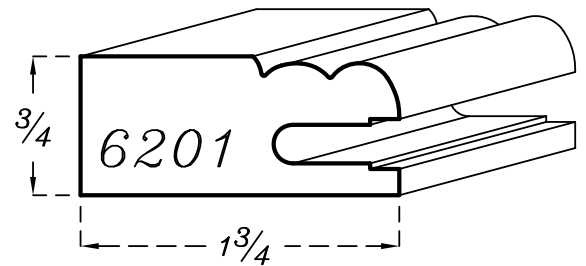
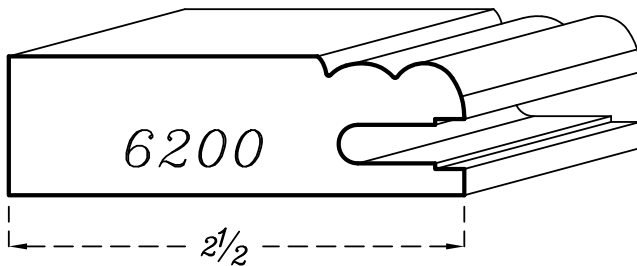
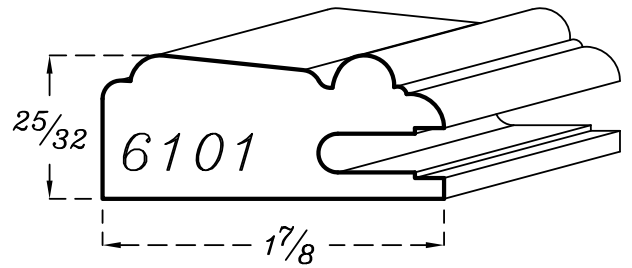
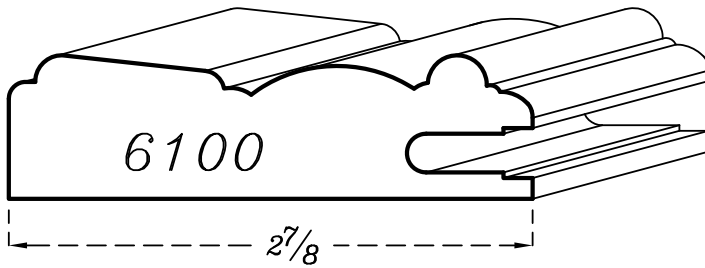
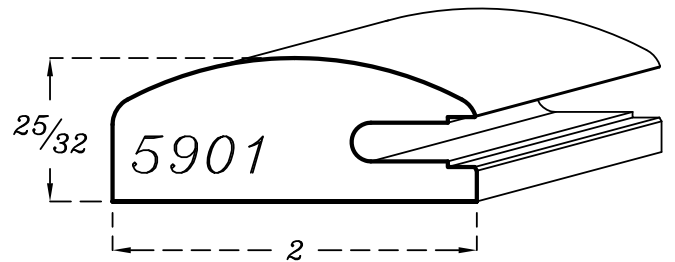
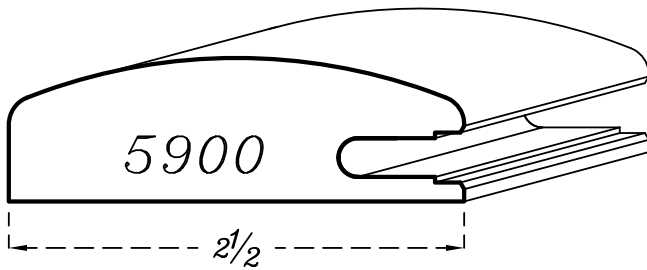
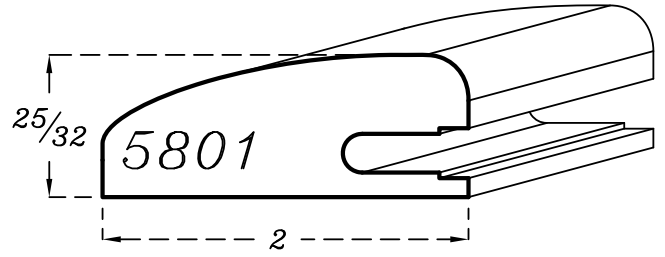
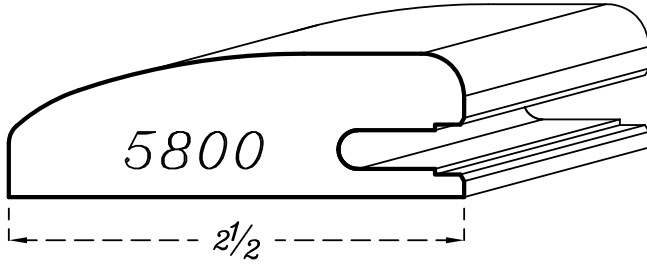

Profiles

Prestige series

Mitered door

Doors

Drawers

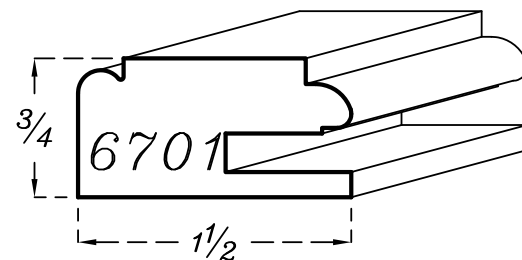
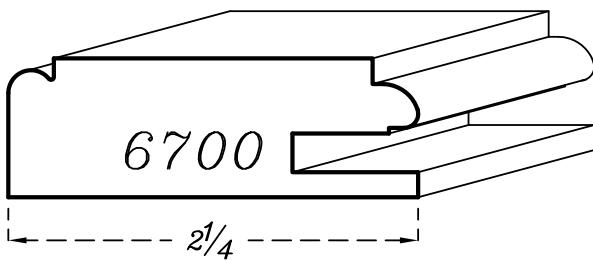
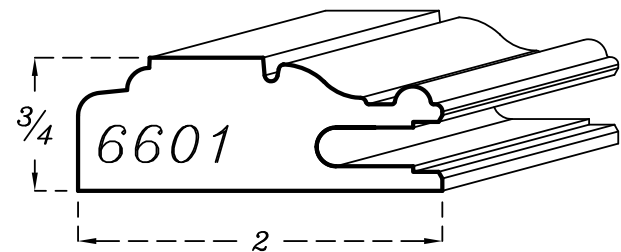
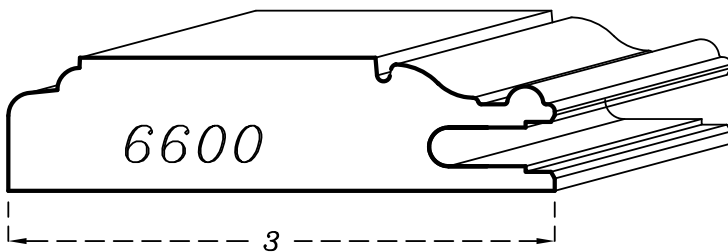
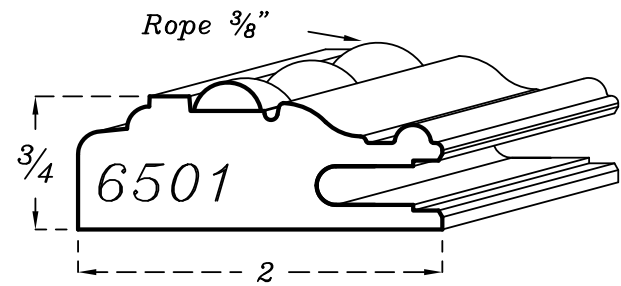
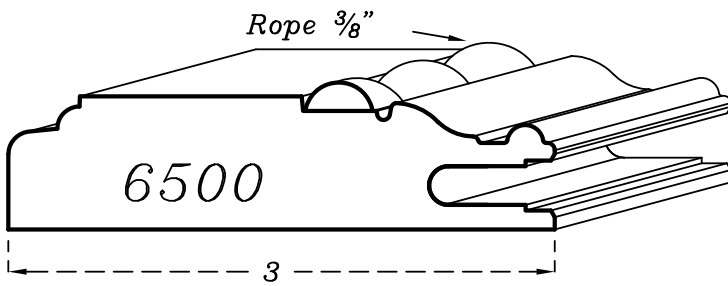
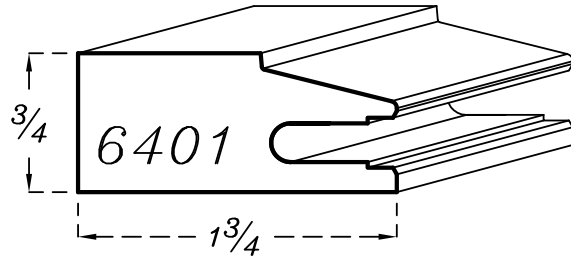
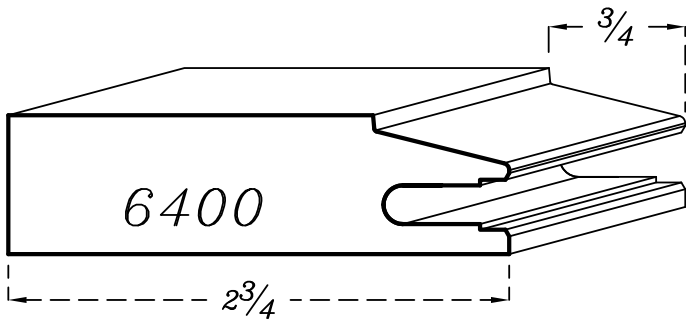

- 1 PROFILES
- 2 TRADITIONAL 90
- 3 DISTINCTIVE 90
- 4 CATHEDRAL 90
- 5 APPLIED MOULDINGS
- 6 PRESTIGE 45
- 7 WANNSCOTS
- 8 SPECIALTY PRODUCTS
- 9 MOULDINGS
- 10 PROMOTIONAL ITEMS
- 11 POLICY

Profiles

Prestige series

Mitered door

Doors

Drawers

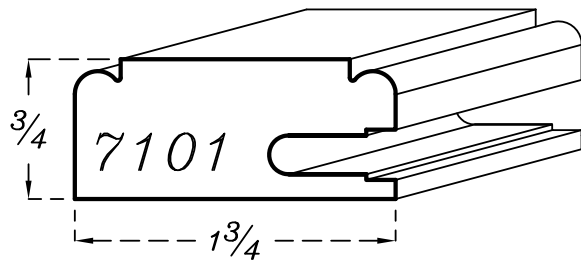
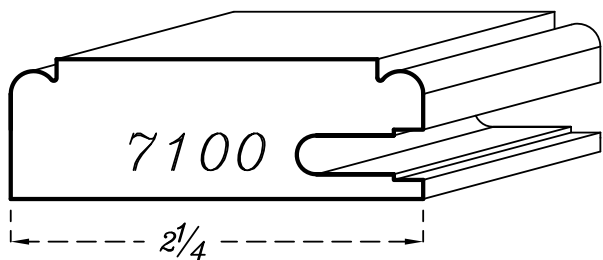
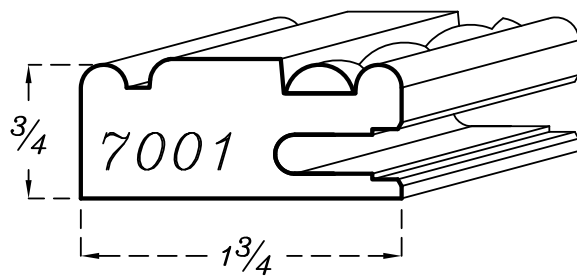
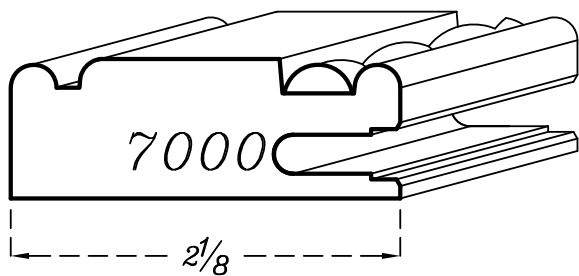
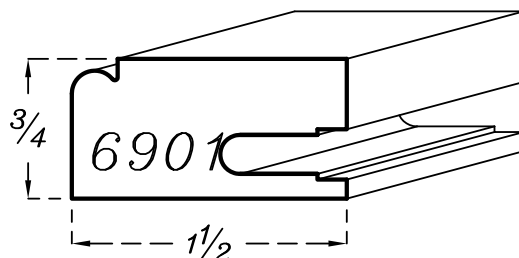
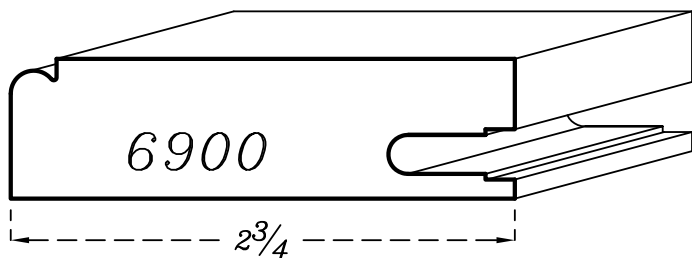
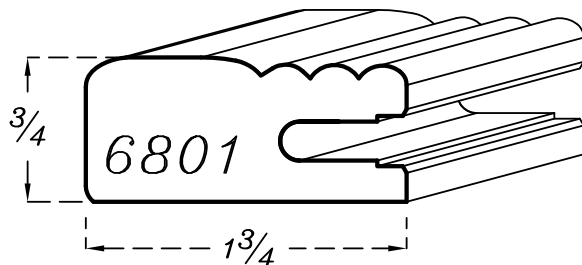
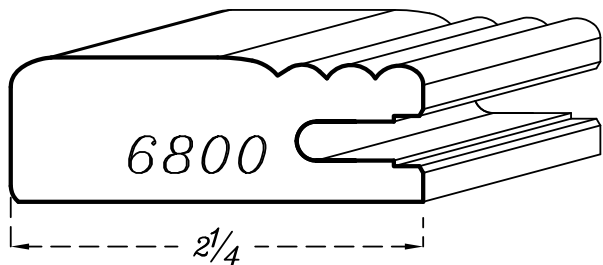

Profiles

Prestige series

Mitered door

Doors

Drawers

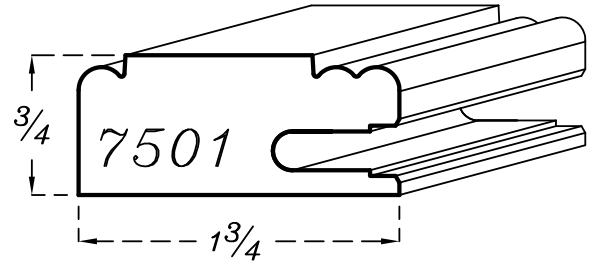
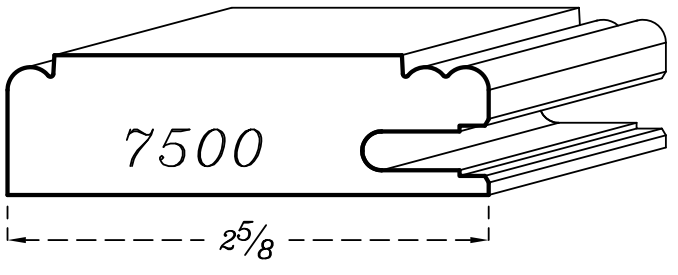
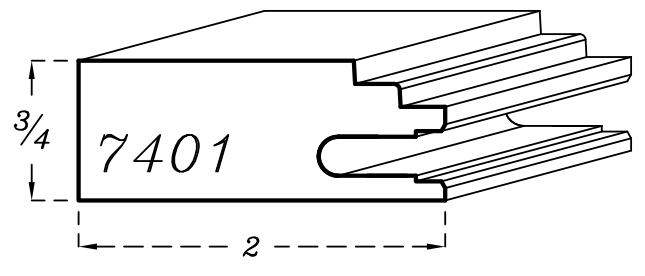
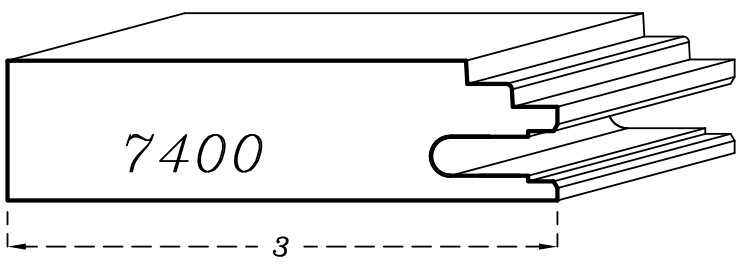
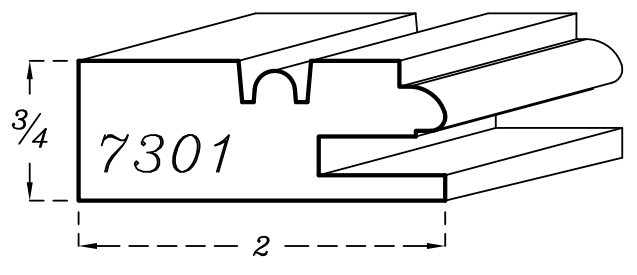
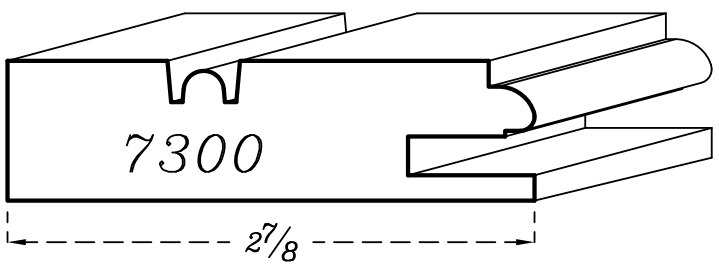
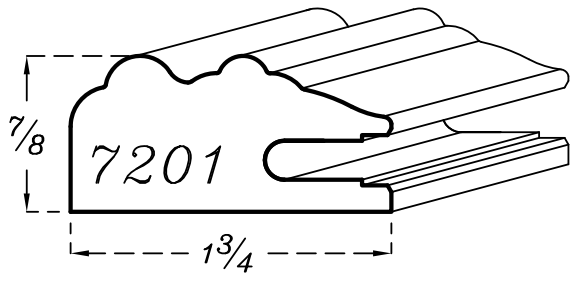
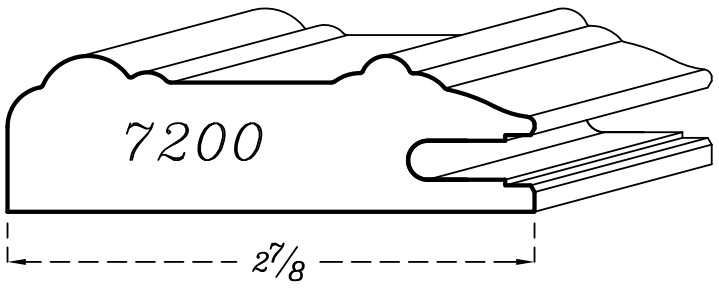

Profiles

Prestige series

Mitered door

Doors

Drawers

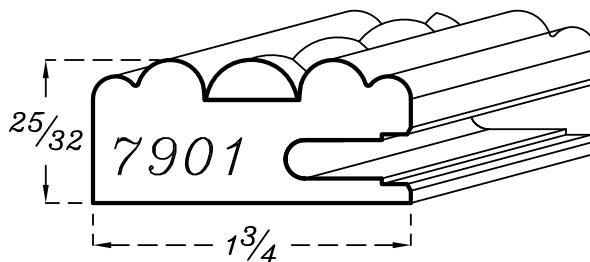
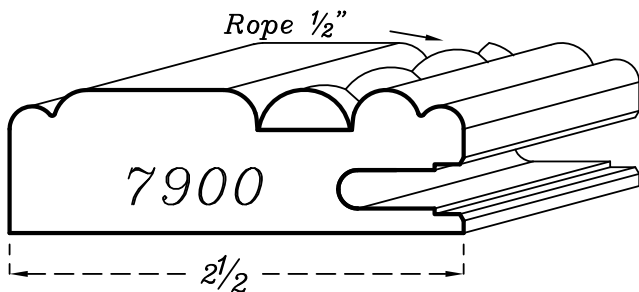
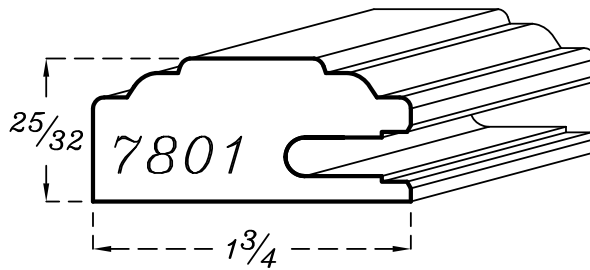
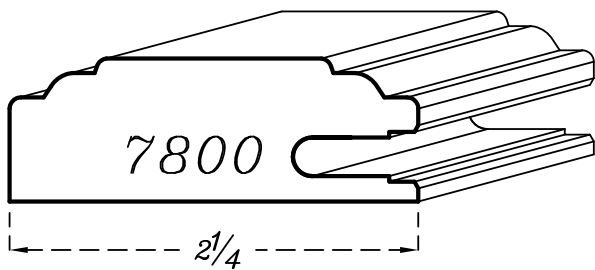
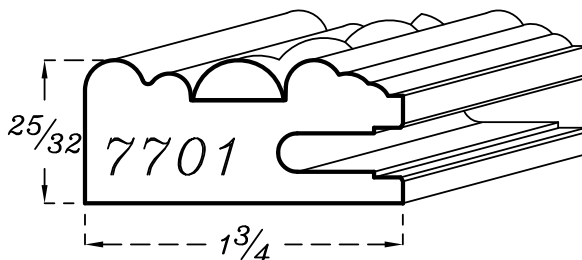
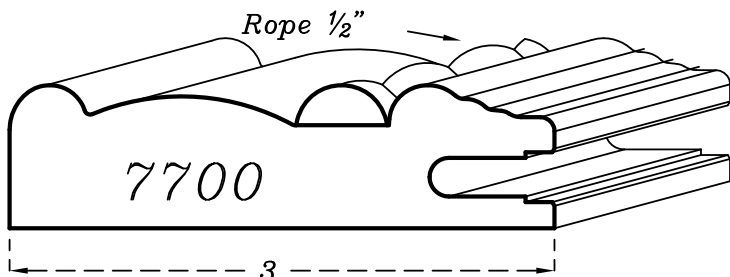
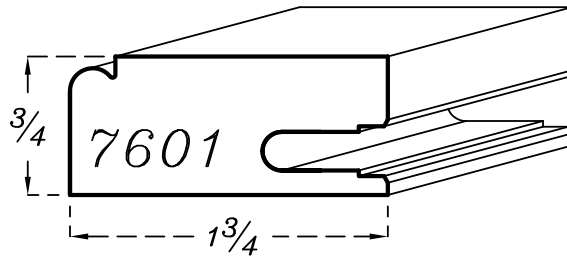
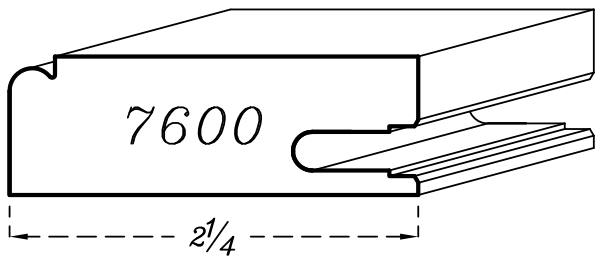

Profiles

Prestige series

Mitered door

Doors

Drawers

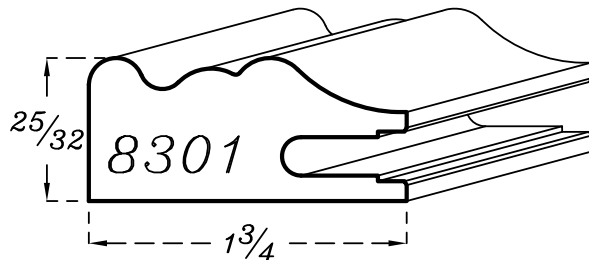
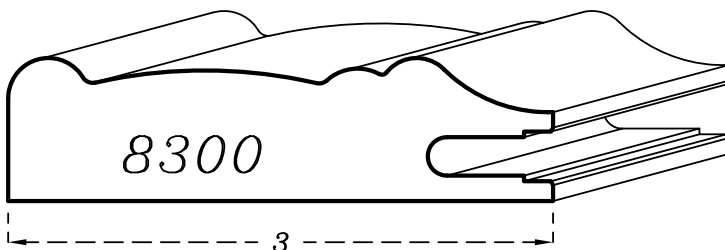
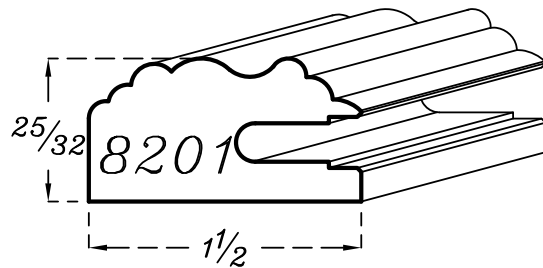
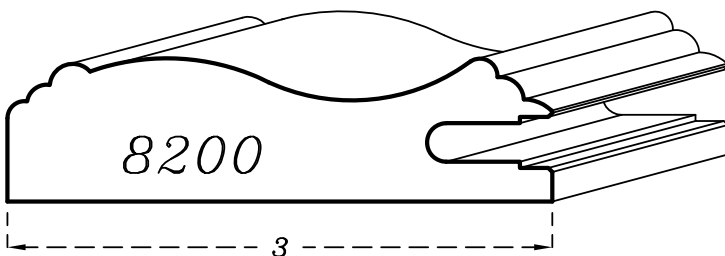
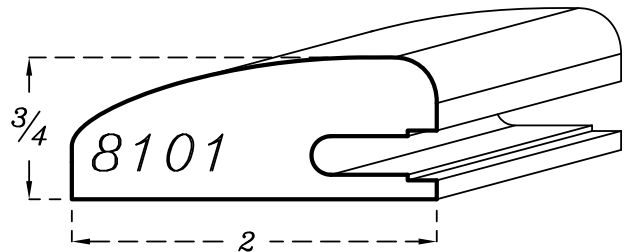
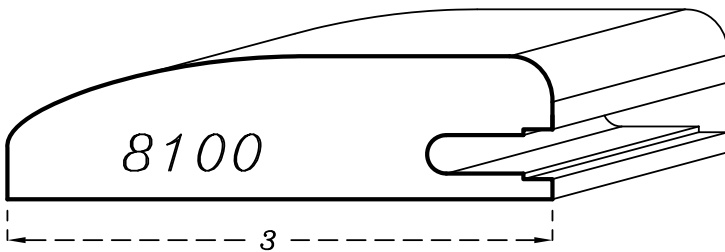
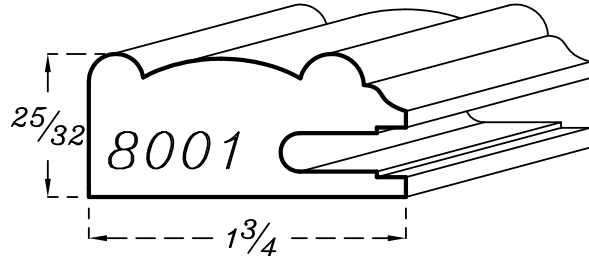
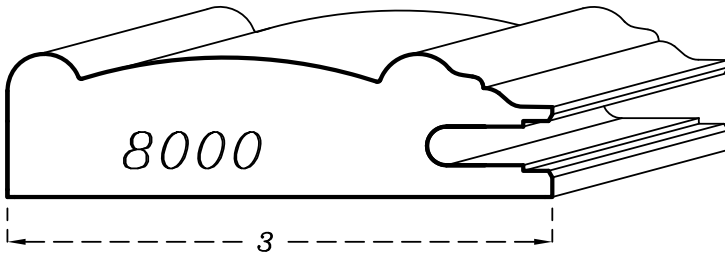

- 1 PROFILES
- 2 TRADITIONAL 90
- 3 DISTINCTIVE 90
- 4 CATHEDRAL 90
- 5 APPLIED MOULDINGS
- 6 PRESTIGE 45
- 7 WAINSCOTS
- 8 SPECIALTY PRODUCTS
- 9 MOULDINGS
- 10 PROMOTIONAL ITEMS
- 11 POLICY

Profiles

Prestige series

Mitered door

Doors

Drawers

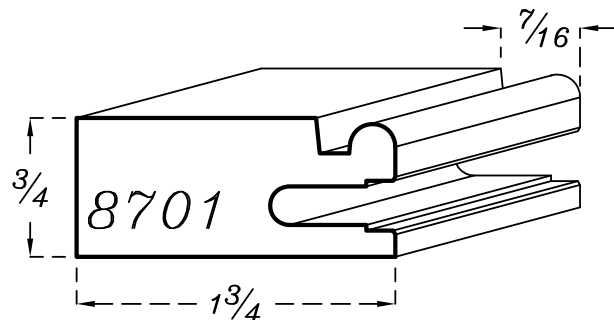
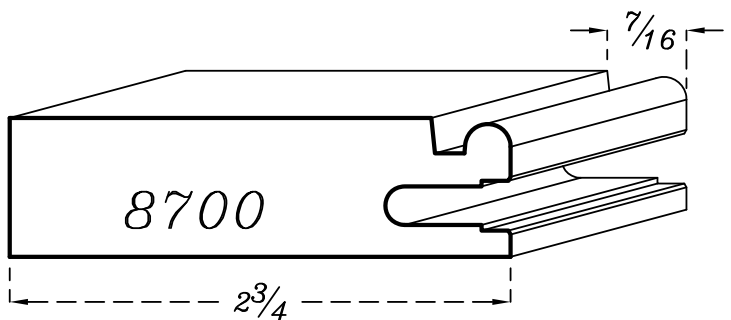
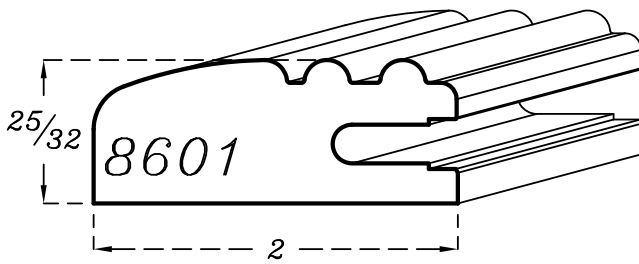
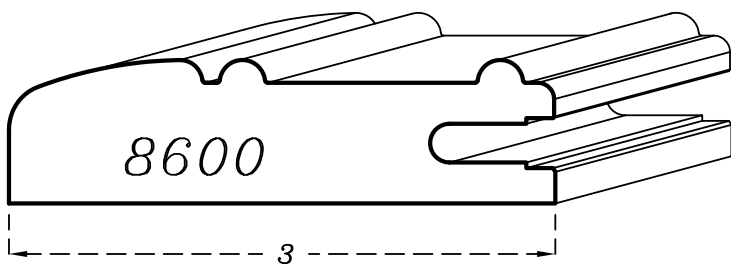
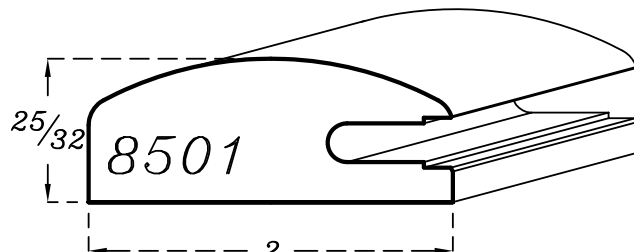
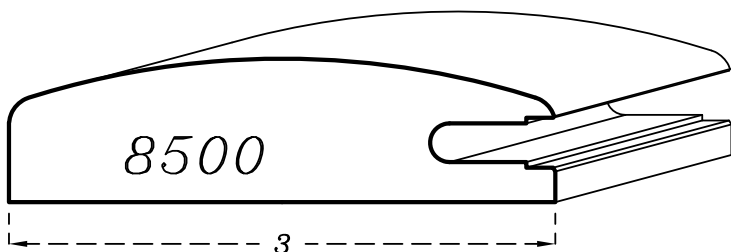
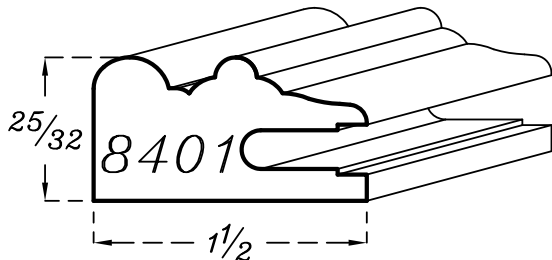
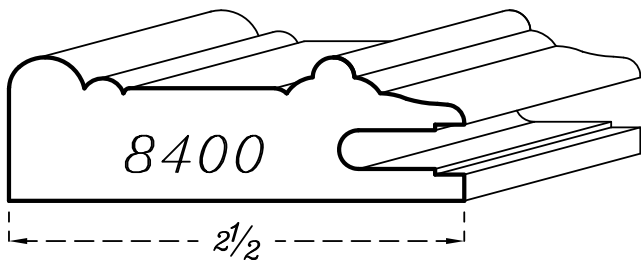

Profiles

Prestige series

Mitered door

Doors

Drawers

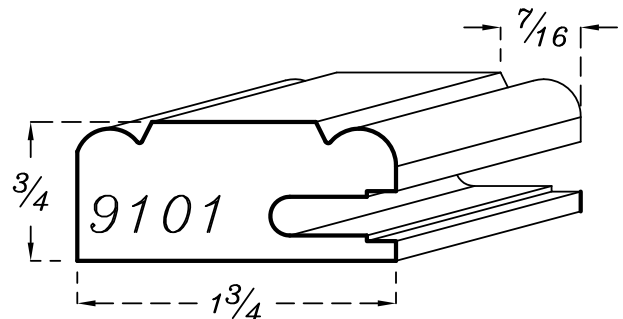
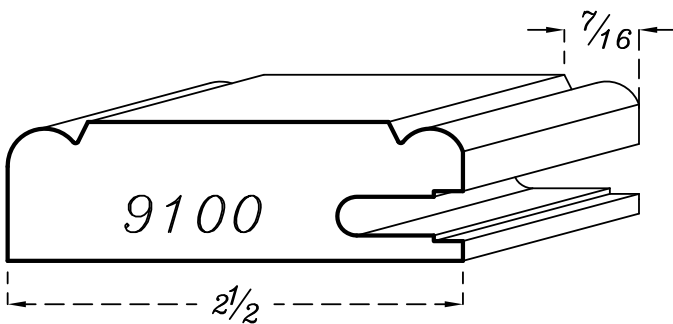
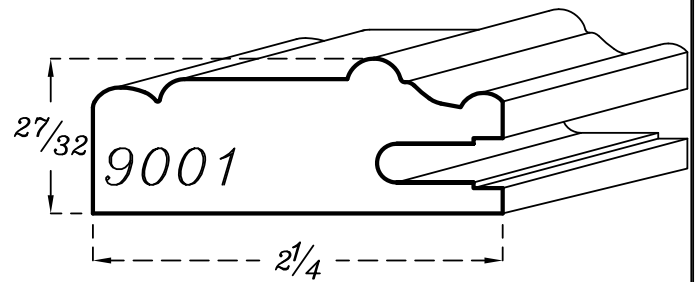
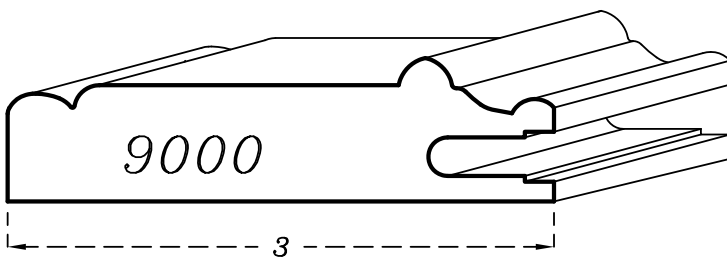
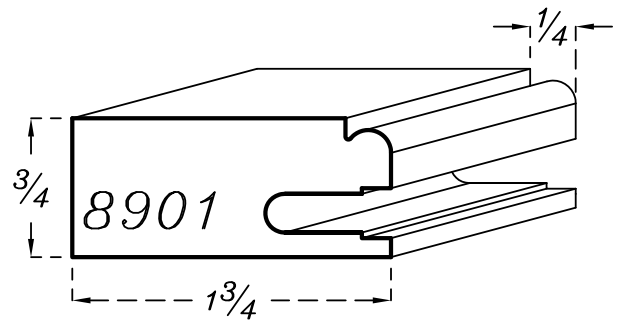
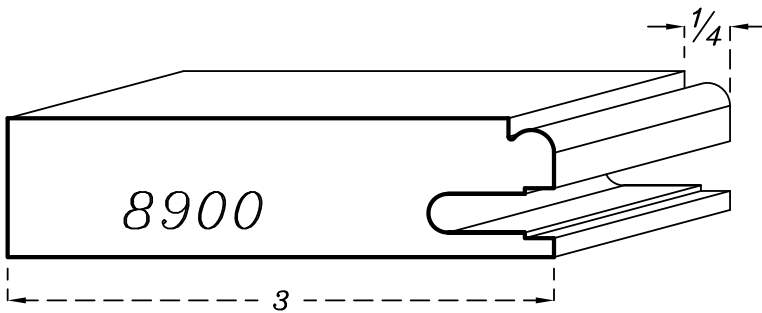
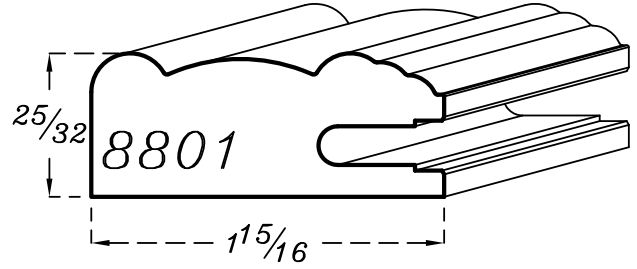
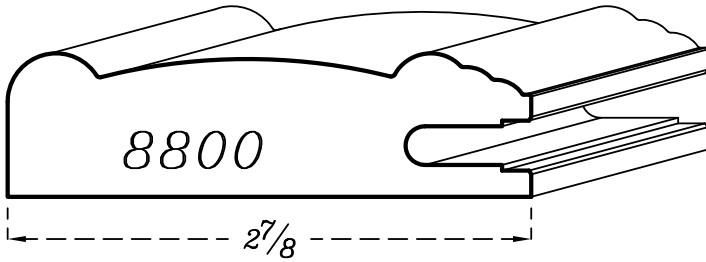

1
PROFILES

2
TRADITIONAL
90

3
DISTINCTIVE
90

4
CATHEDRAL
90

5
APPLIED
MOLDINGS

6
PRESTIGE
45

7
WANSCOTS

8
SPECIALTY
PRODUCTS

9
MOLDINGS

10
PROMOTIONAL
ITEMS

11
POLICY

Profiles

Prestige series

Mitered door

Doors

Drawers

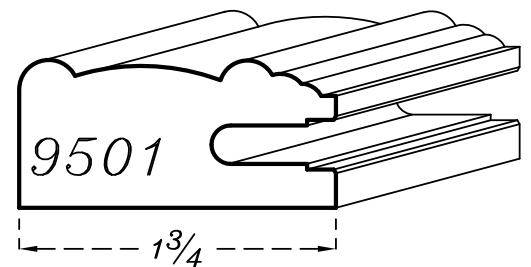
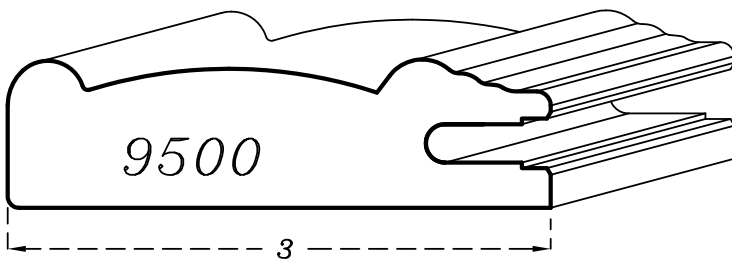
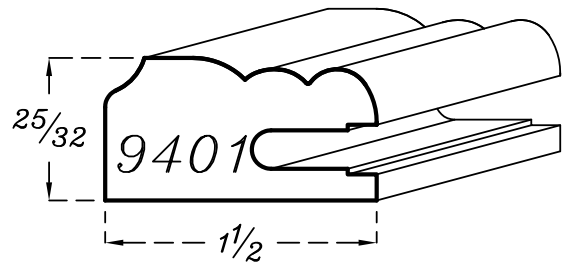
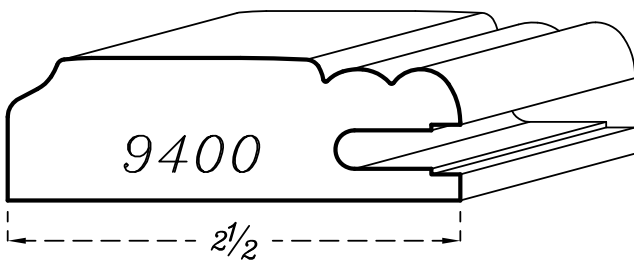
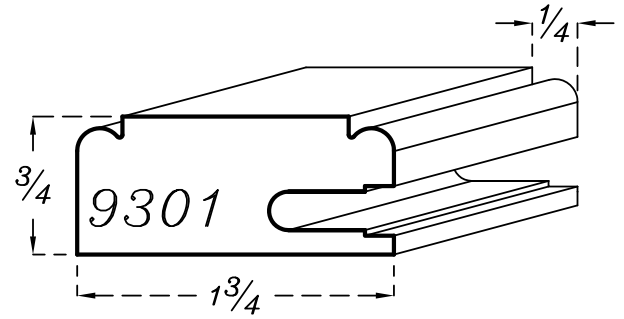
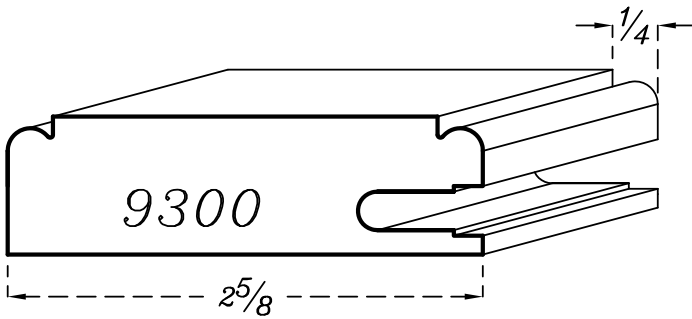
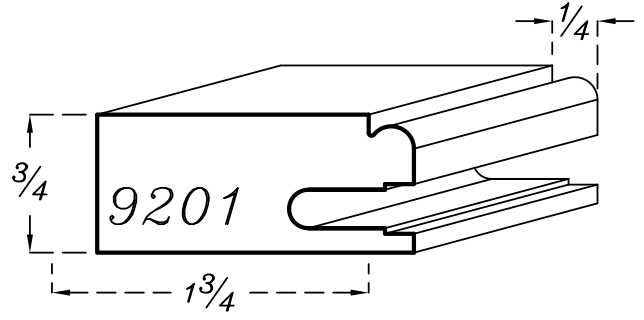
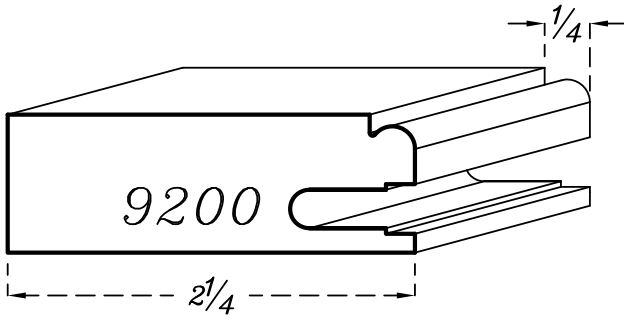

Profiles

Prestige series

Mitered door

Doors

Drawers

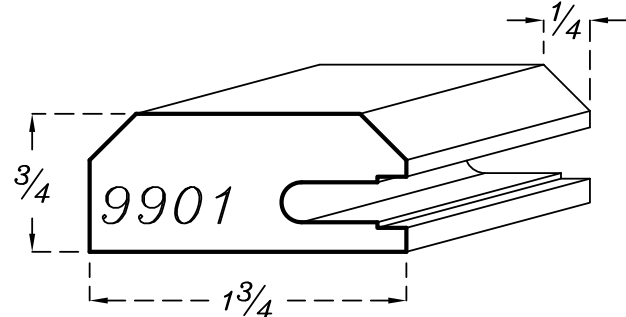
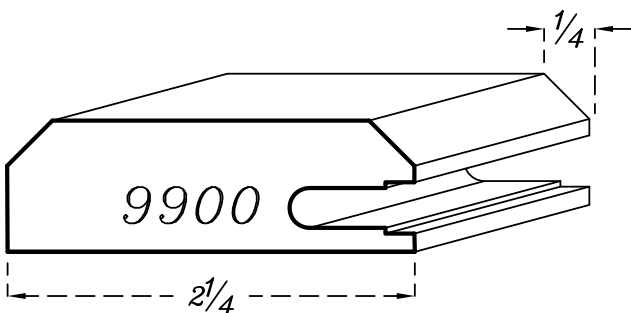
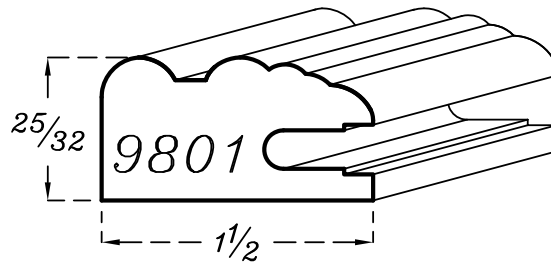
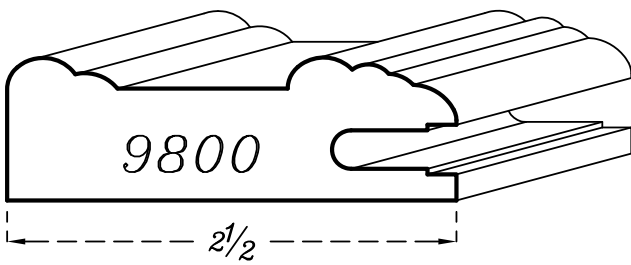
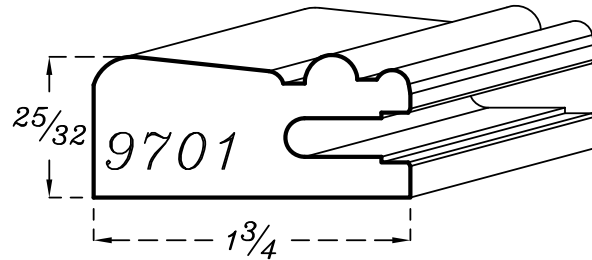
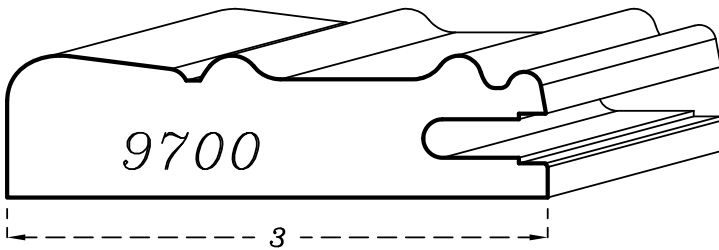
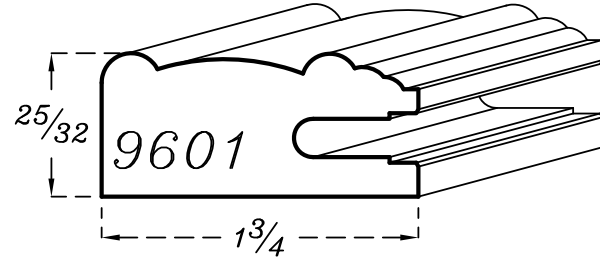
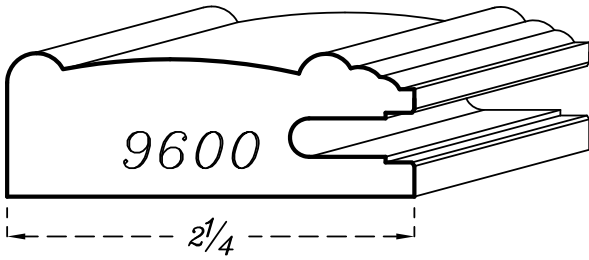

- 1 PROFILES
- 2 TRADITIONAL 90
- 3 DISTINCTIVE 90
- 4 CATHEDRAL 90
- 5 APPLIED MOULDINGS
- 6 PRESTIGE 45
- 7 WANNSCOTS
- 8 SPECIALTY PRODUCTS
- 9 MOULDINGS
- 10 PROMOTIONAL ITEMS
- 11 POLICY

Slab drawer options

Prestige series

SLAB DRAWER FRONT: # 51/?

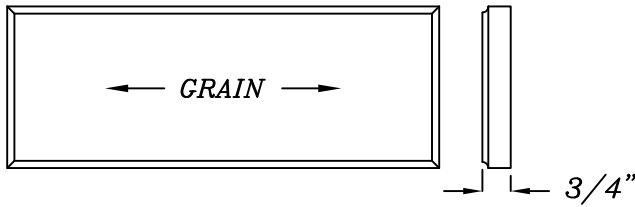

Slab 3/4" thick with edge profile framing bead and center panel profile

OPTIONS

?	Edge profiles	E-01 to E-48; EP-01 to EP-53
---	---------------	------------------------------

SLAB DRAWER FRONT: # 54/?

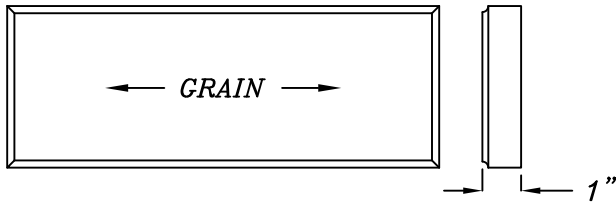

Slab 1" thick with edge profile framing bead and center panel profile

OPTIONS

?	Edge profiles	E-01 to E-58; EP-01 to EP-53
---	---------------	------------------------------

Glass dimension

Glass width

$$\textcircled{L} - (\textcircled{A} + \textcircled{B}) + 11/16 = \text{glass width}$$

$$\text{EX: } 12 - (2 \frac{1}{4} + 2 \frac{1}{4}) + 11/16 = 8 \frac{3}{16}$$

Glass height

$$\textcircled{H} - (\textcircled{C} + \textcircled{D}) + 11/16 = \text{glass height}$$

$$\text{EX: } 24 - (2 \frac{1}{4} + 2 \frac{1}{4}) + 11/16 = 20 \frac{3}{16}$$

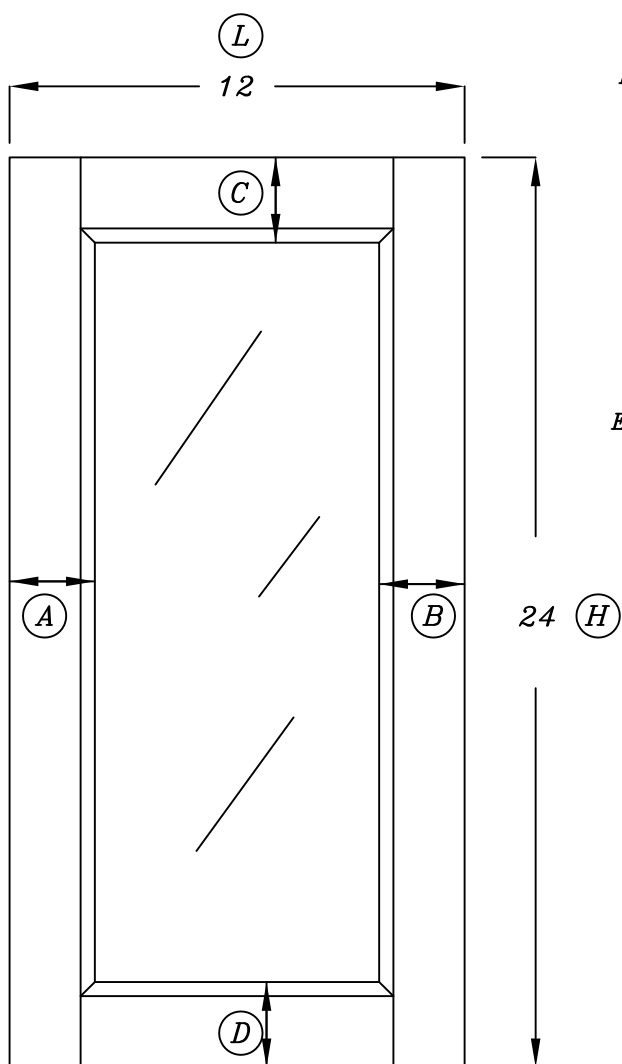

This calculation
leaves a tolerance
between
 $\frac{1}{16}$ " and $\frac{1}{8}$ "

Frames Options

Prestige series

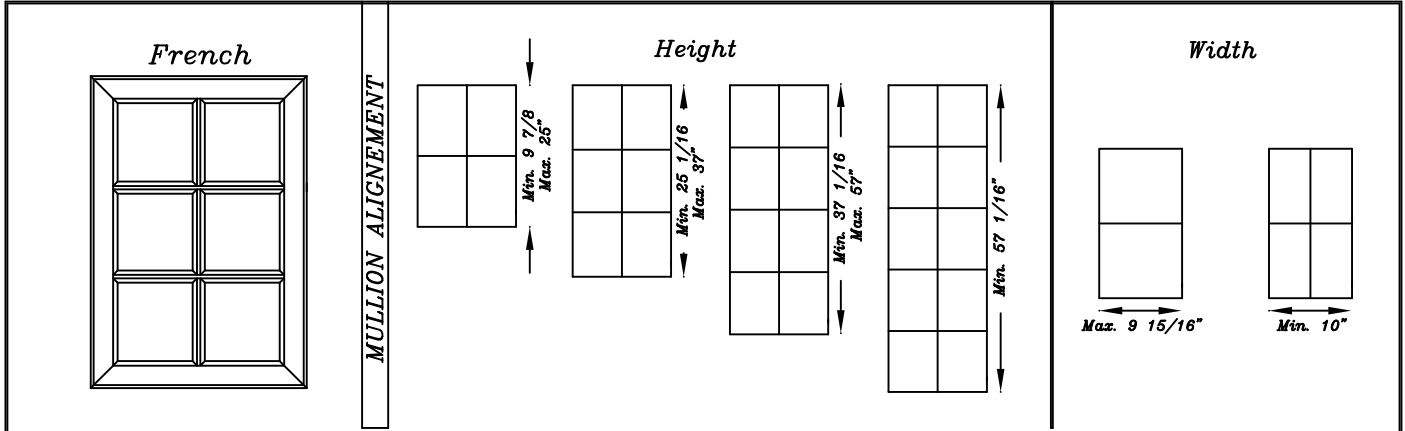

OPTIONS

?	Amount of tiles	0/2/3/4/6/8/9/10
---	-----------------	------------------

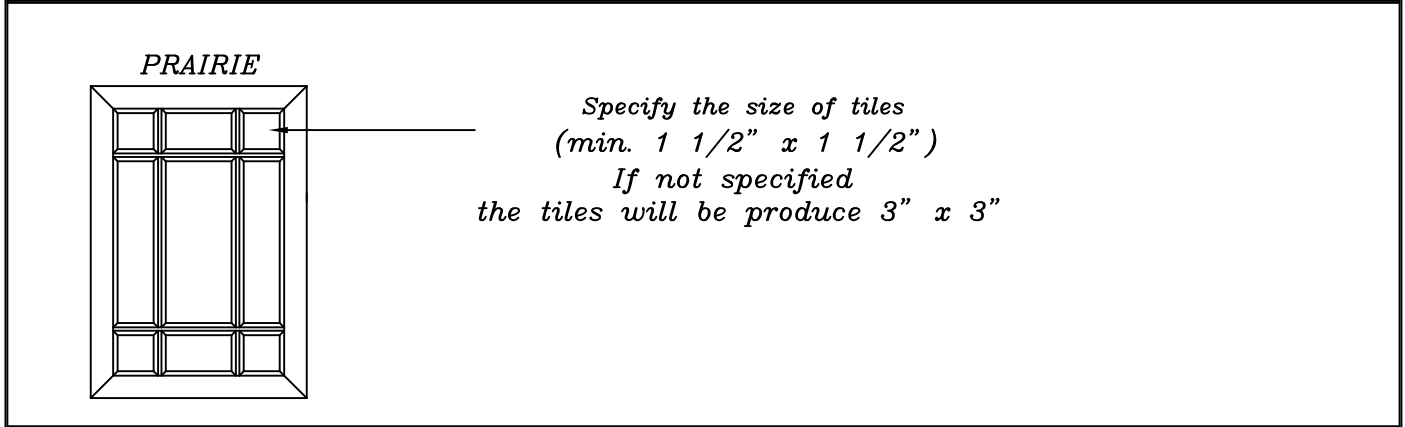

Doors

Prestige series

DOOR # 3700/?

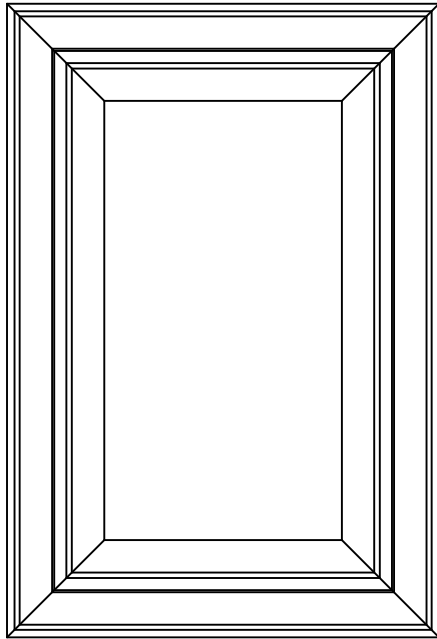

Minimum height and Width (solid) = 7"
Minimum height and width (veneer) = 6"

FRAME # 3705/?

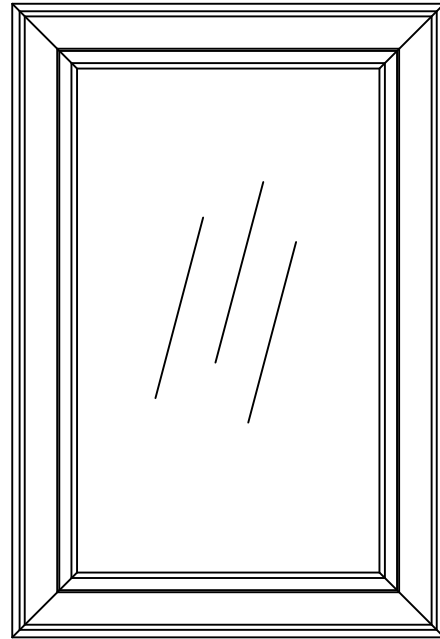

Minimum height and width = 6"

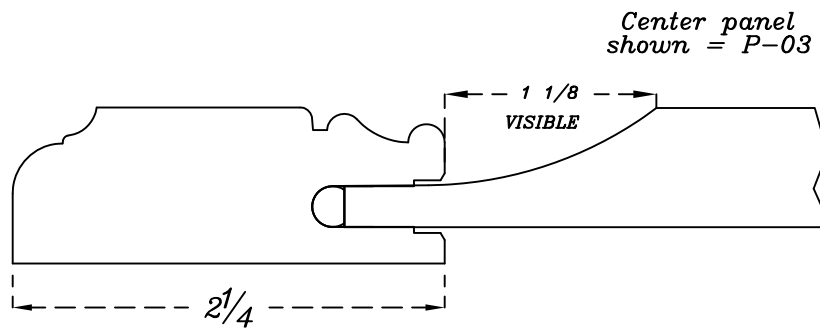

Center panel shown = P-03

Mullion model

AM32

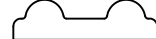

5-PIECE DRAWER FRONT: # 3701/?

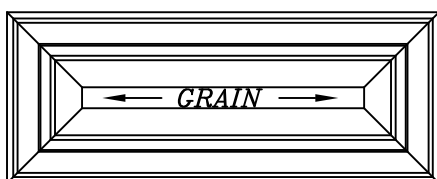

Minimum height and width available = 6 3/4"
(With a visible of 1/8")

Rails and stiles = 2"

Mitered drawer front matches framing bead and center panel profile

- 1 PROFILES
- 2 TRADITIONAL 90
- 3 DISTINCTIVE 90
- 4 CATHEDRAL 90
- 5 APPLIED MOULDINGS
- 6 PRESTIGE 45
- 7 WANSCOTS
- 8 SPECIALTY PRODUCTS
- 9 MOULDINGS
- 10 PROMOTIONAL ITEMS
- 11 POLICY

Doors

Prestige series

DOOR # 3800/?

FRAME # 3805/?

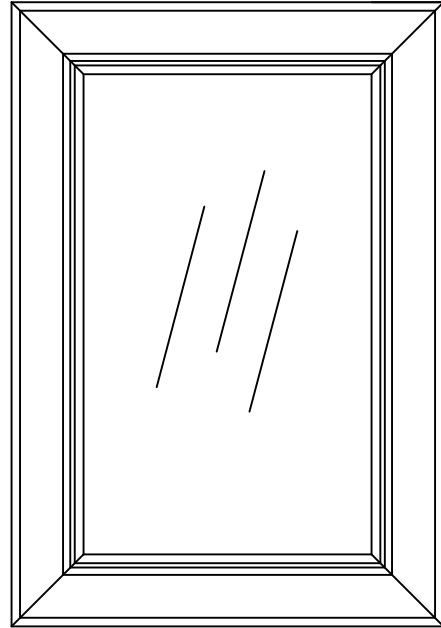
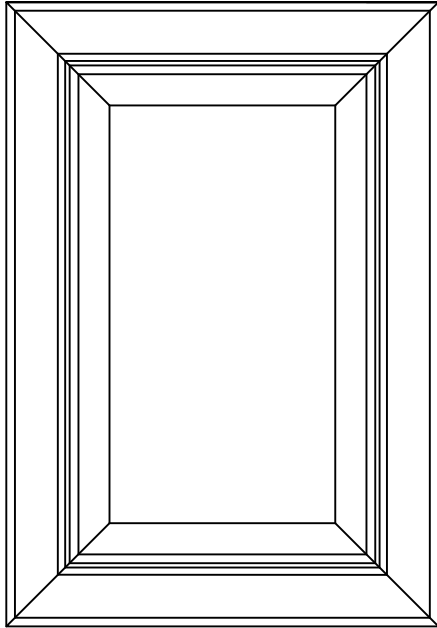

Minimum height and Width (solid) = 8 1/2"
Minimum height and width (veneer) = 7 1/2"

Minimum height and width = 7 1/2"

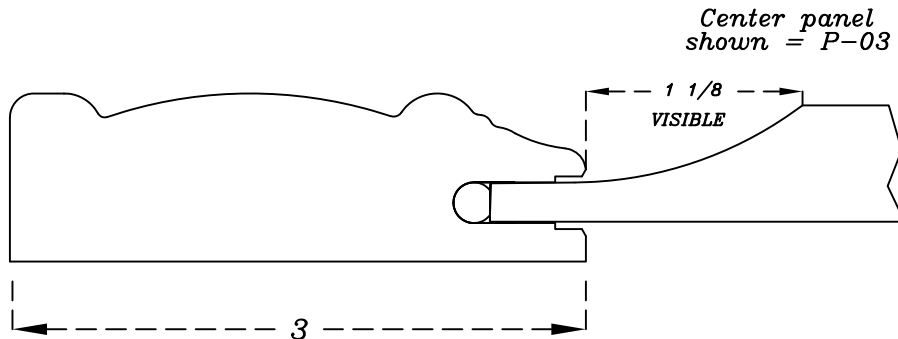

Mullion frame non-available

5-PIECES DRAWER FRONT: # 3801/?

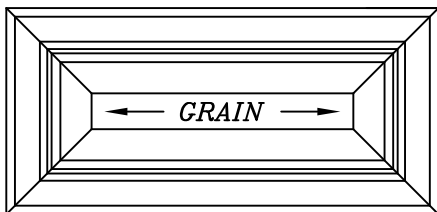

Minimum height and width available = 6 3/4"
(With a visible of 1/8")

Rails and stiles 2"

Mitered drawer front
Match corresponding door's edge profile,
framing bead and center panel profile

Doors

Prestige series

- 1 PROFILES
- 2 TRADITIONAL 90
- 3 DISTINCTIVE 90
- 4 CATHEDRAL 90
- 5 APPLIED MOULDINGS
- 6 PRESTIGE 45
- 7 WANSCOTS
- 8 SPECIALTY PRODUCTS
- 9 MOULDINGS
- 10 PROMOTIONAL ITEMS
- 11 POLICY

DOOR # 3900/?

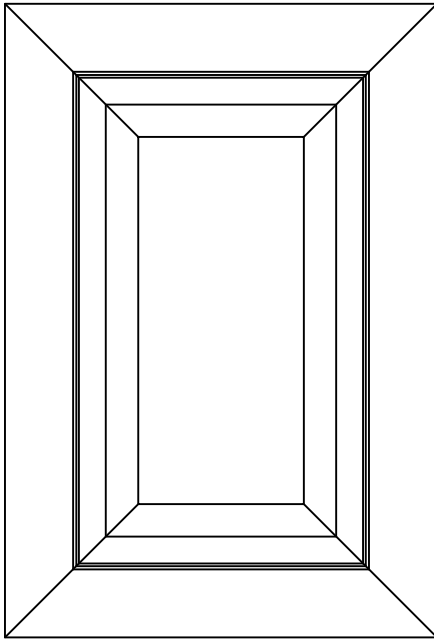

Minimum height and Width (solid) = 9 1/2"
Minimum height and width (veneer) = 8 1/2"

FRAME # 3905/?

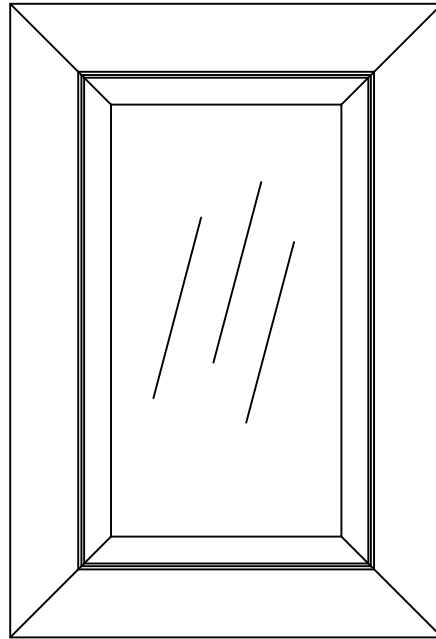

Minimum height and width = 8 1/2"

Center panel shown = P-03

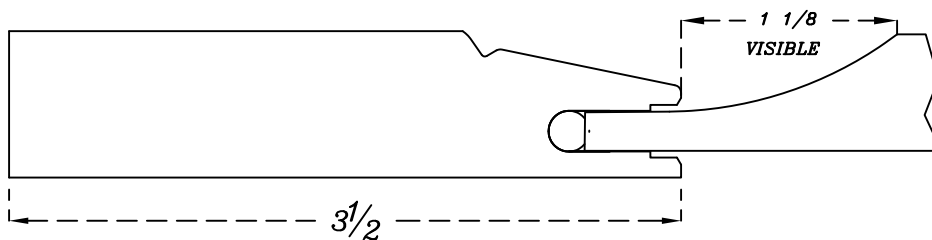

Mullion frame non-available

5-PIECES DRAWER FRONT: # 3901/?

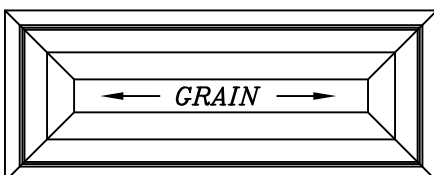

Minimum height and width available = 6 1/4"
(With a visible of 1/8")

Rails and stiles 1 3/4"

Mitered drawer front
Match corresponding door's edge profile, framing bead and center panel profile

Doors

Prestige series

DOOR # 4000/???

FRAME # 4005/???

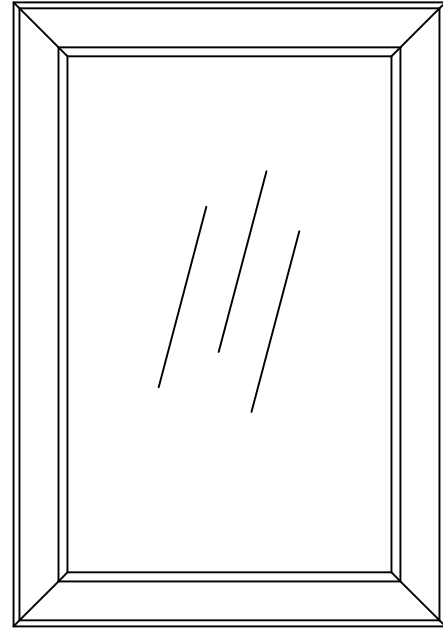
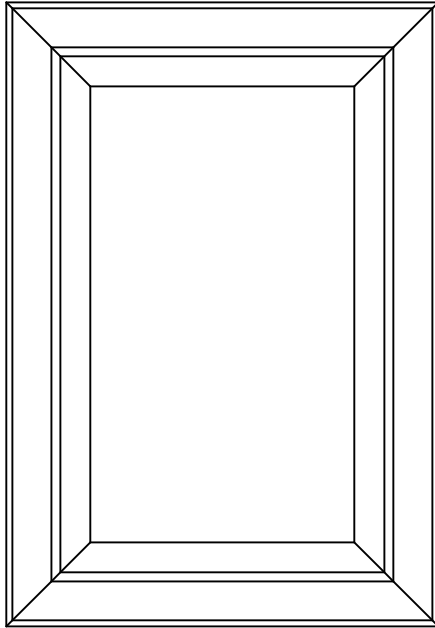

Minimum height and Width (solid) = 9 3/4"
Minimum height and width (veneer) = 8 3/4"

Width and Height minimum = 8 3/4"

Edge profile shown = E-04

Framing beads shown = A

Center panel shown = P-03

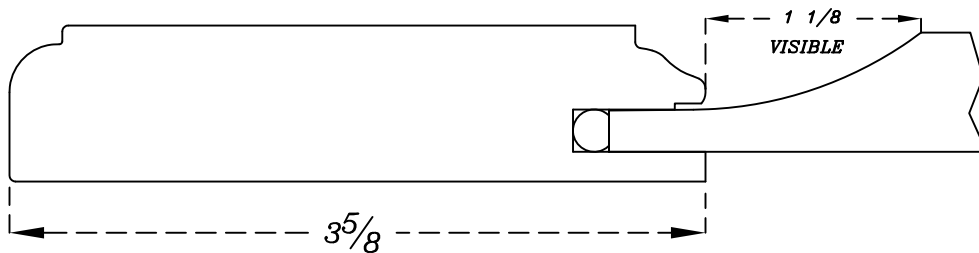

All framing beads of standard doors available

5-PIECES DRAWER FRONT: # 4001/???

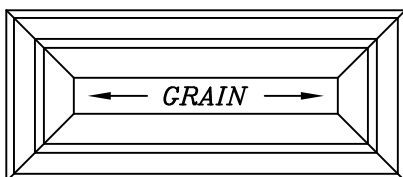

Rails and stiles 1 11/16"

Minimum height and width available = 6 1/8"
(With a visible of 1/8")

Mitered drawer front
Match corresponding door's edge profile,
framing bead and center panel profile

Doors

Prestige series

- 1 PROFILES
- 2 TRADITIONAL 90
- 3 DISTINCTIVE 90
- 4 CATHEDRAL 90
- 5 APPLIED MOULDINGS
- 6 PRESTIGE 45
- 7 WANSCOTS
- 8 SPECIALTY PRODUCTS
- 9 MOULDINGS
- 10 PROMOTIONAL ITEMS
- 11 POLICY

DOOR # 4200/?

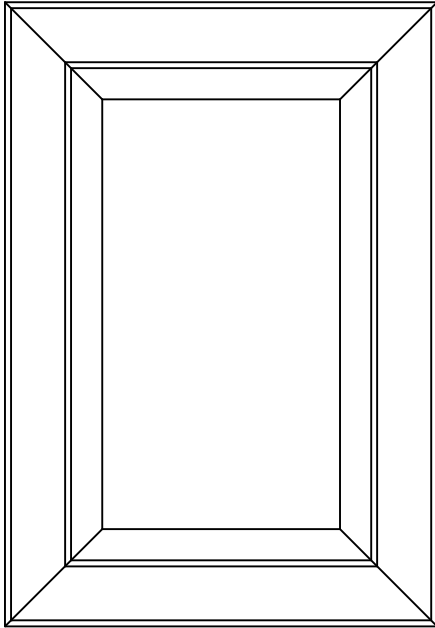

*Minimum height and Width (solid) = 7"
Minimum height and width (veneer) = 6"*

FRAME # 4205/?

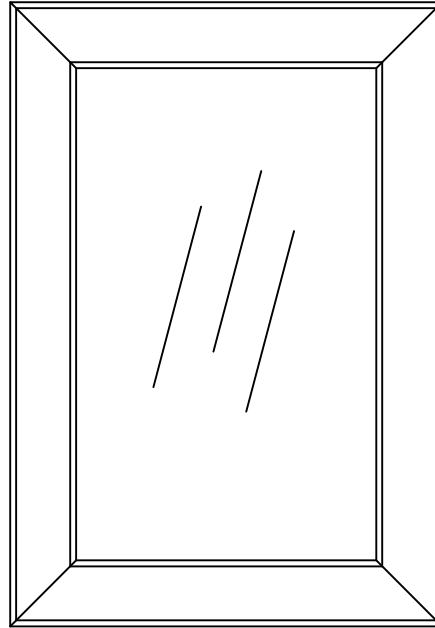

Minimum height and width = 6"

Center panel shown = P-03

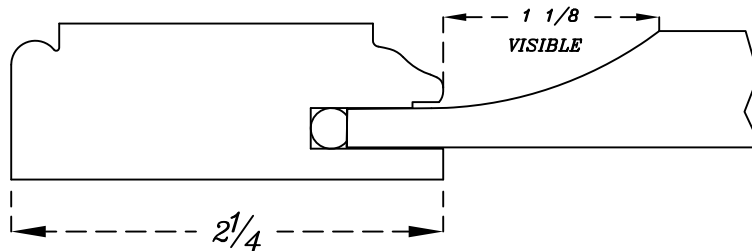

Mullion model

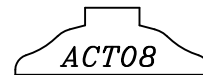

5-PIECES DRAWER FRONT: # 4201/?

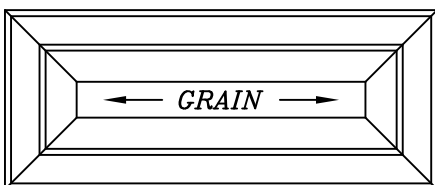

*Minimum height and width available = 6 1/4"
(With a visible of 1/8")*

Rails and stiles 1 7/8"

*Mitered drawer front
Match corresponding door's edge profile,
framing bead and center panel profile*

Doors

Prestige series

DOOR # 4300/?

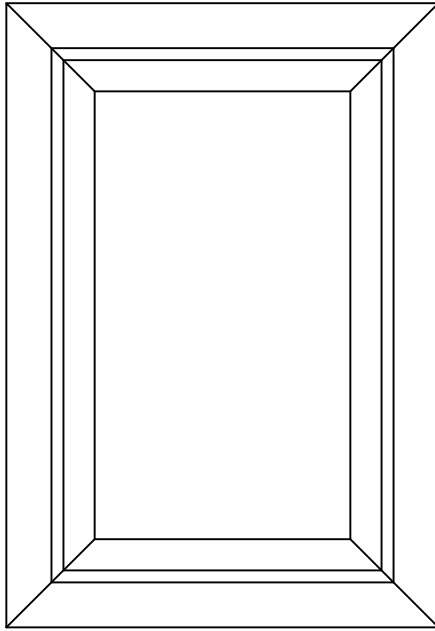

Minimum height and Width (solid) = 7 3/4"
 Minimum height and width (veneer) = 6 3/4"

FRAME # 4305/?

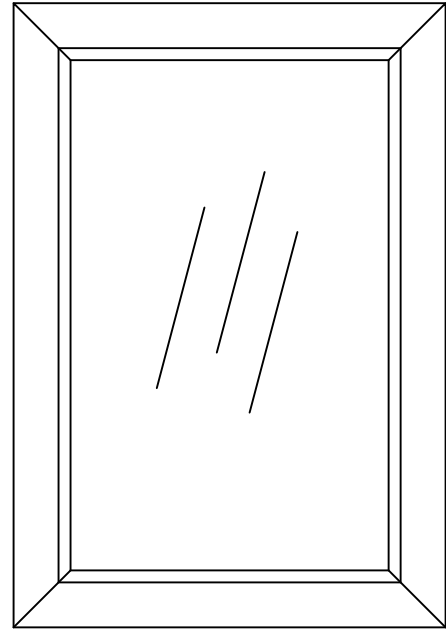

Minimum height and width = 6 3/4"

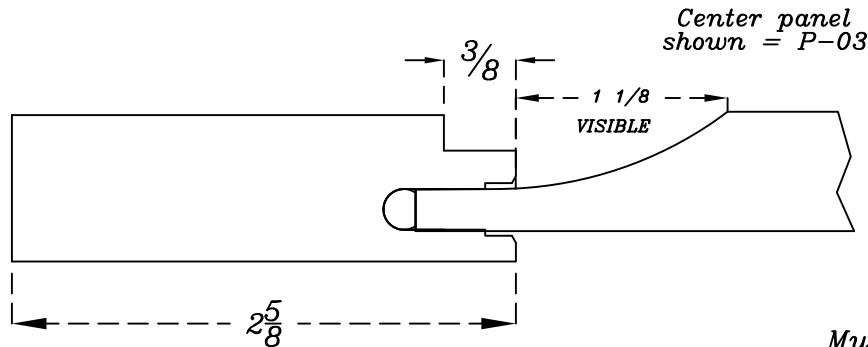

Mullion model

M011

5-PIECE DRAWER FRONT: # 4301/?

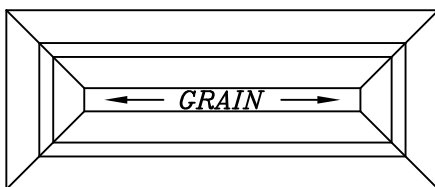

Minimum height and width available = 6 1/8"
 (With a visible of 1/8")

Standard rails and stiles 1 11/16"
 Optional rails and stiles 2"

If the option 2" is not specified
 front will be produced to 1 11/16"

Mitered drawer front matches
 framing bead and center panel profile

Doors

Prestige series

- 1 PROFILES
- 2 TRADITIONAL 90
- 3 DISTINCTIVE 90
- 4 CATHEDRAL 90
- 5 APPLIED MOULDINGS
- 6 PRESTIGE 45
- 7 WANSCOTS
- 8 SPECIALTY PRODUCTS
- 9 MOULDINGS
- 10 PROMOTIONAL ITEMS
- 11 POLICY

DOOR # 4400/?

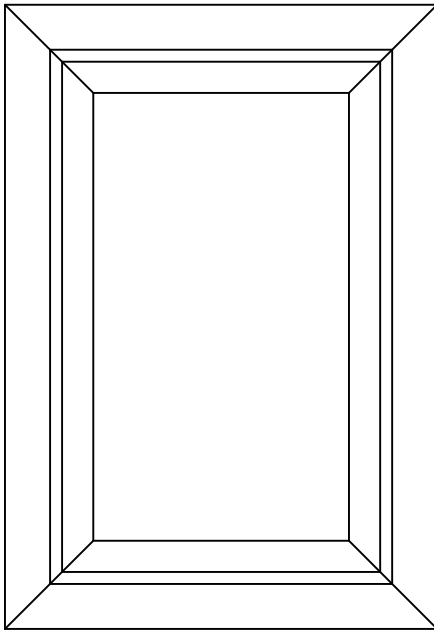

Minimum height and Width (solid) = 7 3/4"
Minimum height and width (veneer) = 6 3/4"

FRAME # 4405/?

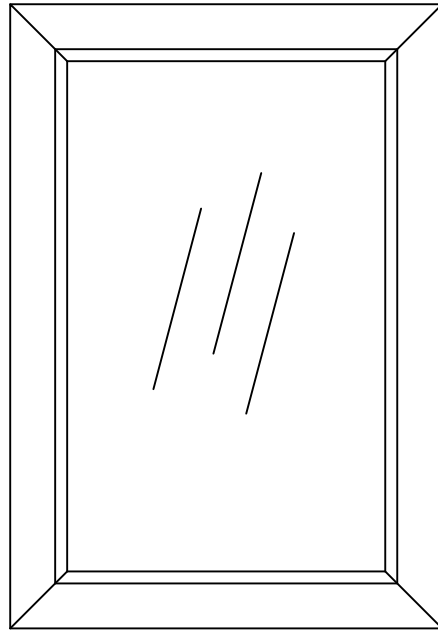

Minimum height and width = 6 3/4"

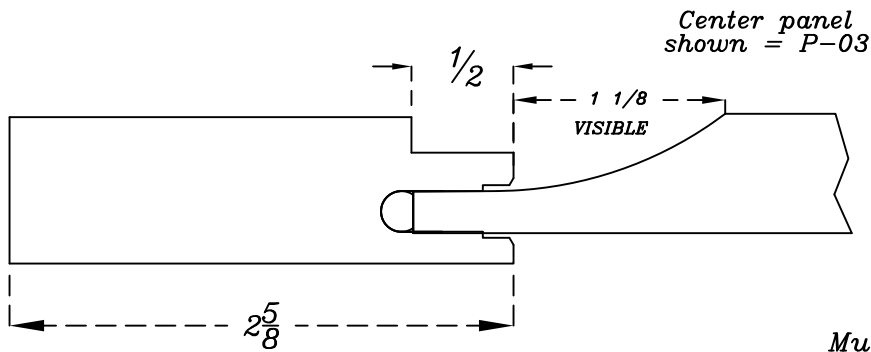

Mullion model

M011

5-PIECES DRAWER FRONT: # 4401/?

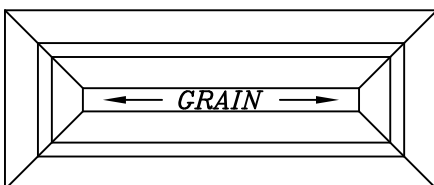

Minimum height and width available = 6 1/8"
(With a visible of 1/8")

Rails and stiles = 1 11/16"

Mitered drawer front
Match corresponding door's edge profile, framing bead and center panel profile

Doors

Prestige series

DOOR # 4500/?

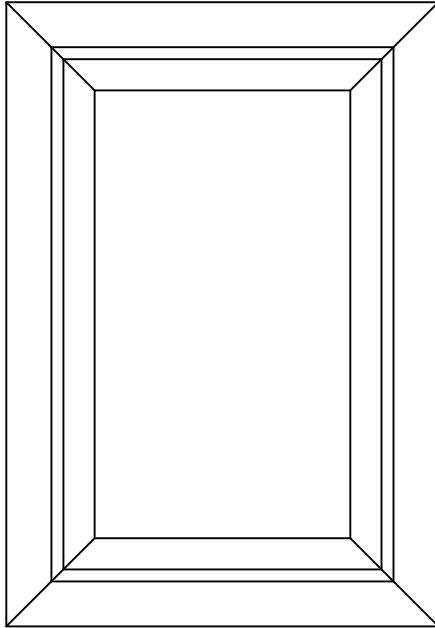

Minimum height and Width (solid) = 7 1/4"
 Minimum height and width (veneer) = 6 1/4"

FRAME # 4505/?

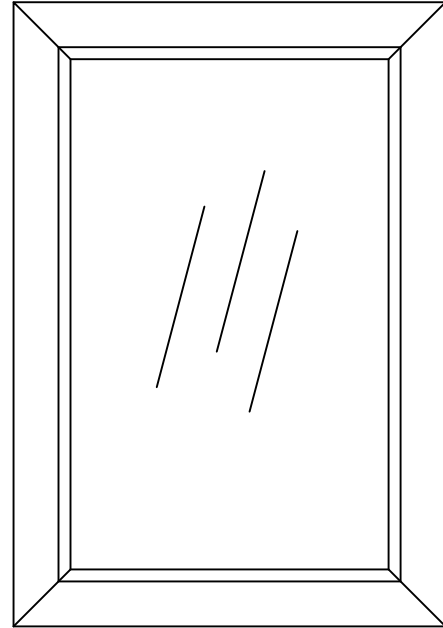

Minimum height and width = 6 1/4"

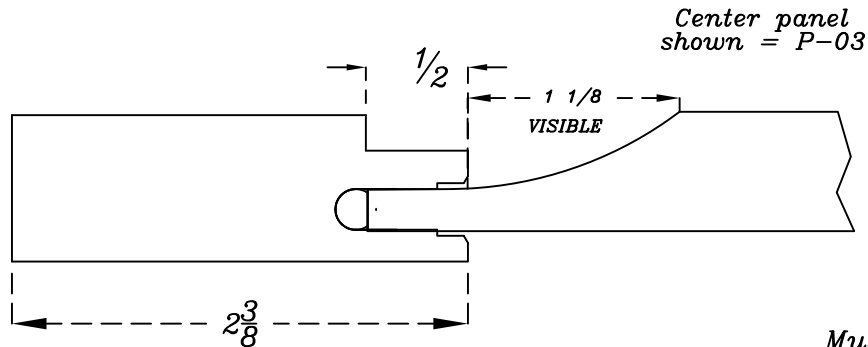

Mullion model

M011

5-PIECES DRAWER FRONT: # 4051/?

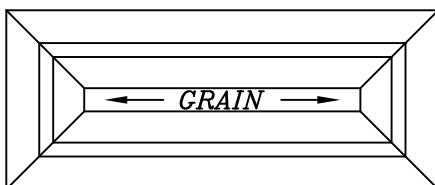

Minimum height and width available = 6 1/8"
 (With a visible of 1/8")

Rails and stiles = 1 11/16"

Mitered drawer front
 Match corresponding door's edge profile,
 framing bead and center panel profile

Doors

Prestige series

- 1 PROFILES
- 2 TRADITIONAL 90
- 3 DISTINCTIVE 90
- 4 CATHEDRAL 90
- 5 APPLIED MOULDINGS
- 6 PRESTIGE 45
- 7 WANSCOTS
- 8 SPECIALTY PRODUCTS
- 9 MOULDINGS
- 10 PROMOTIONAL ITEMS
- 11 POLICY

DOOR # 4600/?

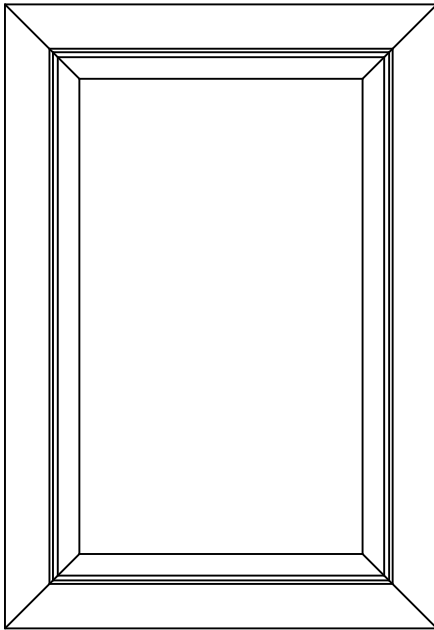

Minimum height and Width (solid) = 7 1/2"
Minimum height and width (veneer) = 6 1/2"

FRAME # 4605/?

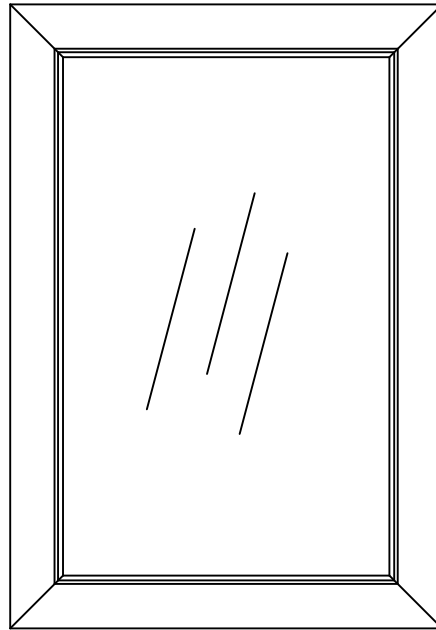

Minimum height and width = 6 1/2"

Center panel shown = P-03

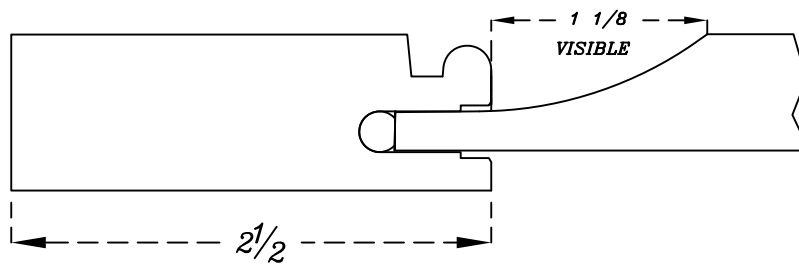

Mullion model

M053

5-PIECES DRAWER FRONT: # 4601/?

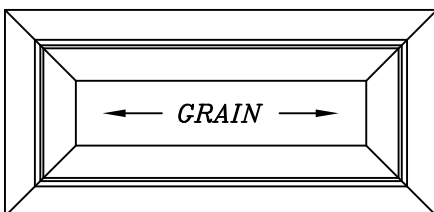

Minimum height and width available = 6 1/4"
(With a visible of 1/8")

Rails and stiles 1 3/4"

Mitered drawer front
Match corresponding door's edge profile, framing bead and center panel profile

Doors

Prestige series

DOOR # 4700/?

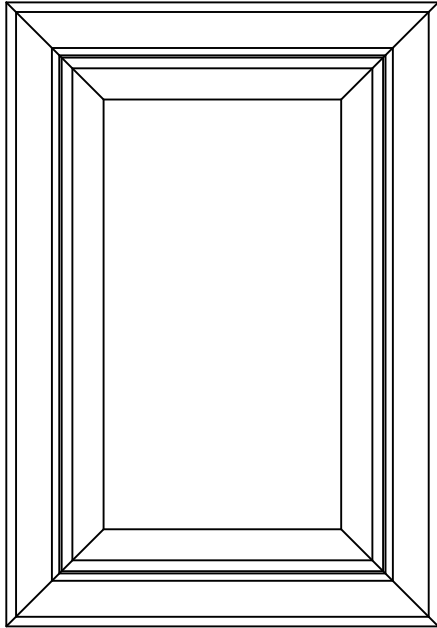

Minimum height and Width (solid) = 7"
Minimum height and width (veneer) = 6"

FRAME # 4705/?

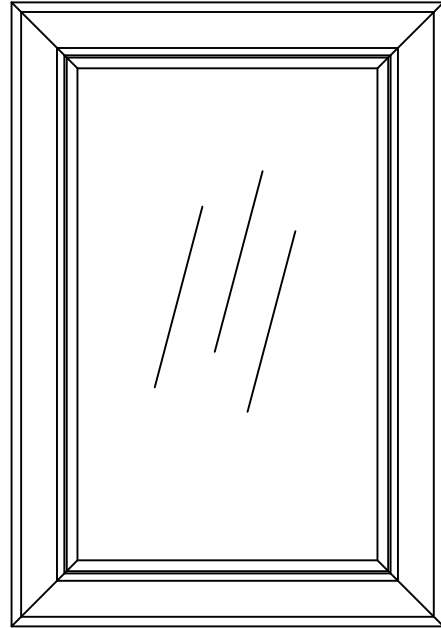

Minimum height and width = 6"

Center panel shown = P-03

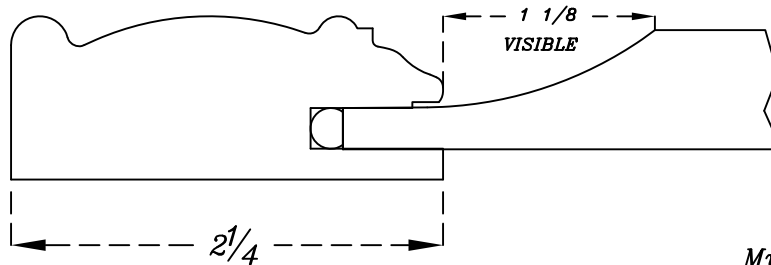

Mullion model

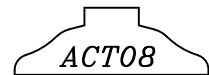

5-PIECES DRAWER FRONT: # 4701/?

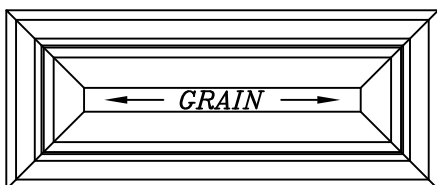

Minimum height and width available = 6 1/4"
(With a visible of 1/8")

Rails and stiles 1 3/4"

Mitered drawer front
Match corresponding door's edge profile,
framing bead and center panel profile

Doors

Prestige series

- 1 PROFILES
- 2 TRADITIONAL 90
- 3 DISTINCTIVE 90
- 4 CATHEDRAL 90
- 5 APPLIED MOULDINGS
- 6 PRESTIGE 45
- 7 WANSCOTS
- 8 SPECIALTY PRODUCTS
- 9 MOULDINGS
- 10 PROMOTIONAL ITEMS
- 11 POLICY

DOOR # 4800/?

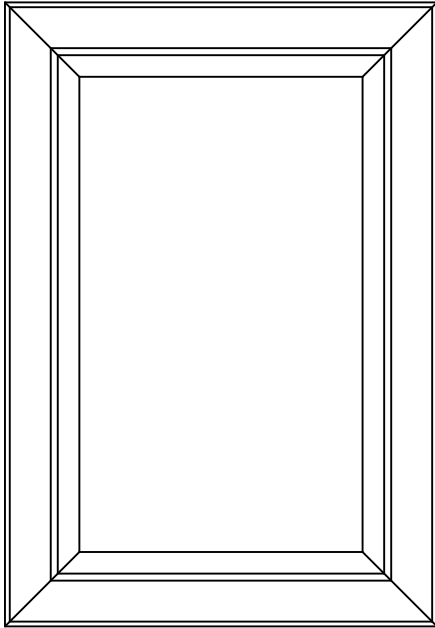

*Minimum height and Width (solid) = 8"
Minimum height and width (veneer) = 7"*

FRAME # 4805/?

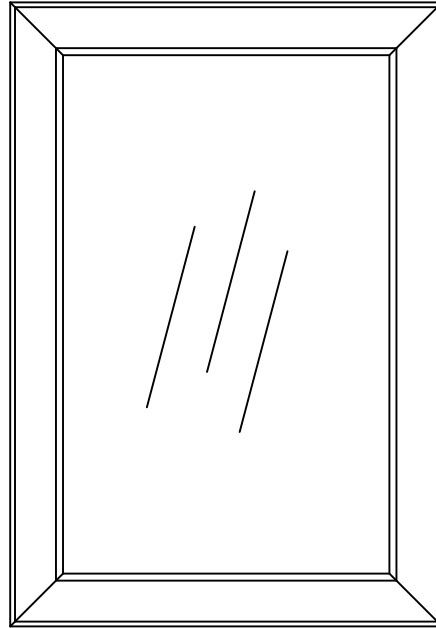

Minimum height and width = 7"

Center panel shown = P-03

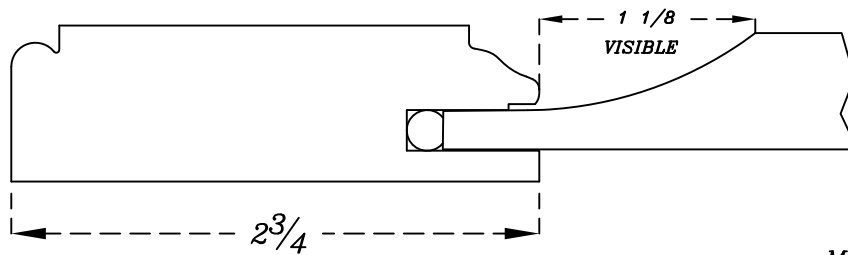

Mullion model

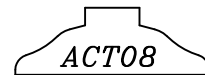

5-PIECES DRAWER FRONT: # 4801/?

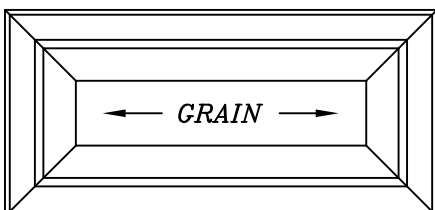

*Minimum height and width available = 6 1/4"
(With a visible of 1/8")*

Rails and stiles 1 3/4"

*Mitered drawer front
Match corresponding door's edge profile,
framing bead and center panel profile*

Doors

Prestige series

DOOR # 4900/?

FRAME # 4905/?

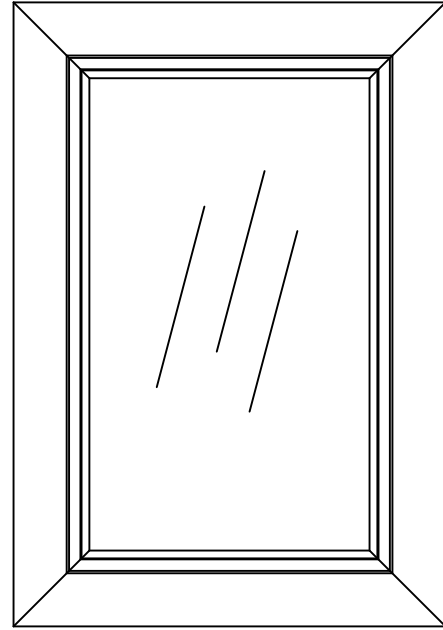
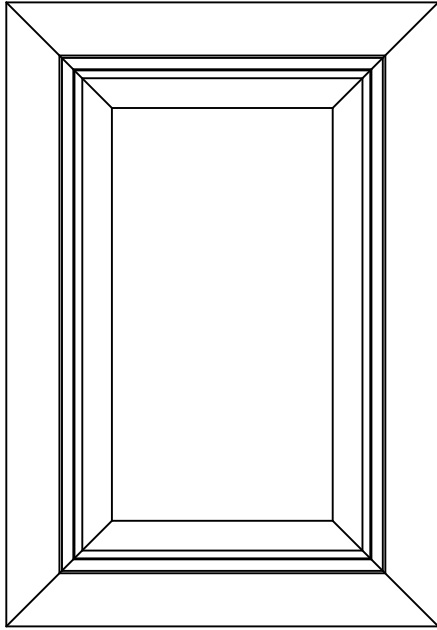

Minimum height and Width (solid) = 8 1/4"
Minimum height and width (veneer) = 7 1/4"

Minimum height and width = 7 1/4"

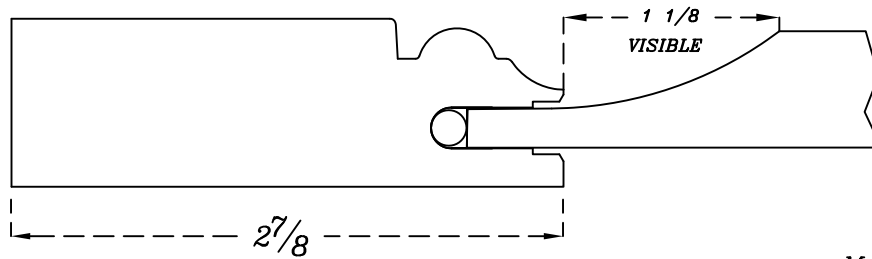

Mullion model

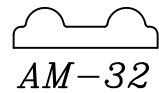

AM-32

5-PIECES DRAWER FRONT: # 4901/?

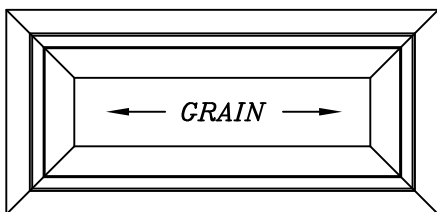

Minimum height and width available = 6 1/4"
(With a visible of 1/8")

Rails and stiles 1 3/4"

Mitered drawer front
Match corresponding door's edge profile,
framing bead and center panel profile

DOOR # 5000/???

FRAME # 5005/???

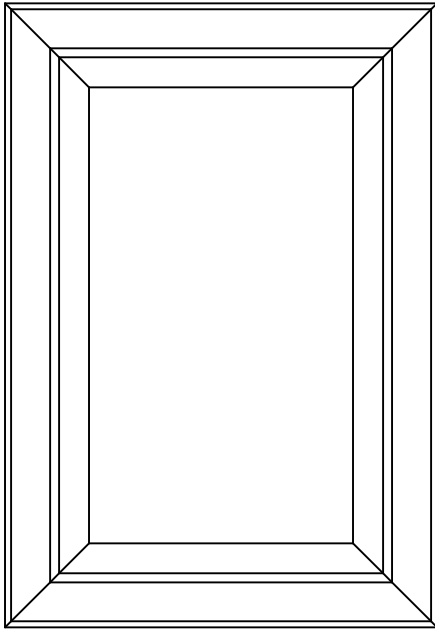

Minimum height and Width (solid) = 7 1/4"
Minimum height and width (veneer) = 6 1/4"

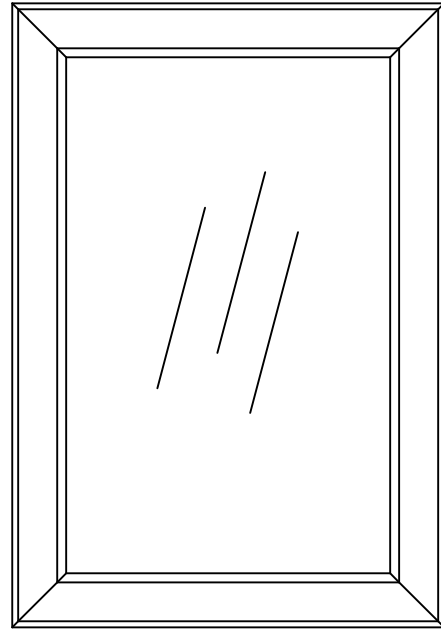

Width and Height minimum = 6 1/4"

Profil extérieur
shown = E-04

moulure intérieure
shown = A

Center panel
shown = P-03

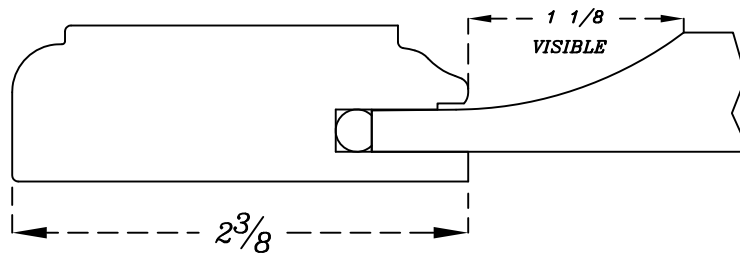

All framing beads of standard doors available

5-PIECE DRAWER FRONT: # 5001/???

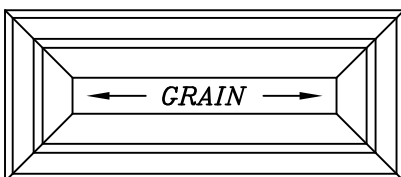

Minimum height and width available = 6 1/8"
(With a visible of 1/8")

Rails and stiles 1 11/16"

Mitered drawer front matches framing bead and center panel profile

Doors

Prestige series

DOOR # 5100/?

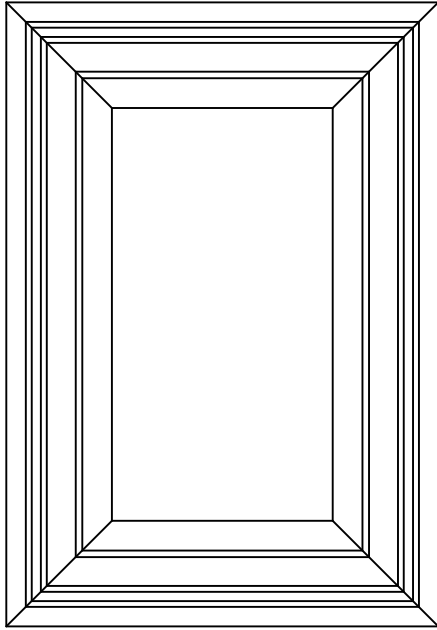

Minimum height and Width (solid) = 8 1/4"
Minimum height and width (veneer) = 7 1/4"

FRAME # 5105/?

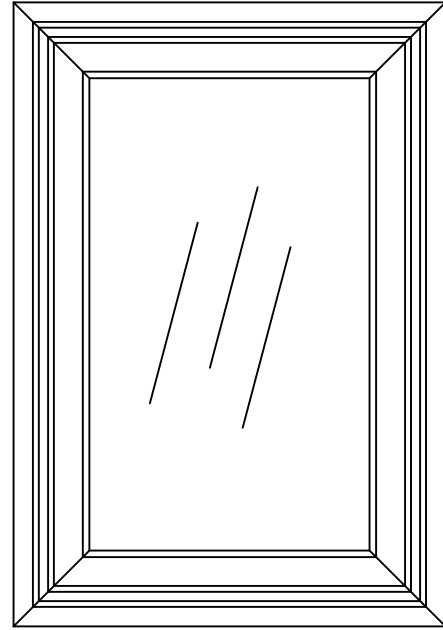

Minimum height and width = 7 1/4"

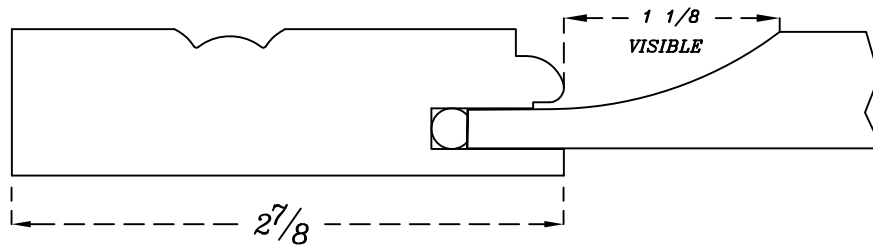

Mullion model

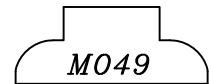

5-PIECES DRAWER FRONT: # 5101/?

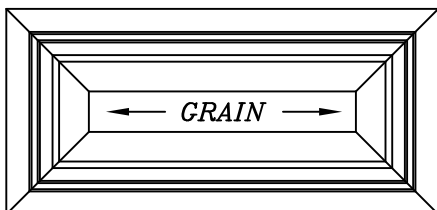

Minimum height and width available = 6 3/4"
(With a visible of 1/8")

Rails and stiles 2"

Mitered drawer front
Match corresponding door's edge profile,
framing bead and center panel profile

Doors

Prestige series

- 1 PROFILES
- 2 TRADITIONAL 90
- 3 DISTINCTIVE 90
- 4 CATHEDRAL 90
- 5 APPLIED MOULDINGS
- 6 PRESTIGE 45
- 7 WANSCOTS
- 8 SPECIALTY PRODUCTS
- 9 MOULDINGS
- 10 PROMOTIONAL ITEMS
- 11 POLICY

DOOR # 5200/?

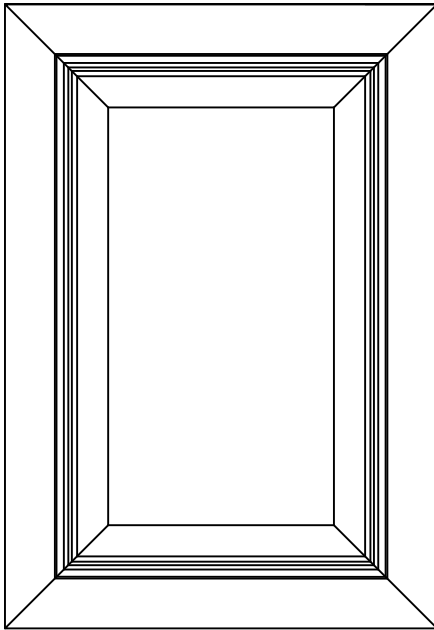

Minimum height and Width (solid) = 7 11/16"
Minimum height and width (veneer) = 6 11/16"

FRAME # 5205/?

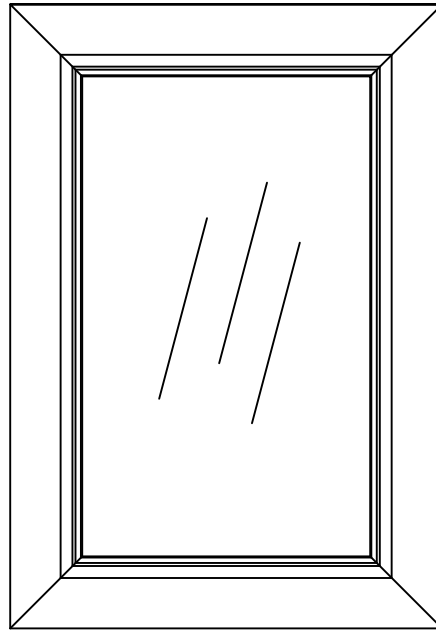

Minimum height and width = 6 11/16"

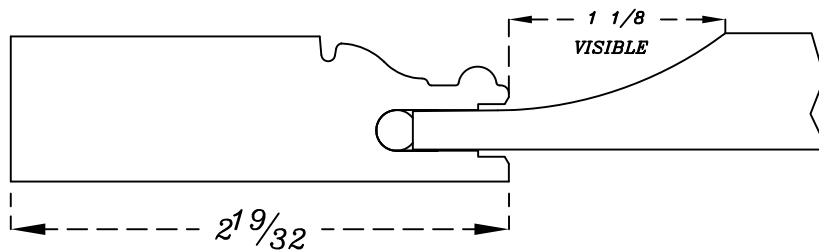

Mullion model



5-PIECES DRAWER FRONT: # 5201/?

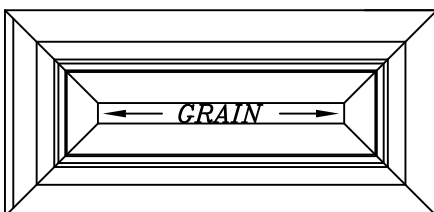

Minimum height and width available = 5 15/16"
(With a visible of 1/8")

Rails and stiles 1 19/32"

Mitered drawer front
Match corresponding door's edge profile,
framing bead and center panel profile

Doors

Prestige series

DOOR # 5300/?/?

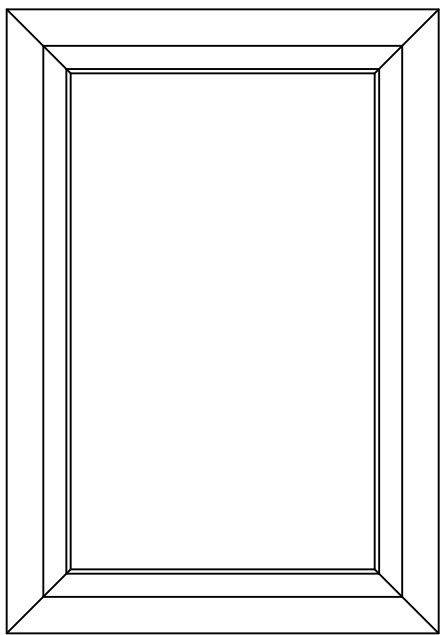

Minimum height and width = 5 1/4"

FRAME # 5305/?

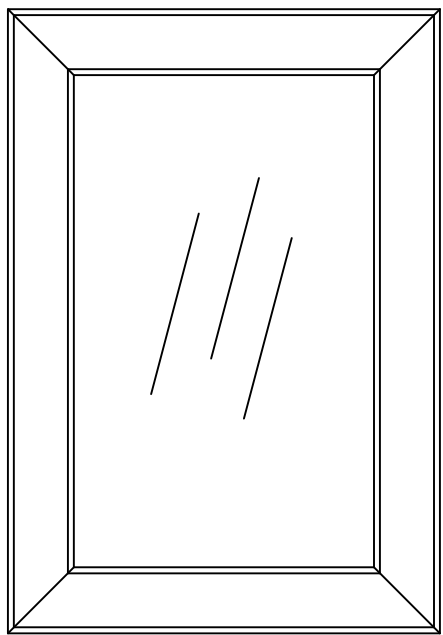

Minimum height and width = 5 1/4"

Edge profile shown = E-54

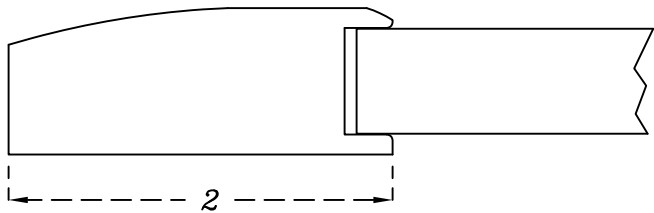

Mullion frame non-available

OPTIONS

?	center panel	VENEER	V-13
		MDF	M-V13

5-PIECE DRAWER FRONT: # 5301/??

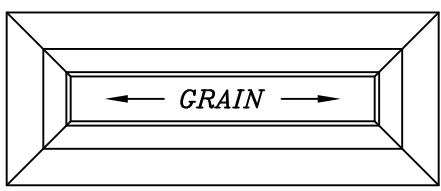

Minimum height and width available = 5 1/4"
(With a visible of 1/8")

Rails and stiles 2"

Mitered drawer front matches framing bead and center panel profile

Doors

Prestige series

- 1 PROFILES
- 2 TRADITIONAL 90
- 3 DISTINCTIVE 90
- 4 CATHEDRAL 90
- 5 APPLIED MOULDINGS
- 6 PRESTIGE 45
- 7 WANSCOTS
- 8 SPECIALTY PRODUCTS
- 9 MOULDINGS
- 10 PROMOTIONAL ITEMS
- 11 POLICY

DOOR # 5400/?

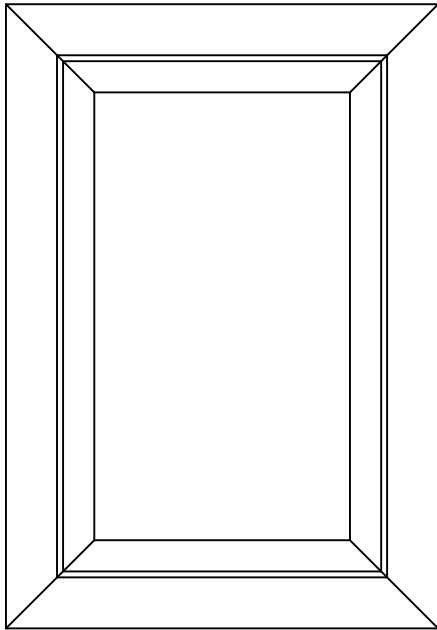

Minimum height and Width (solid) = 7 1/8"
Minimum height and width (veneer) = 6 1/4"

FRAME # 5405/?

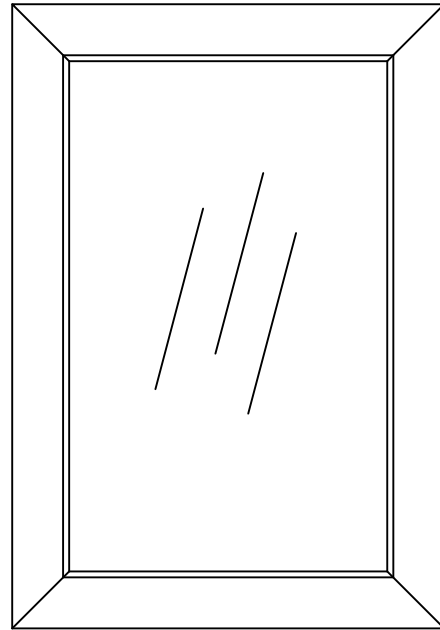

Minimum height and width = 6 1/4"

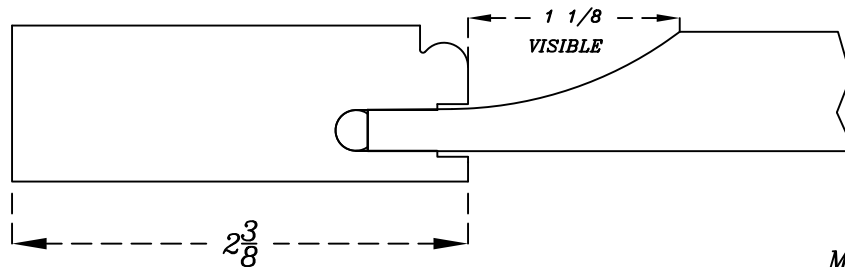

Mullion model

M053

5-PIECES DRAWER FRONT: # 5401/?

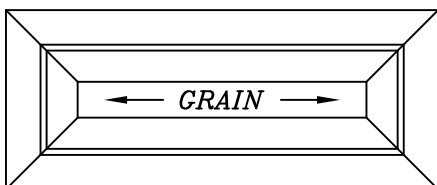

Minimum height and width available = 6 1/8"
(With a visible of 1/8")

Rails and stiles = 1 3/4"

Mitered drawer front
Match corresponding door's edge profile,
framing bead and center panel profile

Doors

Prestige series

DOOR # 5500/?

FRAME # 5505/?

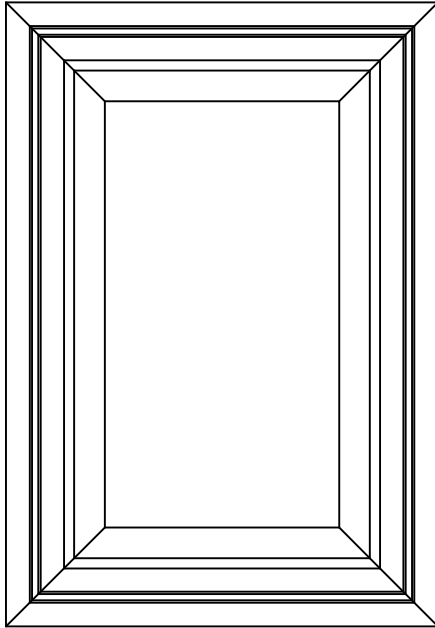

Minimum height and Width (solid) = 7 1/2"
Minimum height and width (veneer) = 6 1/2"

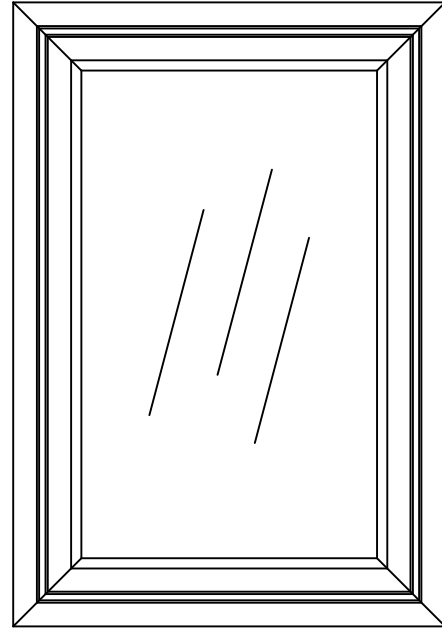

Minimum height and width = 6 1/2"

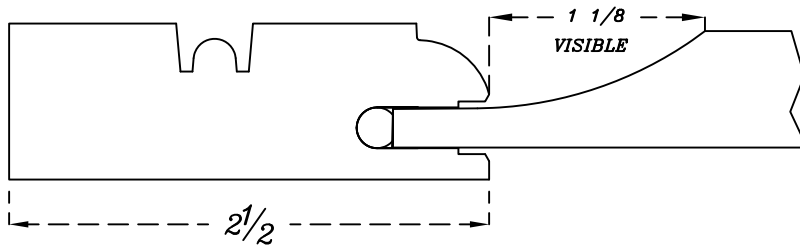

Mullion model

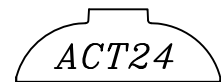

5-PIECES DRAWER FRONT: # 5501/?

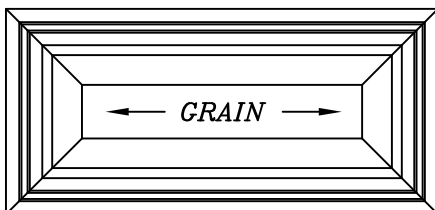

Minimum height and width available = 6 1/4"
(With a visible of 1/8")

Rails and stiles 1 3/4"

Mitered drawer front
Match corresponding door's edge profile,
framing bead and center panel profile

Doors

Prestige series

- 1 PROFILES
- 2 TRADITIONAL 90
- 3 DISTINCTIVE 90
- 4 CATHEDRAL 90
- 5 APPLIED MOULDINGS
- 6 PRESTIGE 45
- 7 WANSCOTS
- 8 SPECIALTY PRODUCTS
- 9 MOULDINGS
- 10 PROMOTIONAL ITEMS
- 11 POLICY

DOOR # 5600/?

FRAME # 5605/?

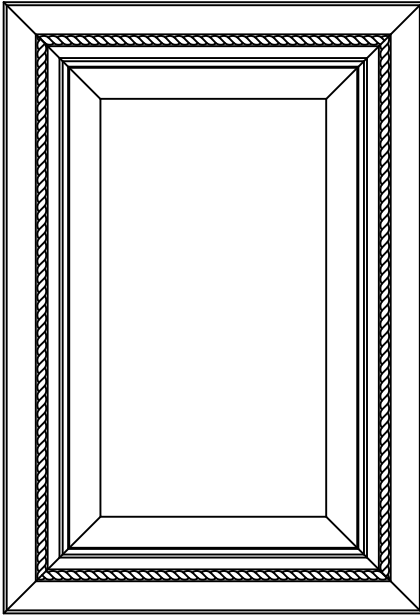

*Minimum height and Width (solid) = 8"
Minimum height and width (veneer) = 7"*

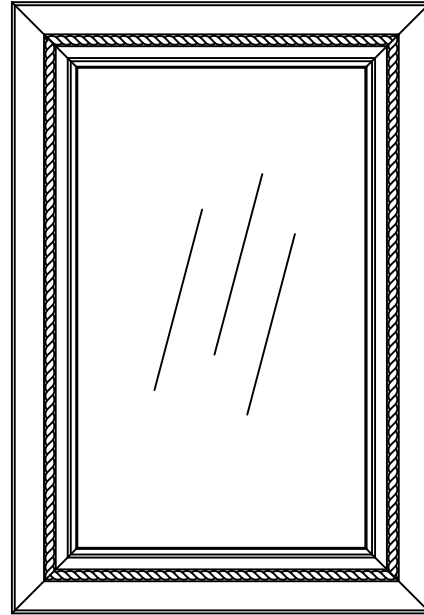

Minimum height and width = 7"

*Rope 3/8" (AM25)
only,
always included*

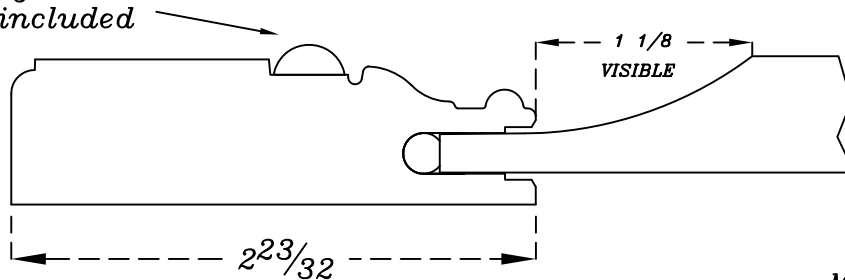

Mullion model

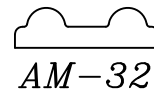

5-PIECES DRAWER FRONT: # 5601/?

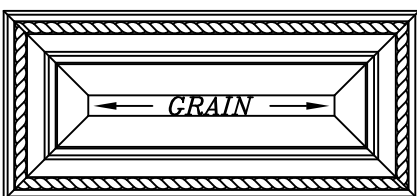

*Minimum height and width available = 6 1/4"
(With a visible of 1/8")*

Rails and stiles 1 23/32"

*Mitered drawer front
Match corresponding door's edge profile,
framing bead and center panel profile*

Doors

Prestige series

DOOR # 5700/?

FRAME # 5705/?

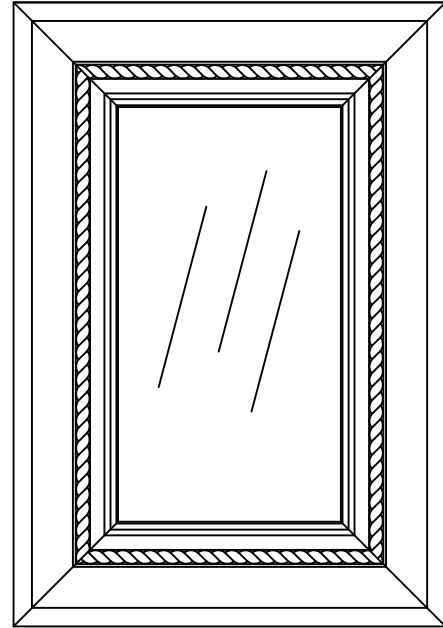
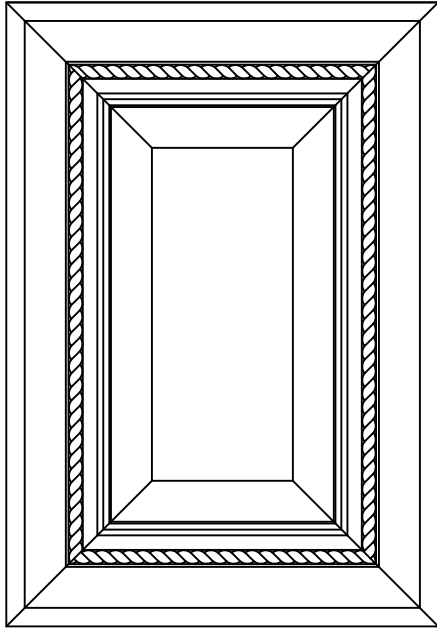

Minimum height and Width (solid) = 8 1/4"
Minimum height and width (veneer) = 7 1/4"

Minimum height and width = 7 1/4"

Rope 3/8" (AM25)
only,
always included

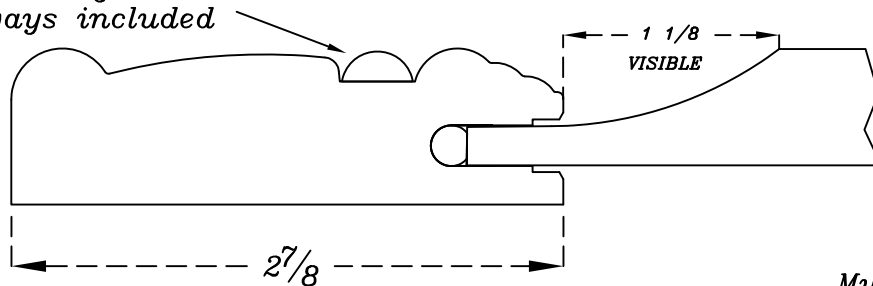

Mullion model

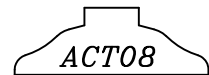

5-PIECES DRAWER FRONT: # 5701/?

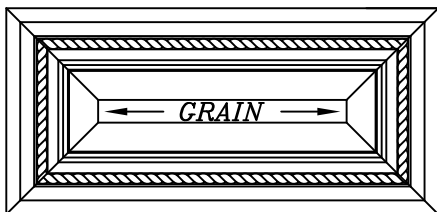

Rails and stiles 2 1/4"

Minimum height and width available = 7 1/4"
(With a visible of 1/8")

Mitered drawer front
Match corresponding door's edge profile,
framing bead and center panel profile

Doors

Prestige series

- 1 PROFILES
- 2 TRADITIONAL 90
- 3 DISTINCTIVE 90
- 4 CATHEDRAL 90
- 5 APPLIED MOULDINGS
- 6 PRESTIGE 45
- 7 WANSCOTS
- 8 SPECIALTY PRODUCTS
- 9 MOULDINGS
- 10 PROMOTIONAL ITEMS
- 11 POLICY

DOOR # 5800/?

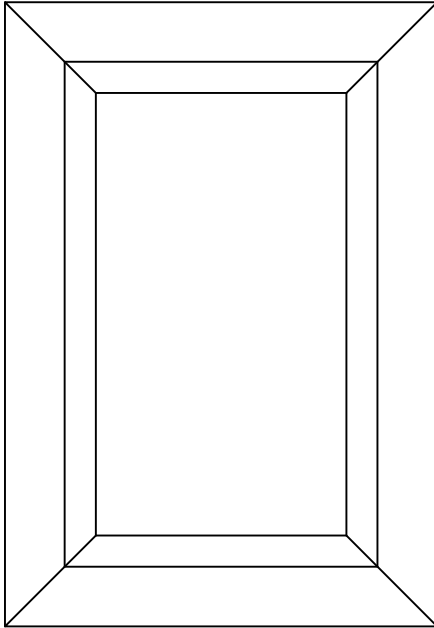

Minimum height and Width (solid) = 7 1/2"
Minimum height and width (veneer) = 6 1/2"

FRAME # 5805/?

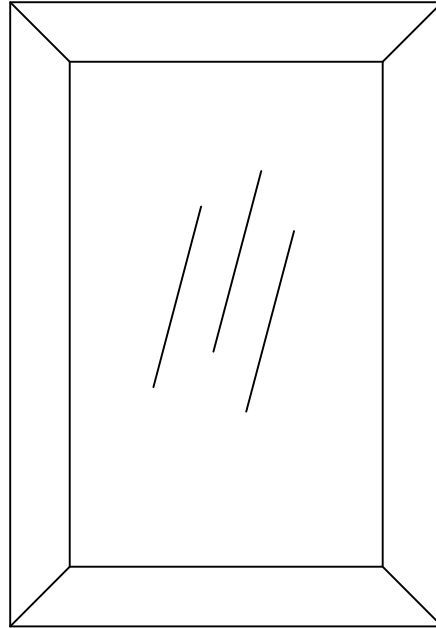

Minimum height and width = 6 1/2"

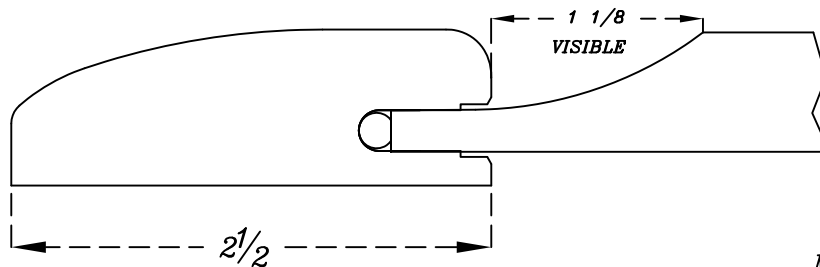

Mullion model

M053

5-PIECES DRAWER FRONT: # 5801/?

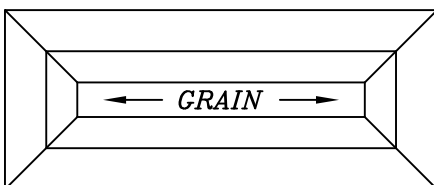

Minimum height and width available = 6 3/4"
(With a visible of 1/8")

Rails and stiles = 2"

Mitered drawer front
Match corresponding door's edge profile,
framing bead and center panel profile

Doors

Prestige series

DOOR # 5900/?

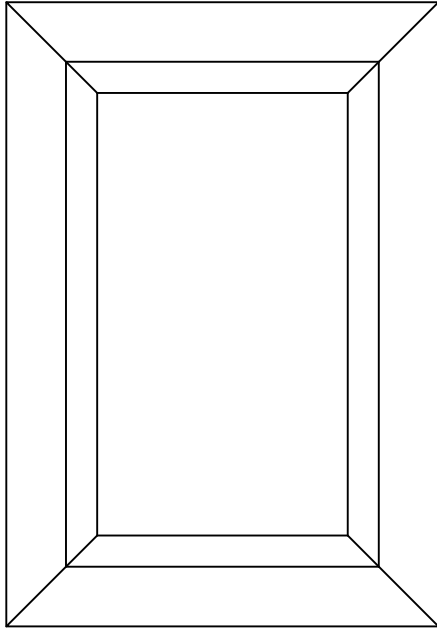

Minimum height and Width (solid) = 7 1/2"
Minimum height and width (veneer) = 6 1/2"

FRAME # 5905/?

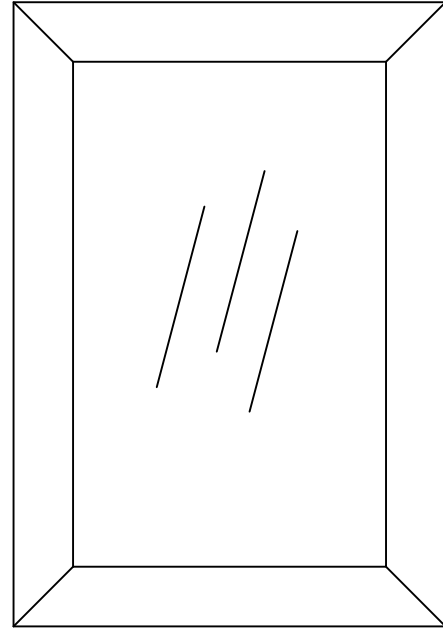

Minimum height and width = 6 1/2"

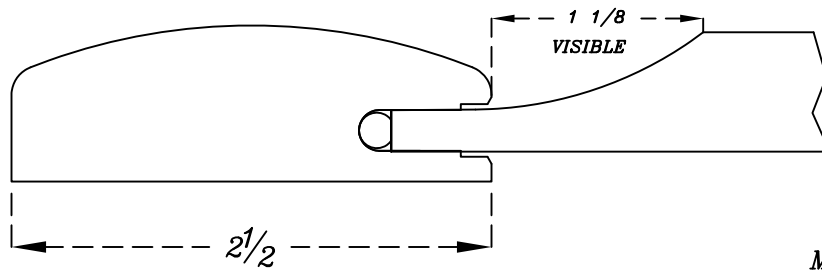

Mullion model

M053

5-PIECES DRAWER FRONT: # 5901/?

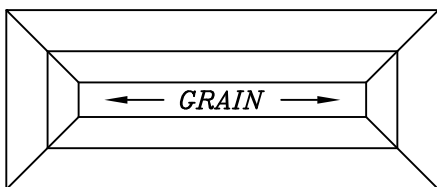

Minimum height and width available = 6 3/4"
(With a visible of 1/8")

Rails and stiles = 2"

Mitered drawer front
Match corresponding door's edge profile,
framing bead and center panel profile

Doors

Prestige series

- 1 PROFILES
- 2 TRADITIONAL 90
- 3 DISTINCTIVE 90
- 4 CATHEDRAL 90
- 5 APPLIED MOULDINGS
- 6 PRESTIGE 45
- 7 WAINSCOTS
- 8 SPECIALTY PRODUCTS
- 9 MOULDINGS
- 10 PROMOTIONAL ITEMS
- 11 POLICY

DOOR # 6000/???

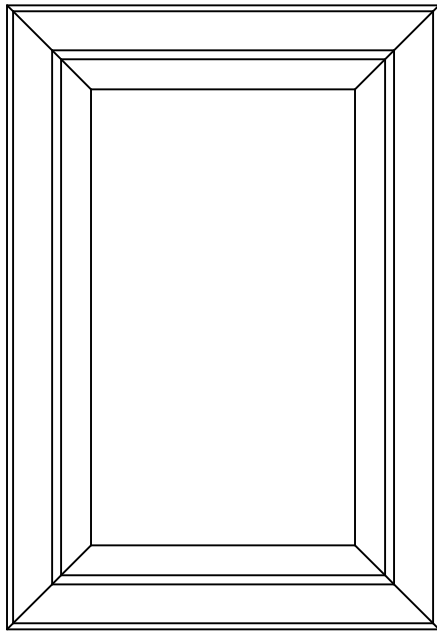

Minimum height and Width (solid) = 8 1/2"
Minimum height and width (veneer) = 7 1/2"

FRAME # 6005/???

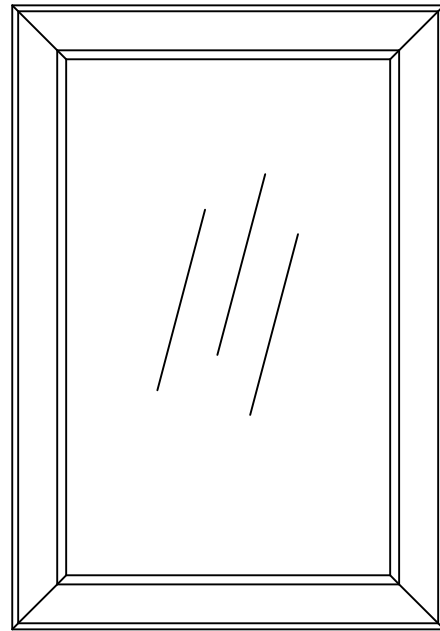

Width and Height minimum = 7 1/2"

Edge profile shown = E-04

Framing bead shown = A

Center panel shown = P-03

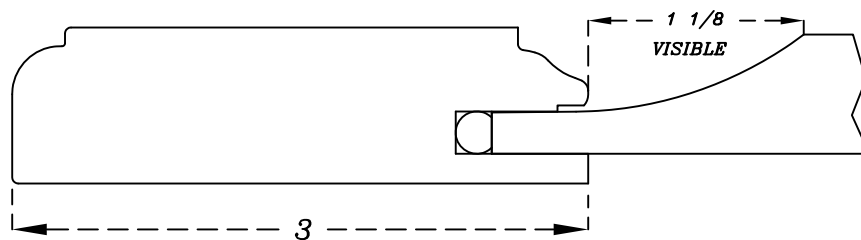

All framing beads of standard doors available

5-PIECE DRAWER FRONT: # 6001/???

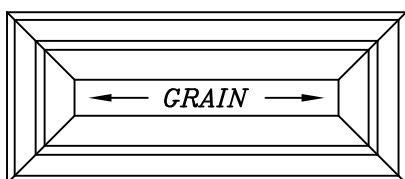

Minimum height and width available = 6 1/8"
(With a visible of 1/8")

Rails and stiles 1 11/16"

Mitered drawer front matches framing bead and center panel profile

Doors

Prestige series

DOOR # 6100/?

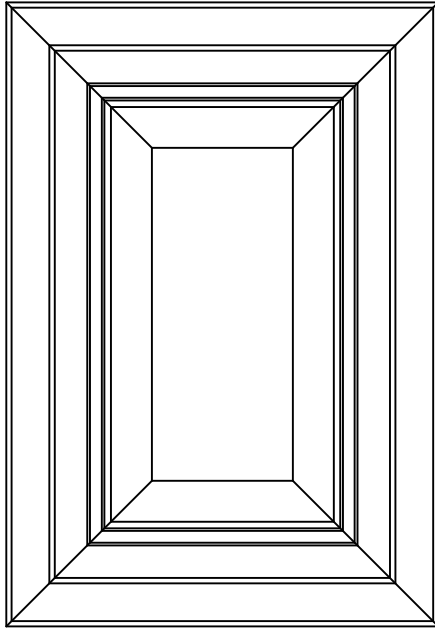

Minimum height and Width (solid) = 8 1/4"
Minimum height and width (veneer) = 7 1/4"

FRAME # 6105/?

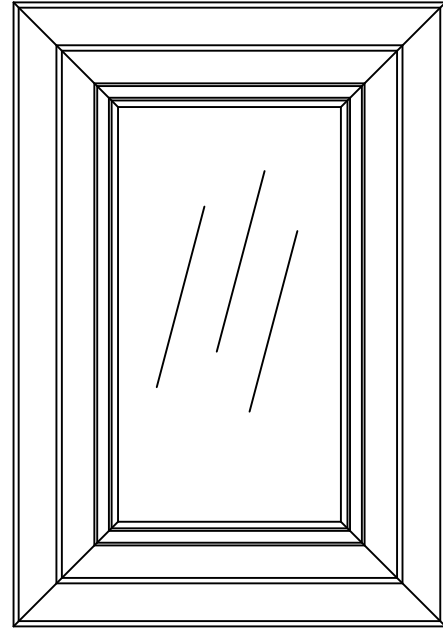

Minimum height and width = 7 1/4"

Center panel shown = P-03

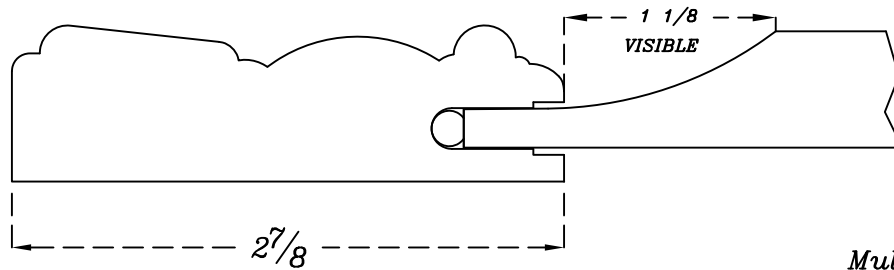

Mullion model

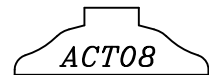

5-PIECES DRAWER FRONT: # 6101/?

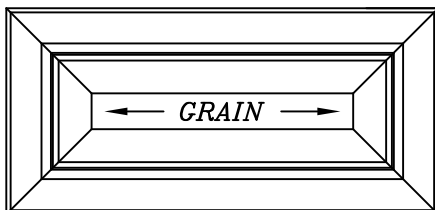

Minimum height and width available = 6 1/2"
(With a visible of 1/8")

Rails and stiles = 1 7/8"

Mitered drawer front
Match corresponding door's edge profile,
framing bead and center panel profile

Doors

Prestige series

- 1 PROFILES
- 2 TRADITIONAL 90
- 3 DISTINCTIVE 90
- 4 CATHEDRAL 90
- 5 APPLIED MOULDINGS
- 6 PRESTIGE 45
- 7 WANSCOTS
- 8 SPECIALTY PRODUCTS
- 9 MOULDINGS
- 10 PROMOTIONAL ITEMS
- 11 POLICY

DOOR # 6200/?

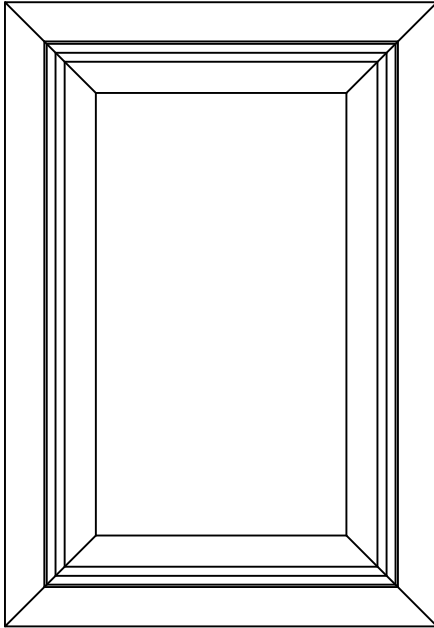

Minimum height and Width (solid) = 7 1/2"
Minimum height and width (veneer) = 6 1/2"

FRAME # 6205/?

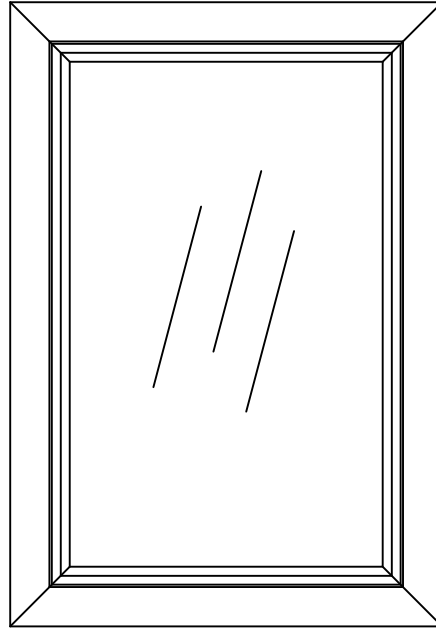

Minimum height and width = 6 1/2"

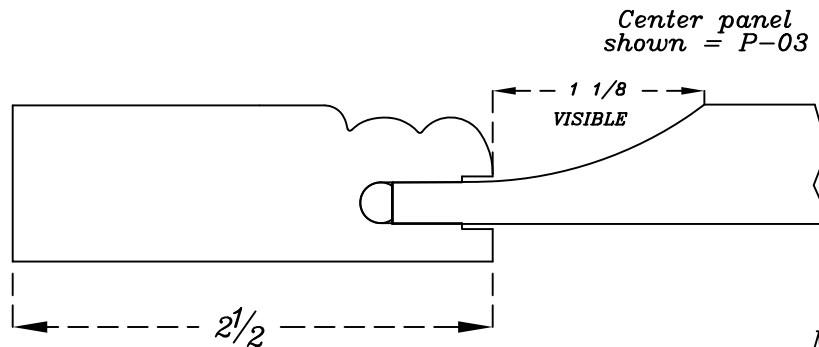

Mullion model

M053

5-PIECES DRAWER FRONT: # 6201/?

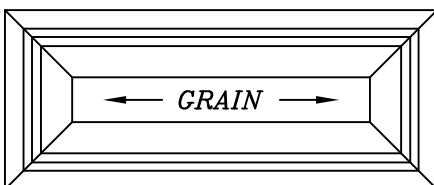

Minimum height and width available = 6 1/4"
(With a visible of 1/8")

Rails and stiles = 1 3/4"

Mitered drawer front
Match corresponding door's edge profile,
framing bead and center panel profile

Doors

Prestige series

DOOR # 6400/?

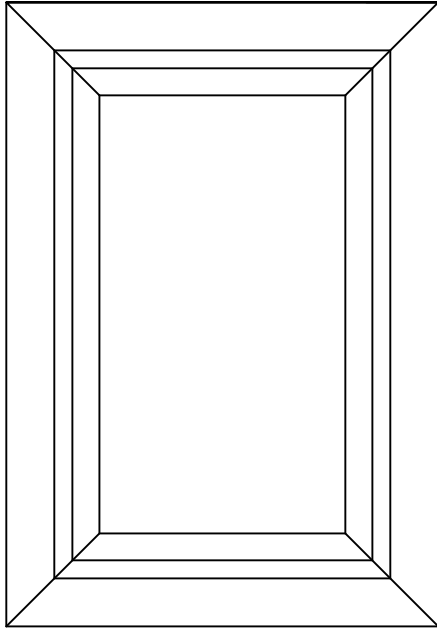

Minimum height and Width (solid) = 8"
Minimum height and width (veneer) = 7"

FRAME # 6405/?

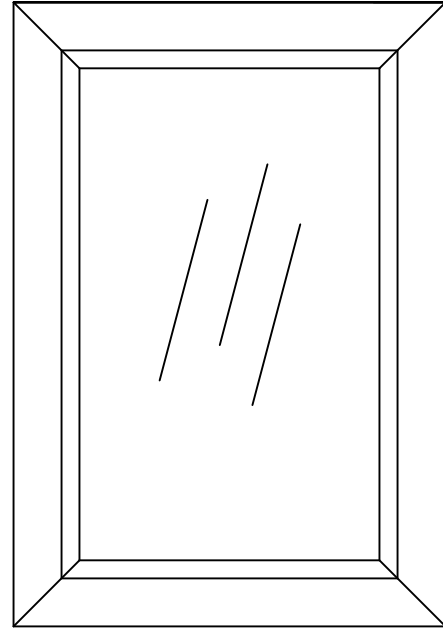

Minimum height and width = 7"

Center panel shown = P-03

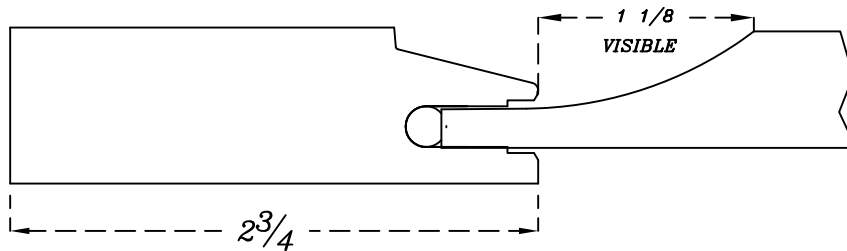

Mullion model



5-PIECES DRAWER FRONT: # 6401/?

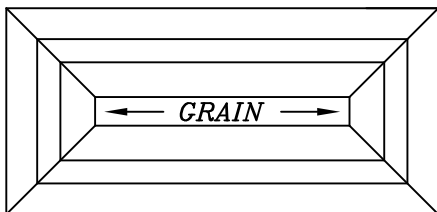

Minimum height and width available = 6 1/4"
(With a visible of 1/8")

Rails and stiles 1 3/4"

Mitered drawer front
Match corresponding door's edge profile,
framing bead and center panel profile

Doors

Prestige series

- 1 PROFILES
- 2 TRADITIONAL 90
- 3 DISTINCTIVE 90
- 4 CATHEDRAL 90
- 5 APPLIED MOULDINGS
- 6 PRESTIGE 45
- 7 WANSCOTS
- 8 SPECIALTY PRODUCTS
- 9 MOULDINGS
- 10 PROMOTIONAL ITEMS
- 11 POLICY

DOOR # 6500/?

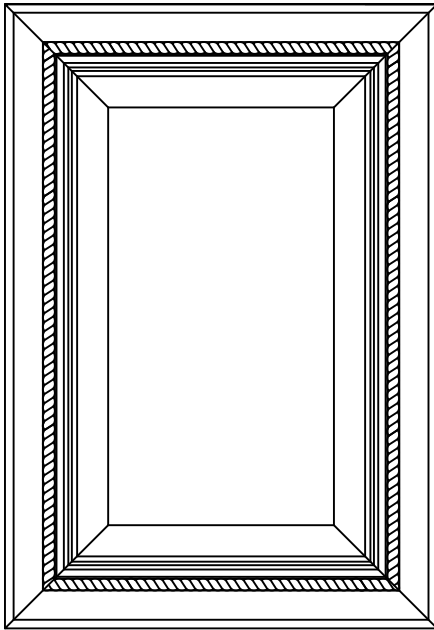

Minimum height and Width (solid) = 8 1/2"
Minimum height and width (veneer) = 7 1/2"

FRAME # 6505/?

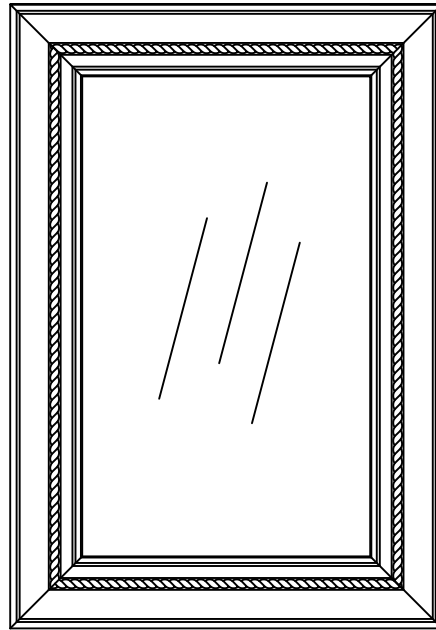

Minimum height and width = 7 1/2"

*Rope 3/8" (AM25)
 only,
 always included*

*Center panel
 shown = P-03*

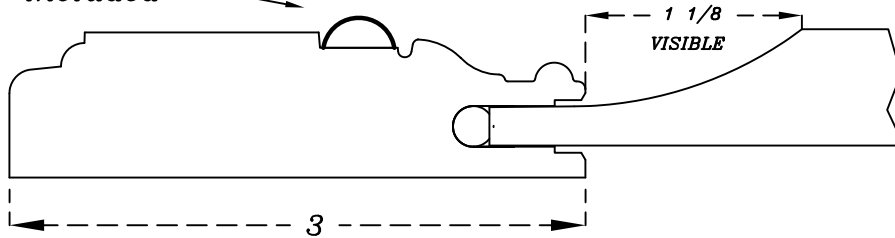

Mullion model

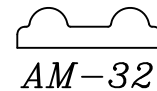

AM-32

5-PIECES DRAWER FRONT: # 6501/?

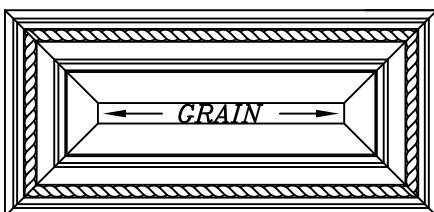

Minimum height and width available = 6 3/4"
(With a visible of 1/8")

Rails and stiles 2"

*Mitered drawer front
 Match corresponding door's edge profile,
 framing bead and center panel profile*

Doors

Prestige series

DOOR # 6600/?

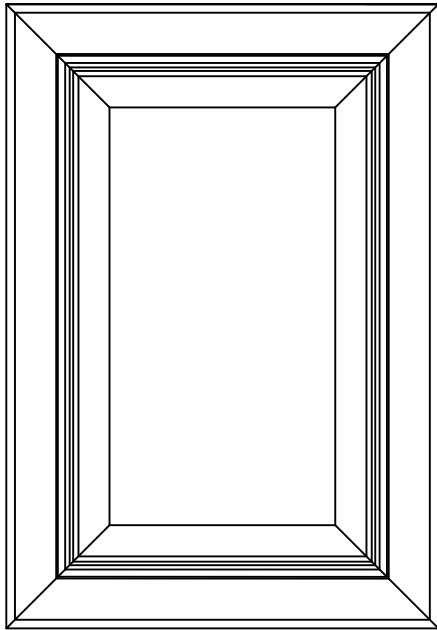

Minimum height and Width (solid) = 8 1/2"
Minimum height and width (veneer) = 7 1/2"

FRAME # 6605/?

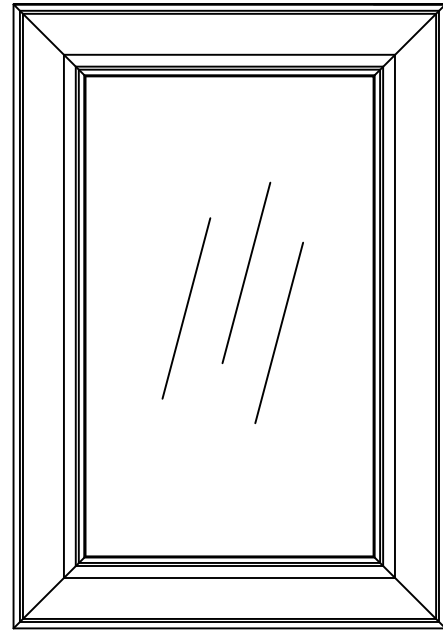

Minimum height and width = 7 1/2"

Center panel shown = P-03

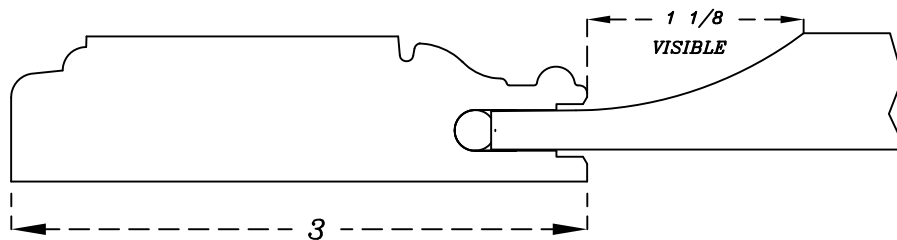

Mullion model

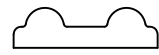

AM-32

5-PIECES DRAWER FRONT: # 6601/?

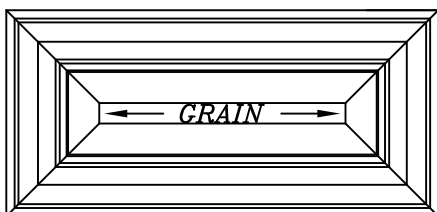

Minimum height and width available = 6 3/4"
(With a visible of 1/8")

Rails and stiles 2"

Mitered drawer front
Match corresponding door's edge profile,
framing bead and center panel profile

Doors

Prestige series

- 1 PROFILES
- 2 TRADITIONAL 90
- 3 DISTINCTIVE 90
- 4 CATHEDRAL 90
- 5 APPLIED MOULDINGS
- 6 PRESTIGE 45
- 7 WANNSCOTS
- 8 SPECIALTY PRODUCTS
- 9 MOULDINGS
- 10 PROMOTIONAL ITEMS
- 11 POLICY

DOOR # 6700/?

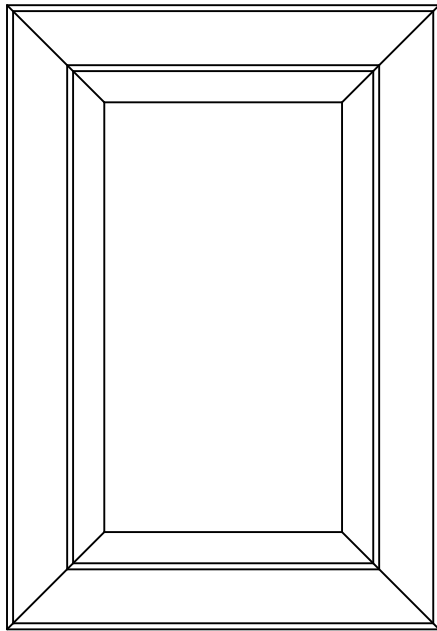

*Minimum height and Width (solid) = 7"
Minimum height and width (veneer) = 6"*

FRAME # 6705/?

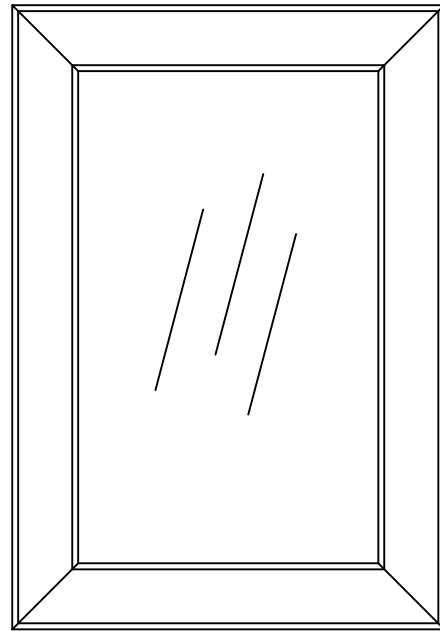

Minimum height and width = 6"

Center panel shown = P-03

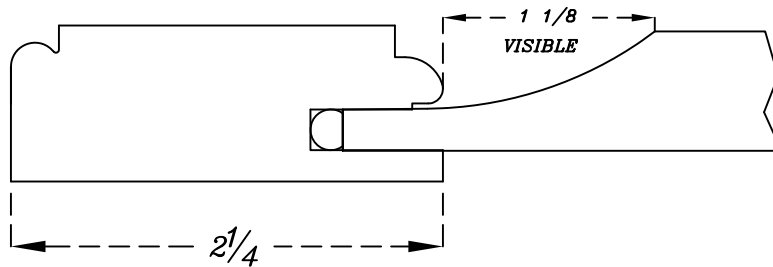

Mullion model

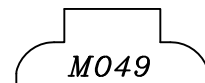

5-PIECE DRAWER FRONT: # 6701/?

*Standard rails and stiles 1 1/2"
Optional rails and stiles 2"*

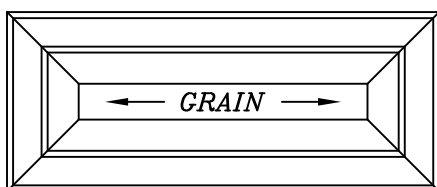

*Minimum height and width available = 6 1/4"
(With a visible of 1/8")*

*If the option 2 " is not specified,
front will be produced at 1 1/2 "*

*Mitered drawer front matches
framing bead and center panel profile*

Doors

Prestige series

DOOR # 6800/?

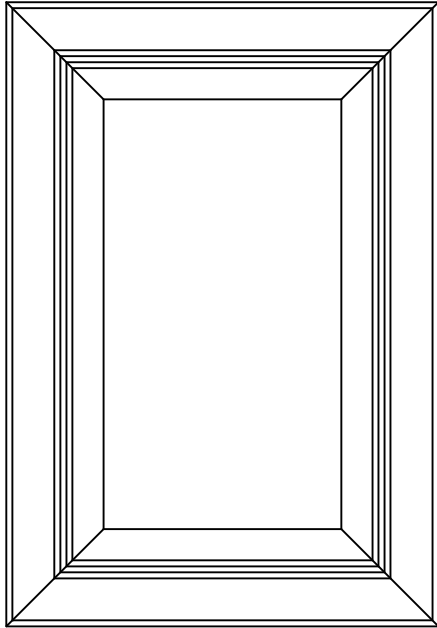

Minimum height and Width (solid) = 7"
Minimum height and width (veneer) = 6"

FRAME # 6805/?

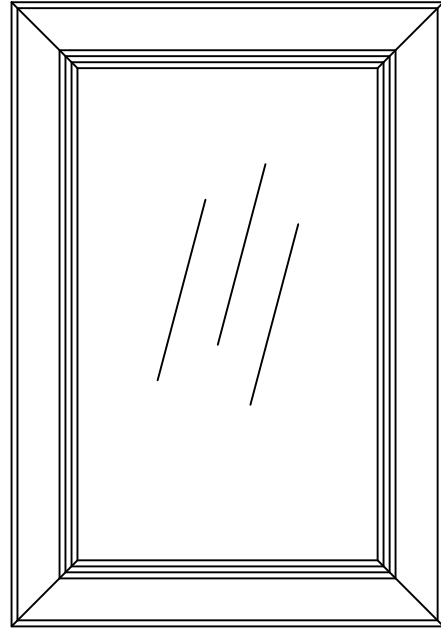

Minimum height and width = 6"

Center panel shown = P-03

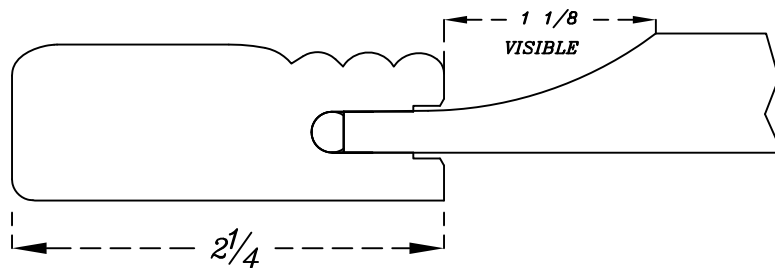

Mullion model

M053

5-PIECES DRAWER FRONT: # 6801/?

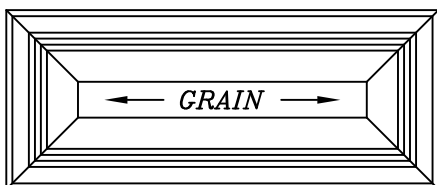

Minimum height and width available = 6 1/4"
(With a visible of 1/8")

Rails and stiles = 1 3/4"

Mitered drawer front
Match corresponding door's edge profile,
framing bead and center panel profile

Doors

Prestige series

- 1 PROFILES
- 2 TRADITIONAL 90
- 3 DISTINCTIVE 90
- 4 CATHEDRAL 90
- 5 APPLIED MOULDINGS
- 6 PRESTIGE 45
- 7 WANSCOTS
- 8 SPECIALTY PRODUCTS
- 9 MOULDINGS
- 10 PROMOTIONAL ITEMS
- 11 POLICY

DOOR # 6900/?

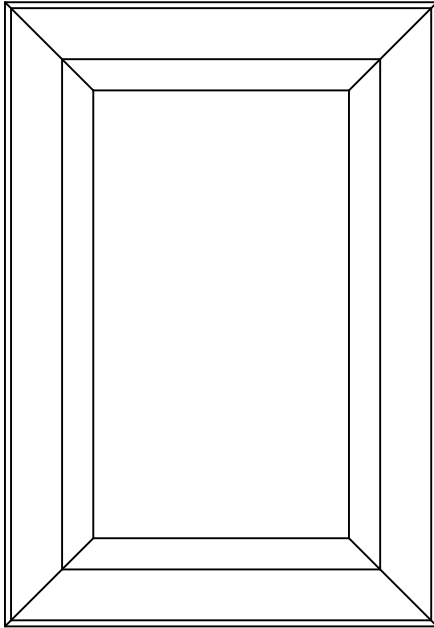

*Minimum height and Width (solid) = 8"
Minimum height and width (veneer) = 7"*

FRAME # 6905/?

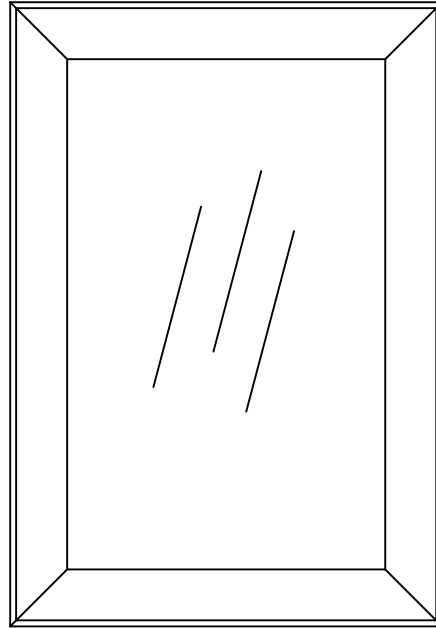

Minimum height and width = 7"

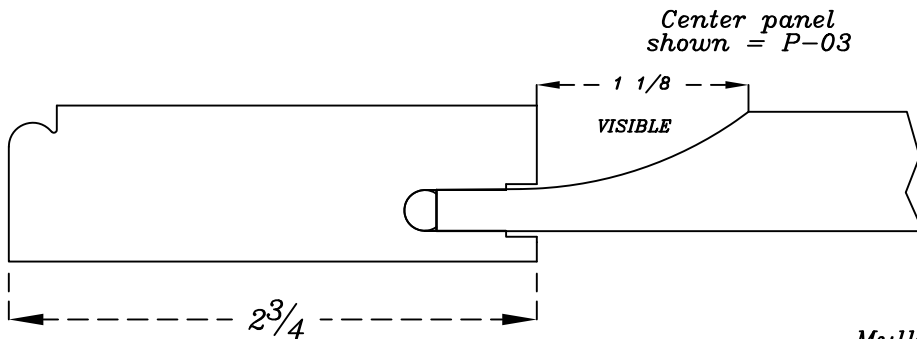

Mullion model

M011

5-PIECES DRAWER FRONT: # 6901/?

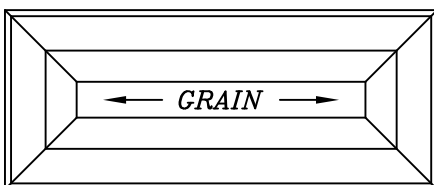

*Minimum height and width available = 5 3/4"
(With a visible of 1/8")*

Rails and stiles = 1 1/2"

*Mitered drawer front
Match corresponding door's edge profile,
framing bead and center panel profile*

Doors

Prestige series

DOOR # 7000/?

FRAME # 7005/?

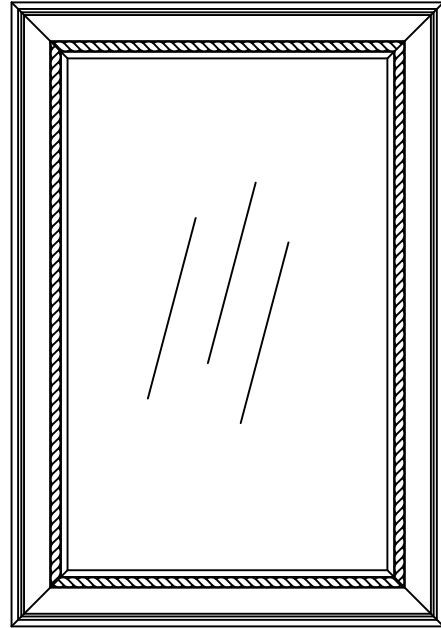
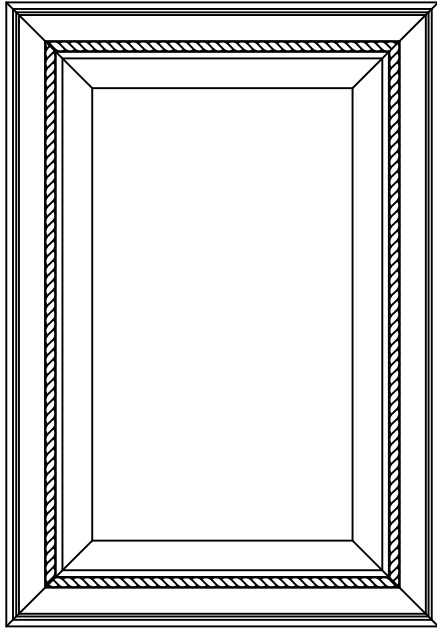

Minimum height and Width (solid) = 6 3/4"
Minimum height and width (veneer) = 5 3/4"

Minimum height and width = 5 3/4"

Rope 3/8" (AM25)
only,
always included

Center panel
shown = P-03

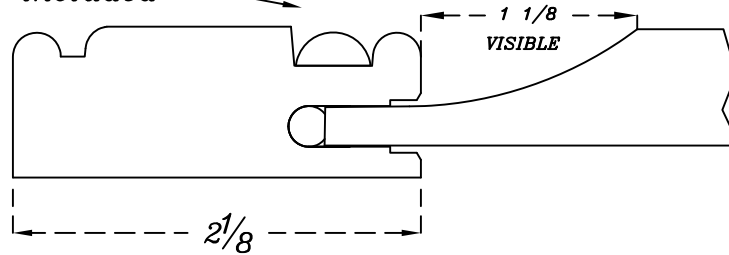

Mullion model

M053

5-PIECES DRAWER FRONT: # 7001/?

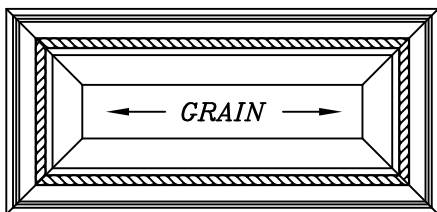

Rails and stiles 1 3/4"

Minimum height and width available = 6 1/4"
(With a visible of 1/8")

Mitered drawer front
Match corresponding door's edge profile,
framing bead and center panel profile

Doors

Prestige series

- 1 PROFILES
- 2 TRADITIONAL 90
- 3 DISTINCTIVE 90
- 4 CATHEDRAL 90
- 5 APPLIED MOULDINGS
- 6 PRESTIGE 45
- 7 WANSCOTS
- 8 SPECIALTY PRODUCTS
- 9 MOULDINGS
- 10 PROMOTIONAL ITEMS
- 11 POLICY

DOOR # 7100/?

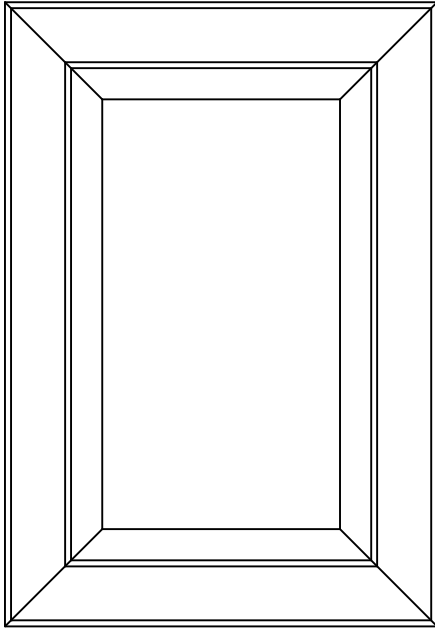

*Minimum height and Width (solid) = 7"
Minimum height and width (veneer) = 6"*

FRAME # 7105/?

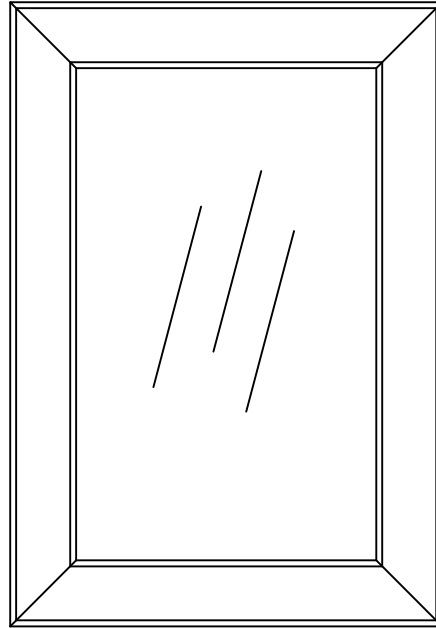

Minimum height and width = 6"

Center panel shown = P-03

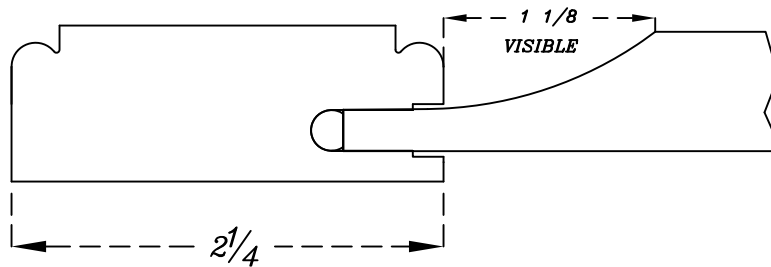

Mullion model

M053

5-PIECES DRAWER FRONT: # 7101/?

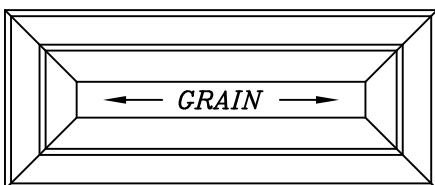

*Minimum height and width available = 6 1/4"
(With a visible of 1/8")*

Rails and stiles = 1 3/4"

*Mitered drawer front
Match corresponding door's edge profile,
framing bead and center panel profile*

Doors

Prestige series

DOOR # 7200/?

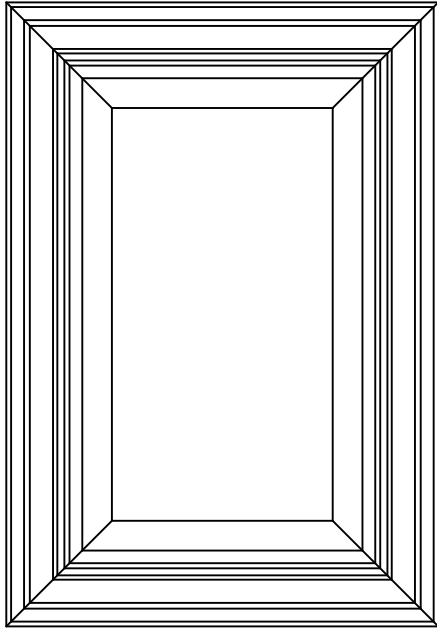

Minimum height and Width (solid) = 8 1/4"
Minimum height and width (veneer) = 7 1/4"

FRAME # 7205/?

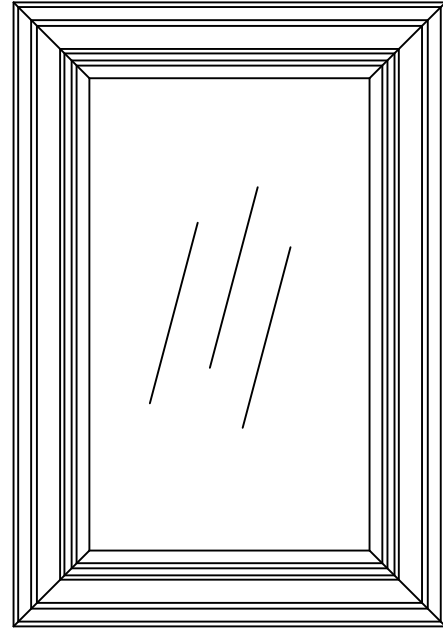

Minimum height and width = 7 1/4"

Center panel shown = P-03

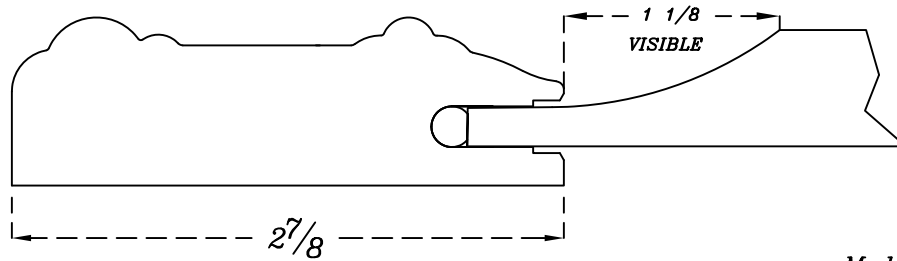

Mullion model

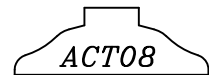

5-PIECES DRAWER FRONT: # 7201/?

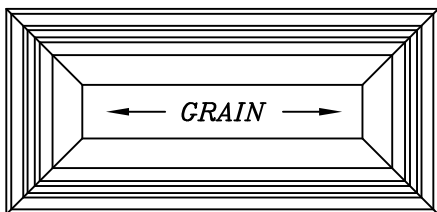

Minimum height and width available = 6 1/4"
(With a visible of 1/8")

Rails and stiles 1 3/4"

Mitered drawer front
Match corresponding door's edge profile,
framing bead and center panel profile

Doors

Prestige series

- 1 PROFILES
- 2 TRADITIONAL 90
- 3 DISTINCTIVE 90
- 4 CATHEDRAL 90
- 5 APPLIED MOULDINGS
- 6 PRESTIGE 45
- 7 WANSCOTS
- 8 SPECIALTY PRODUCTS
- 9 MOULDINGS
- 10 PROMOTIONAL ITEMS
- 11 POLICY

DOOR # 7300/?

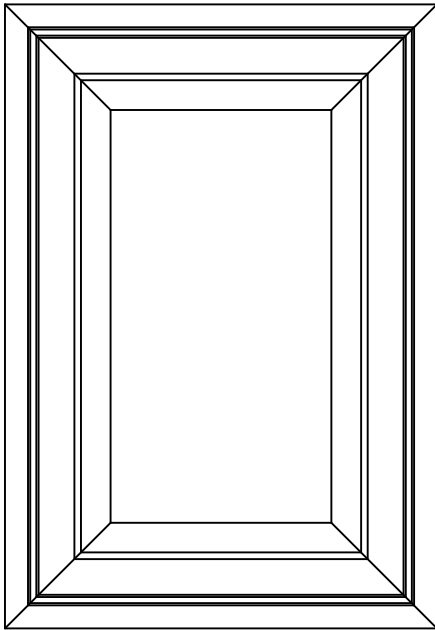

Minimum height and Width (solid) = 8 1/4"
Minimum height and width (veneer) = 7 1/4"

FRAME # 7305/?

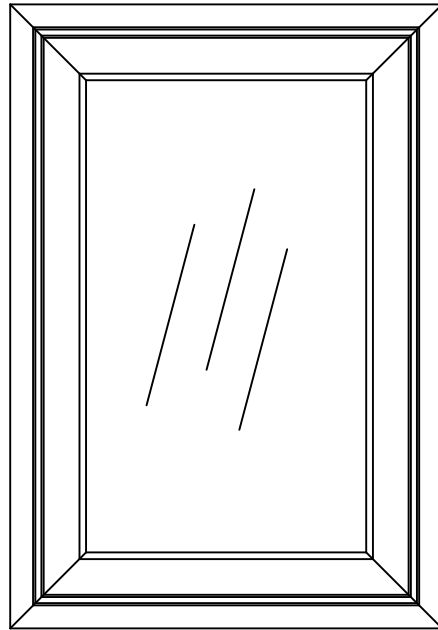

Minimum height and width = 7 1/4"

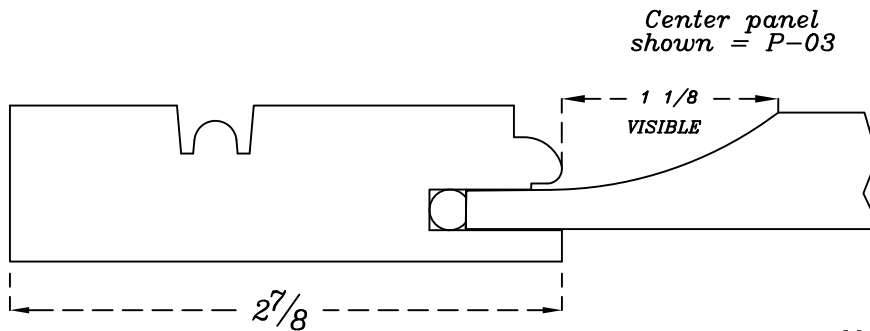

Mullion model

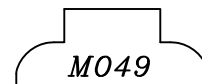

5-PIECES DRAWER FRONT: # 7301/?

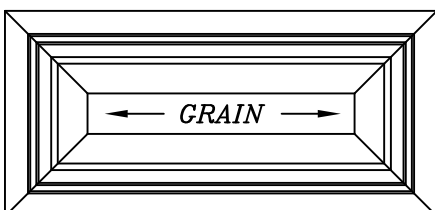

Minimum height and width available = 6 3/4"
(With a visible of 1 1/8")

Rails and stiles 2"

Mitered drawer front
Match corresponding door's edge profile,
framing bead and center panel profile

Doors

Prestige series

DOOR # 7400/?

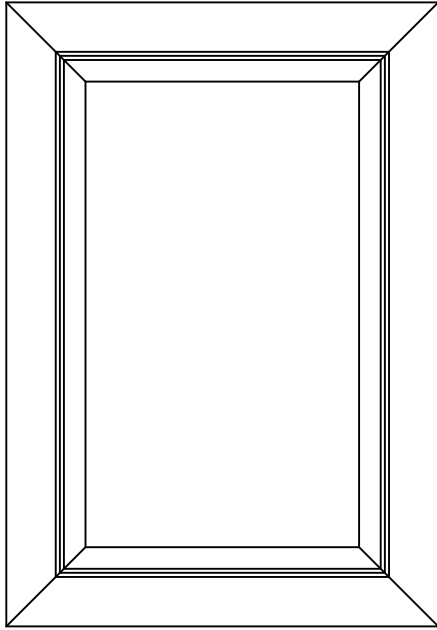

Minimum height and Width (solid) = 8 1/2"
Minimum height and width (veneer) = 7 1/2"

FRAME # 7405/?

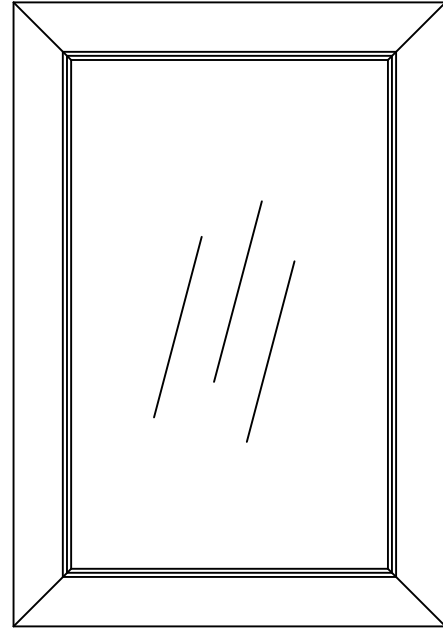

Minimum height and width = 7 1/2"

Center panel shown = P-03

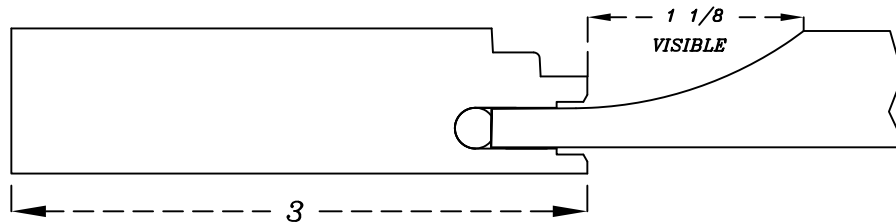

Mullion model

M011

5-PIECES DRAWER FRONT: # 7401/?

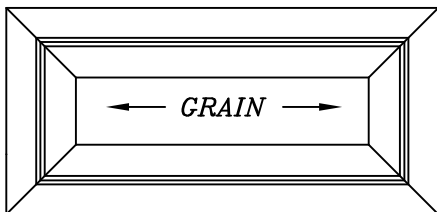

Minimum height and width available = 6 3/4"
(With a visible of 1/8")

Rails and stiles 2"

Mitered drawer front
Match corresponding door's edge profile, framing bead and center panel profile

Doors

Prestige series

DOOR # 7500/?

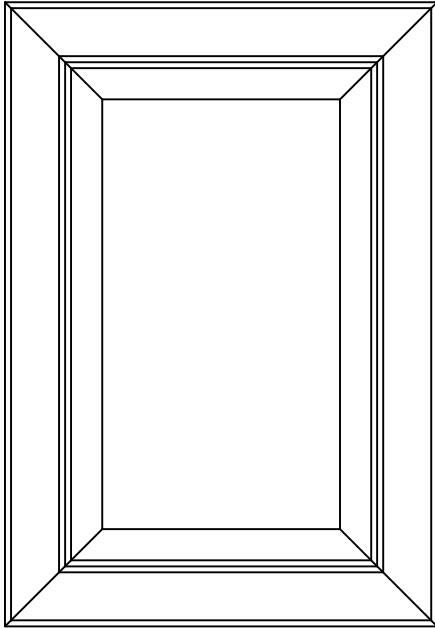

Minimum height and Width (solid) = 7 3/4"
Minimum height and width (veneer) = 6 3/4"

FRAME # 7505/?

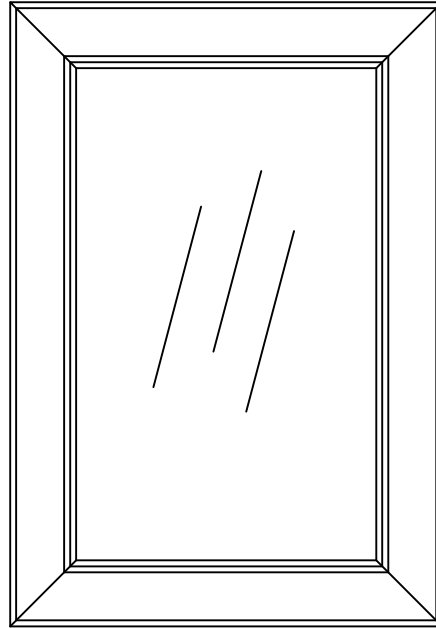

Minimum height and width = 6 3/4"

Center panel shown = P-03

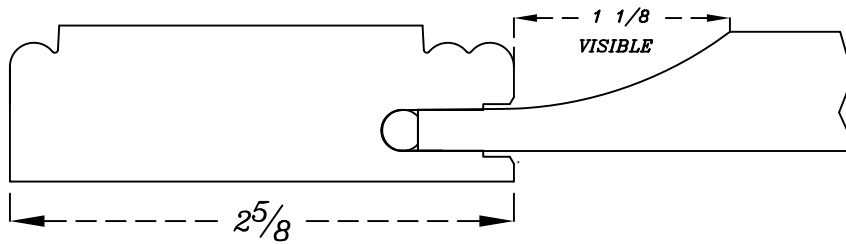

Mullion model



5-PIECES DRAWER FRONT: # 7501/?

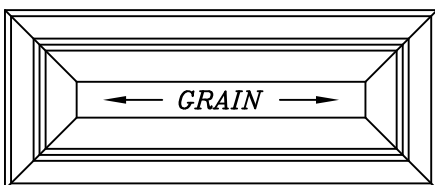

Minimum height and width available = 6 1/4"
(With a visible of 1/8")

Rails and stiles = 1 3/4"

Mitered drawer front
Match corresponding door's edge profile, framing bead and center panel profile

- 1 PROFILES
- 2 TRADITIONAL 90
- 3 DISTINCTIVE 90
- 4 CATHEDRAL 90
- 5 APPLIED MOLDINGS
- 6 PRESTIGE 45
- 7 WANSCOTS
- 8 SPECIALTY PRODUCTS
- 9 MOLDINGS
- 10 PROMOTIONAL ITEMS
- 11 POLICY

Doors

Prestige series

DOOR # 7600/?

FRAME # 7605/?

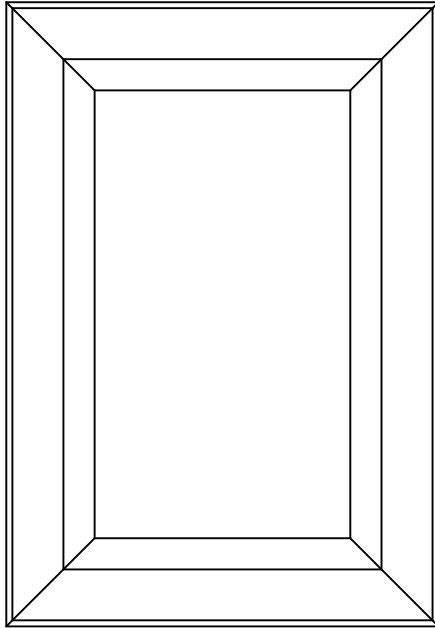

Minimum height and Width (solid) = 7"
Minimum height and width (veneer) = 6"

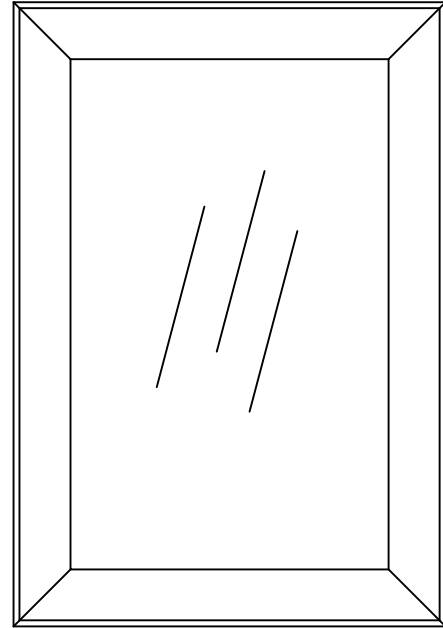

Minimum height and width = 6"

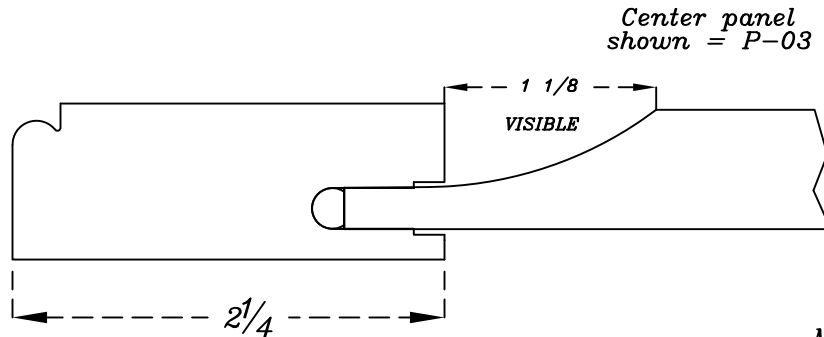

Mullion model

M011

5-PIECES DRAWER FRONT: # 7601/?

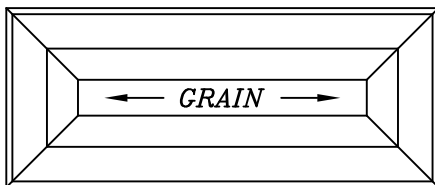

Minimum height and width available = 6 1/4"
(With a visible of 1/8")

Rails and stiles = 1 3/4"

Mitered drawer front
Match corresponding door's edge profile,
framing bead and center panel profile

Doors

Prestige series

DOOR # 7700/?

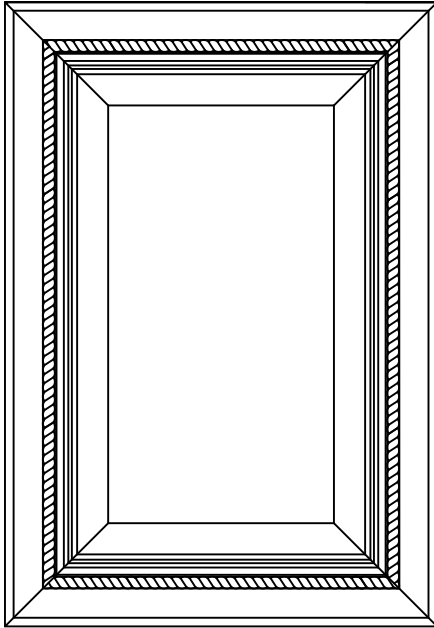

Minimum height and Width (solid) = 8 1/2"
Minimum height and width (veneer) = 7 1/2"

FRAME # 7705/?

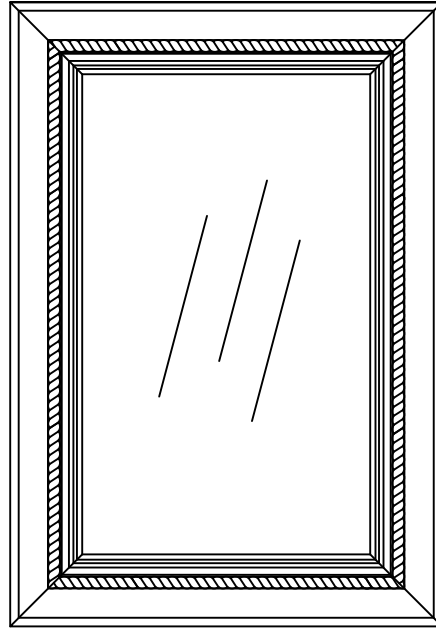

Minimum height and width = 7 1/2"

*Rope 1/2" (AM05)
 only,
 always included*

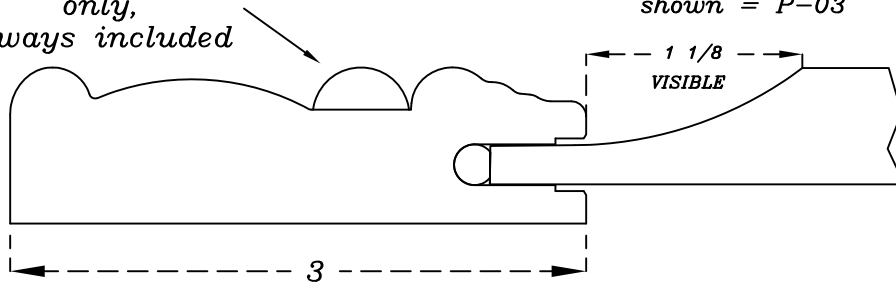

*Center panel
 shown = P-03*

Mullion model

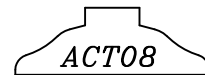

5-PIECES DRAWER FRONT: # 7701/?

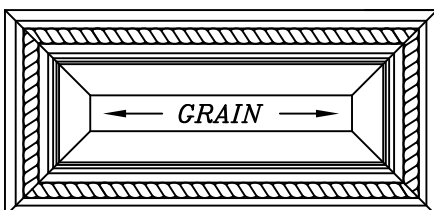

Minimum height and width available = 6 1/4"
(With a visible of 1/8")

Rails and stiles 1 3/4"

*Mitered drawer front
 Match corresponding door's edge profile,
 framing bead and center panel profile*

- 1 PROFILES
- 2 TRADITIONAL 90
- 3 DISTINCTIVE 90
- 4 CATHEDRAL 90
- 5 APPLIED MOULDINGS
- 6 PRESTIGE 45
- 7 WANSCOTS
- 8 SPECIALTY PRODUCTS
- 9 MOULDINGS
- 10 PROMOTIONAL ITEMS
- 11 POLICY

Doors

Prestige series

DOOR # 7800/?

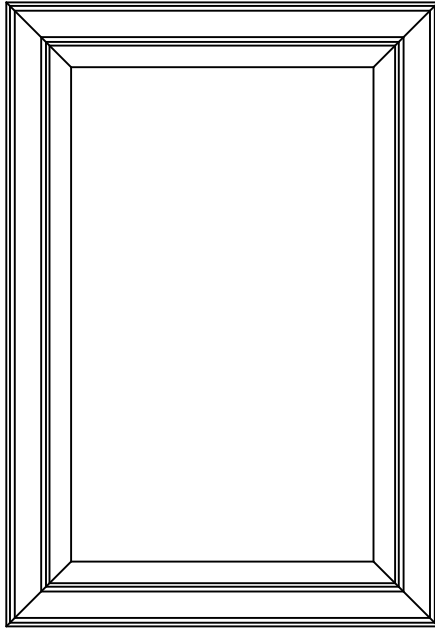

Minimum height and Width (solid) = 7"
Minimum height and width (veneer) = 6"

FRAME # 7805/?

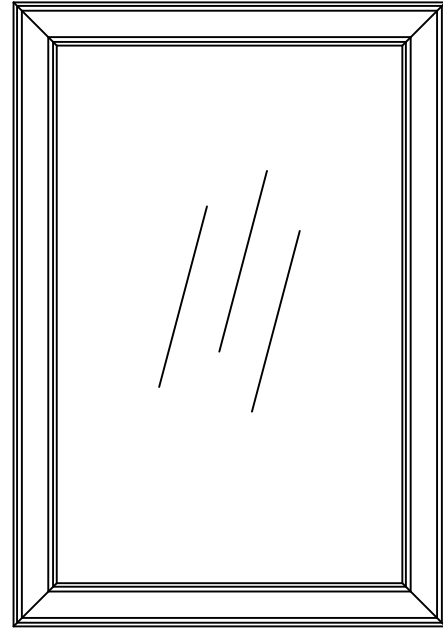

Minimum height and width = 6"

Center panel shown = P-03

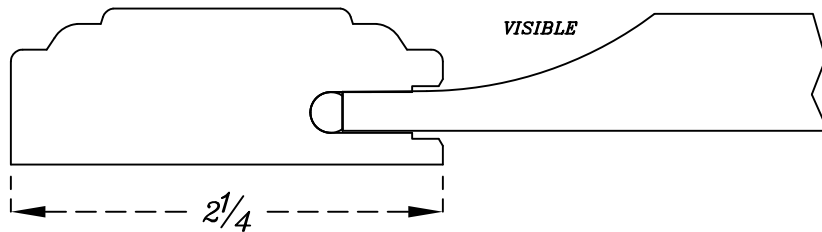

Mullion model

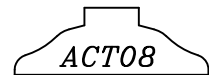

5-PIECES DRAWER FRONT: # 7801/?

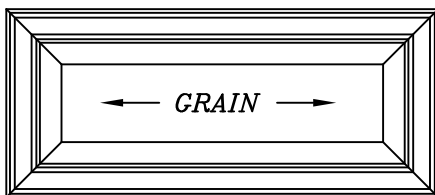

Minimum height and width available = 6 1/4"
(With a visible of 1/8")

Rails and stiles = 1 3/4"

Mitered drawer front
Match corresponding door's edge profile,
framing bead and center panel profile

Doors

Prestige series

DOOR # 7900/?

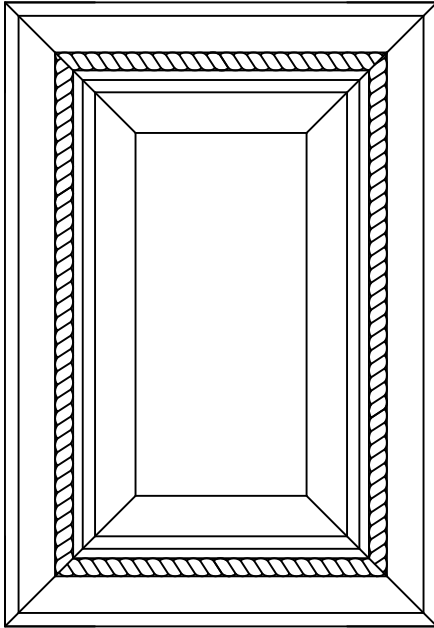

Minimum height and Width (solid) = 7 1/2"
Minimum height and width (veneer) = 6 1/2"

FRAME # 7905/?

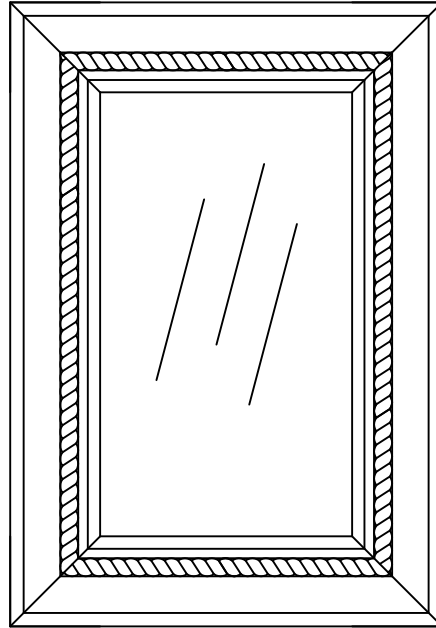

Minimum height and width = 6 1/2"

*Rope 1/2" (AM05)
 only,
 always included*

*Center panel
 shown = P-03*

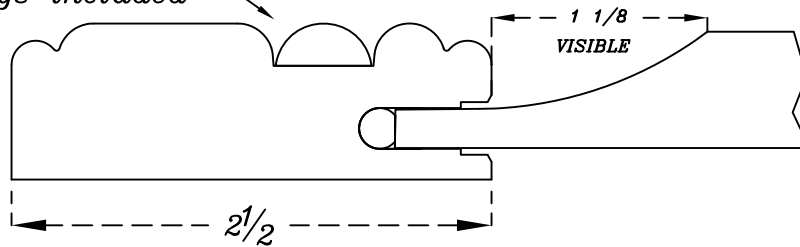

Mullion model

M053

5-PIECES DRAWER FRONT: # 7901/?

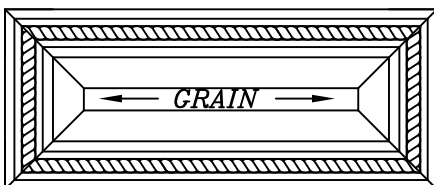

Minimum height and width available = 6 1/4"
(With a visible of 1/8")

Rails and stiles 1 3/4"

*Mitered drawer front
 Match corresponding door's edge profile,
 framing bead and center panel profile*

- 1 PROFILES
- 2 TRADITIONAL 90
- 3 DISTINCTIVE 90
- 4 CATHEDRAL 90
- 5 APPLIED MOULDINGS
- 6 PRESTIGE 45
- 7 WANSCOTS
- 8 SPECIALTY PRODUCTS
- 9 MOULDINGS
- 10 PROMOTIONAL ITEMS
- 11 POLICY

Doors

Prestige series

DOOR # 8000/?

FRAME # 8005/?

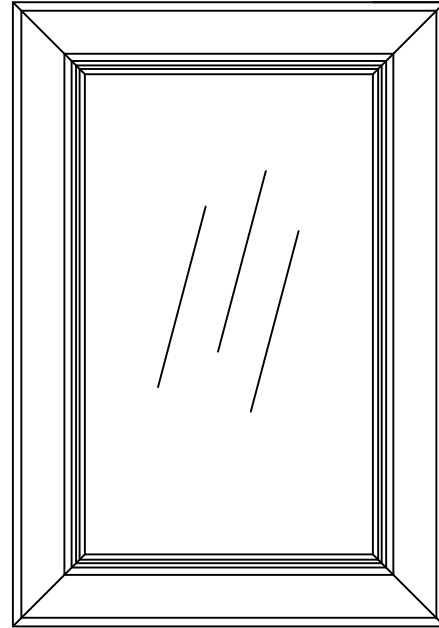
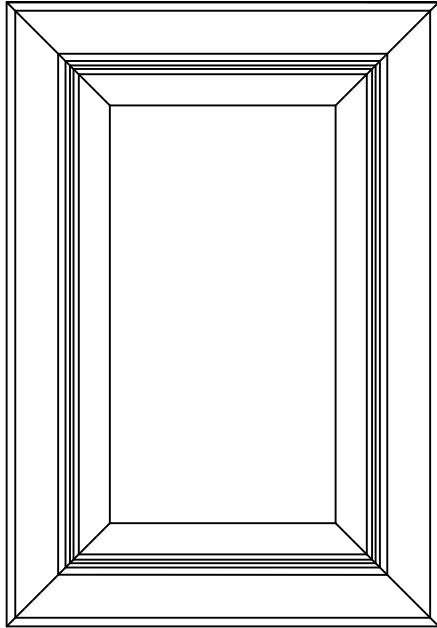

Minimum height and Width (solid) = 8 1/2"
Minimum height and width (veneer) = 7 1/2"

Minimum height and width = 7 1/2"

Center panel shown = P-03

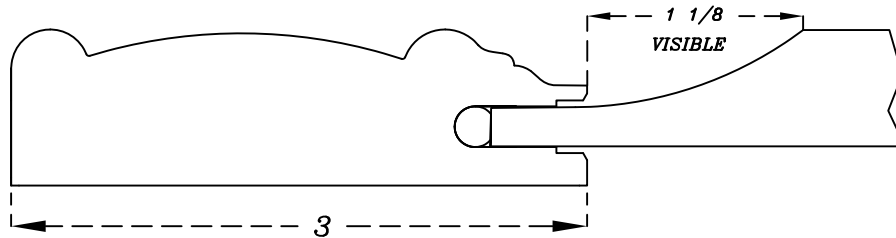

Mullion model

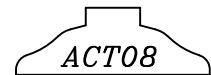

5-PIECES DRAWER FRONT: # 8001/?

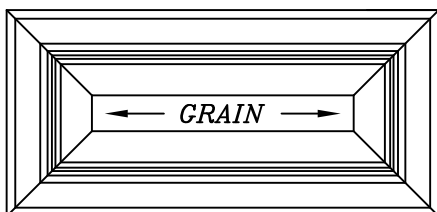

Rails and stiles 1 3/4"

Minimum height and width available = 6 1/4"
(With a visible of 1/8")

Mitered drawer front
Match corresponding door's edge profile,
framing bead and center panel profile

Doors

Prestige series

- 1 PROFILES
- 2 TRADITIONAL 90
- 3 DISTINCTIVE 90
- 4 CATHEDRAL 90
- 5 APPLIED MOULDINGS
- 6 PRESTIGE 45
- 7 WANSCOTS
- 8 SPECIALTY PRODUCTS
- 9 MOULDINGS
- 10 PROMOTIONAL ITEMS
- 11 POLICY

DOOR # 8100/?

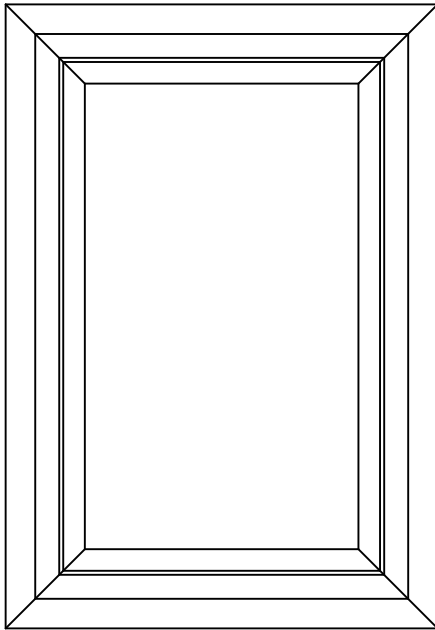

Minimum height and Width (solid) = 8 1/2"
Minimum height and width (veneer) = 7 1/2"

FRAME # 8105/?

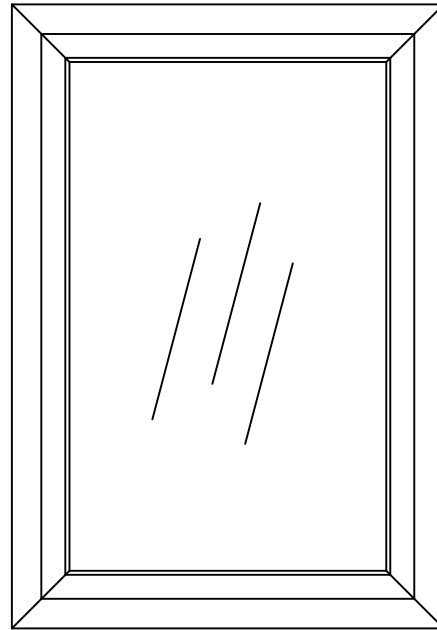

Minimum height and width = 7 1/2"

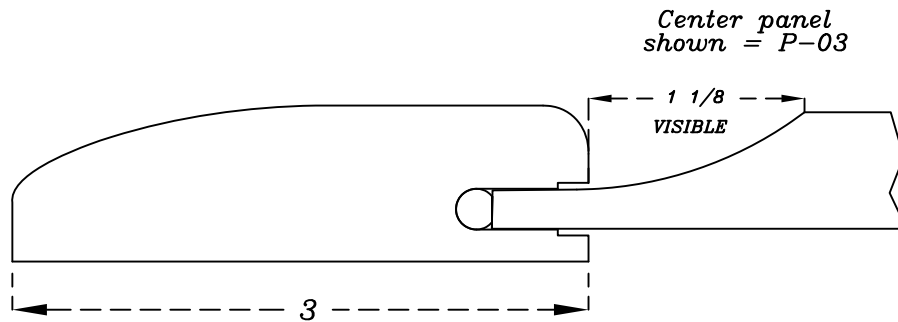

Center panel shown = P-03

Mullion model

M053

5-PIECES DRAWER FRONT: # 8101/?

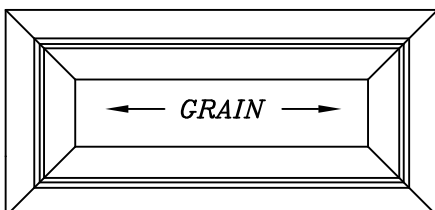

Minimum height and width available = 6 3/4"
(With a visible of 1/8")

Rails and stiles 2"

Mitered drawer front
Match corresponding door's edge profile, framing bead and center panel profile

Doors

Prestige series

DOOR # 8200/?

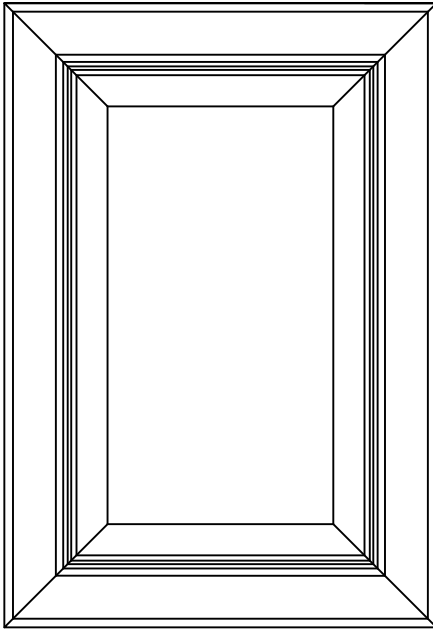

Minimum height and Width (solid) = 8 1/2"
Minimum height and width (veneer) = 7 1/2"

FRAME # 8205/?

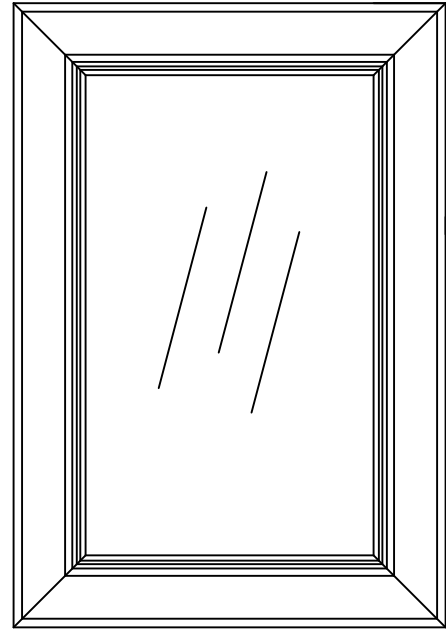

Minimum height and width = 7 1/2"

Center panel shown = P-03

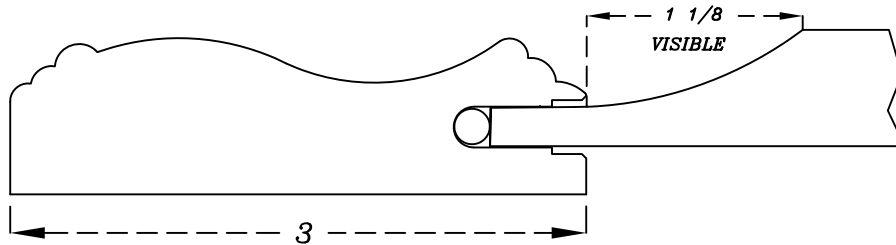

Mullion model

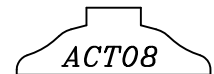

5-PIECE DRAWER FRONT: # 8201/?

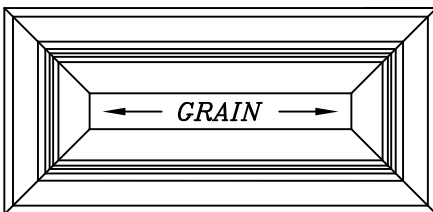

Minimum height and width available = 5 3/4"
(With a visible of 1/8")

Standard rails and stiles 1 1/2"
Optional rails and stiles 2"

If the option 2 " is not specified, front will be produced at 1 1/2 "

Mitered drawer front matches framing bead and center panel profile

Doors

Prestige series

- 1 PROFILES
- 2 TRADITIONAL 90
- 3 DISTINCTIVE 90
- 4 CATHEDRAL 90
- 5 APPLIED MOULDINGS
- 6 PRESTIGE 45
- 7 WANSCOOTS
- 8 SPECIALTY PRODUCTS
- 9 MOULDINGS
- 10 PROMOTIONAL ITEMS
- 11 POLICY

DOOR # 8300/?

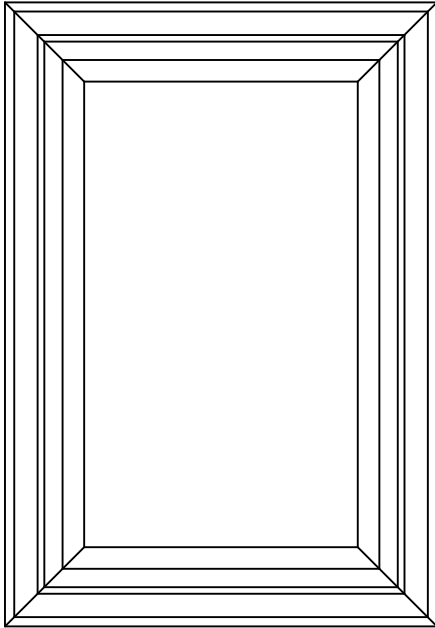

Minimum height and Width (solid) = 8 1/2"
Minimum height and width (veneer) = 7 1/2"

FRAME # 8305/?

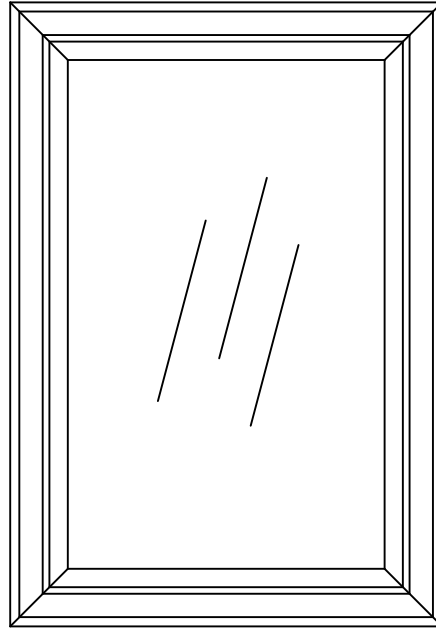

Minimum height and width = 7 1/2"

Center panel shown = P-03

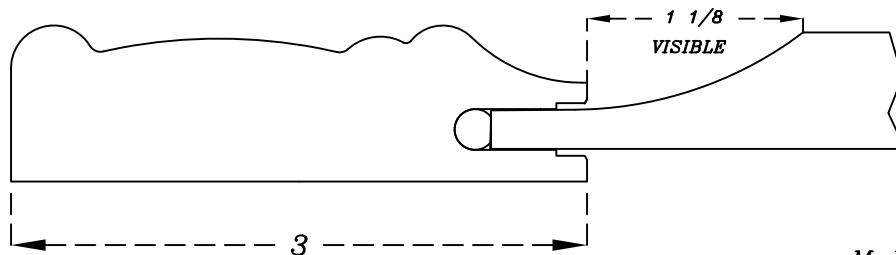

Mullion model

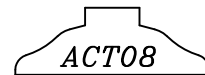

5-PIECES DRAWER FRONT: # 8301/?

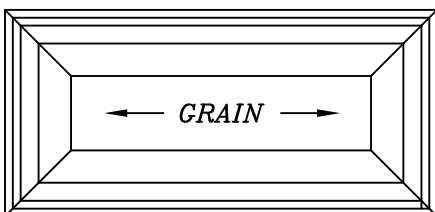

Minimum height and width available = 6 1/4"
(With a visible of 1/8")

Rails and stiles = 1 3/4"

Mitered drawer front
Match corresponding door's edge profile, framing bead and center panel profile

Doors

Prestige series

DOOR # 8400/?

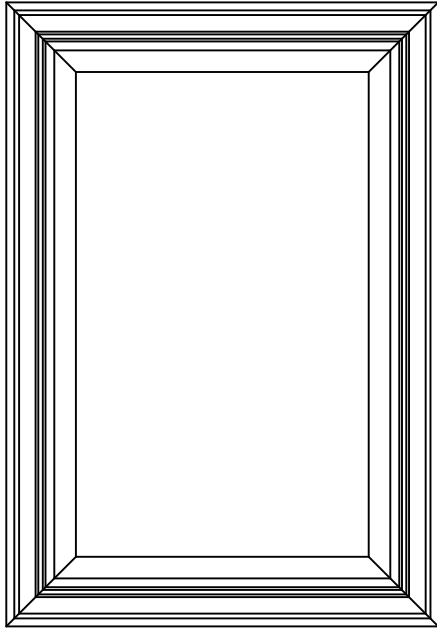

Minimum height and Width (solid) = 7 1/2"
Minimum height and width (veneer) = 6 1/2"

FRAME # 8405/?

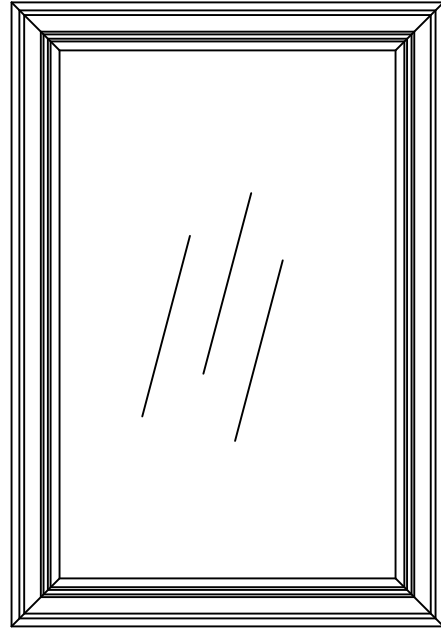

Minimum height and width = 6 1/2"

Center panel shown = P-03

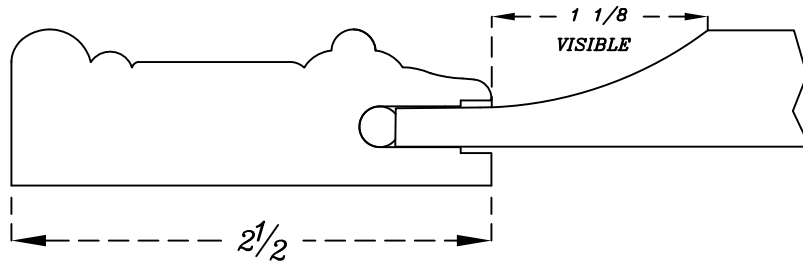

Mullion model

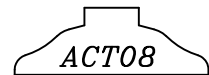

5-PIECES DRAWER FRONT: # 8401/?

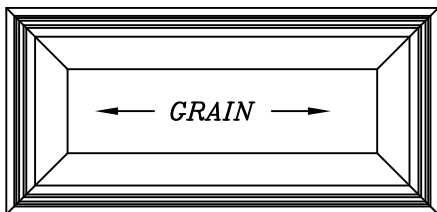

Minimum height and width available = 5 3/4"
(With a visible of 1/8")

Rails and stiles = 1 1/2"

Mitered drawer front
Match corresponding door's edge profile,
framing bead and center panel profile

Doors

Prestige series

- 1 PROFILES
- 2 TRADITIONAL 90
- 3 DISTINCTIVE 90
- 4 CATHEDRAL 90
- 5 APPLIED MOULDINGS
- 6 PRESTIGE 45
- 7 WANSCOTS
- 8 SPECIALTY PRODUCTS
- 9 MOULDINGS
- 10 PROMOTIONAL ITEMS
- 11 POLICY

DOOR # 8500/?

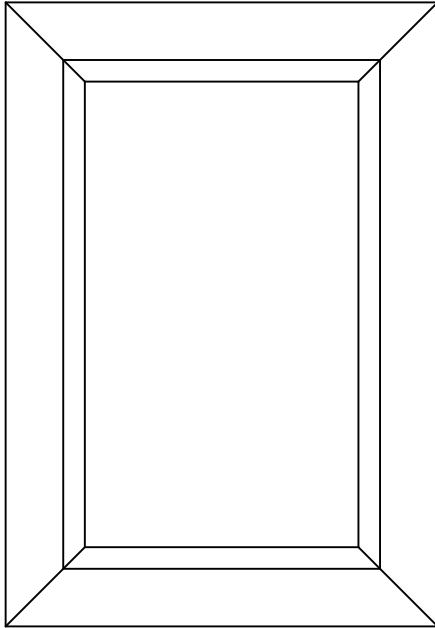

Minimum height and Width (solid) = 8 1/2"
Minimum height and width (veneer) = 7 1/2"

FRAME # 8505/?

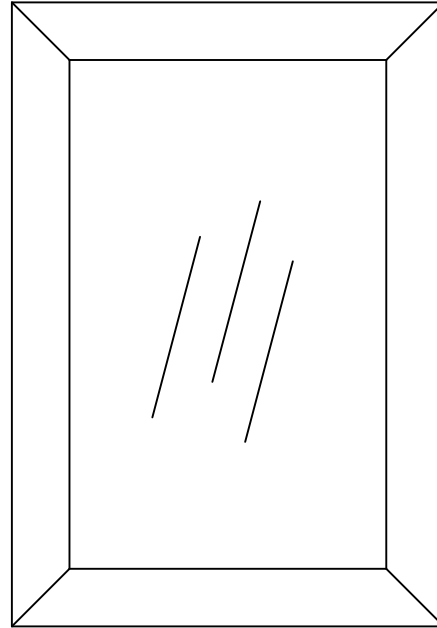

Minimum height and width = 7 1/2"

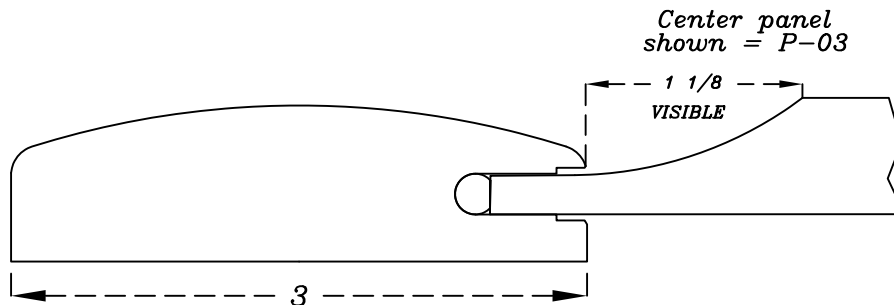

Mullion model

M053

5-PIECES DRAWER FRONT: # 8501/?

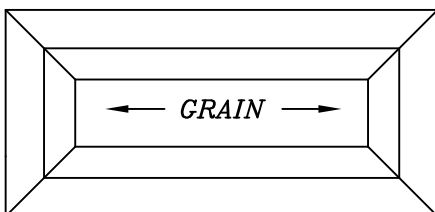

Minimum height and width available = 6 3/4"
(With a visible of 1/8")

Rails and stiles 2"

Mitered drawer front
Match corresponding door's edge profile,
framing bead and center panel profile

Doors

Prestige series

DOOR # 8600/?

FRAME # 8605/?

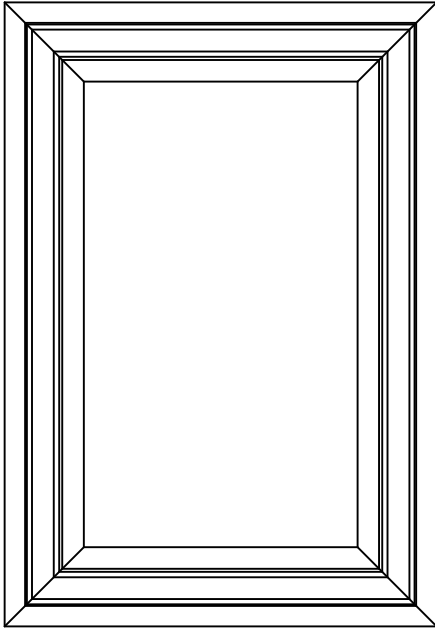

Minimum height and Width (solid) = 8 1/2"
Minimum height and width (veneer) = 7 1/2"

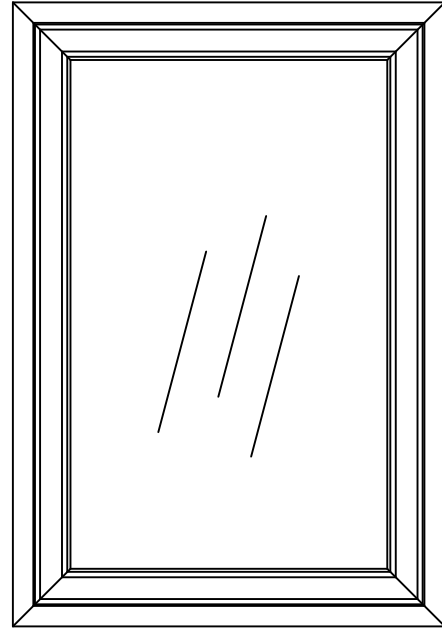

Minimum height and width = 7 1/2"

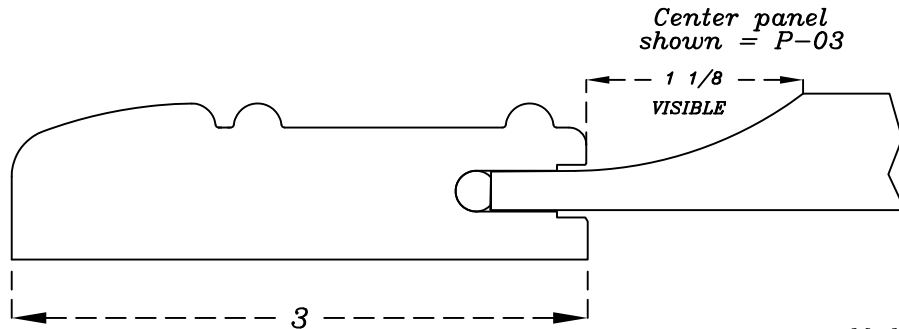

Mullion model

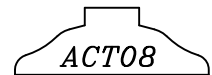

5-PIECES DRAWER FRONT: # 8601/?

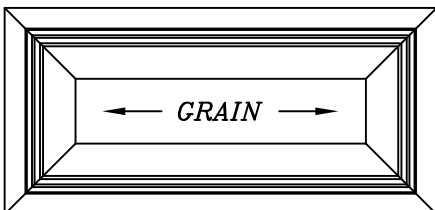

Minimum height and width available = 6 3/4"
(With a visible of 1/8")

Rails and stiles 2"

Mitered drawer front
Match corresponding door's edge profile,
framing bead and center panel profile

Doors

Prestige series

- 1 PROFILES
- 2 TRADITIONAL 90
- 3 DISTINCTIVE 90
- 4 CATHEDRAL 90
- 5 APPLIED MOULDINGS
- 6 PRESTIGE 45
- 7 WANSCOTS
- 8 SPECIALTY PRODUCTS
- 9 MOULDINGS
- 10 PROMOTIONAL ITEMS
- 11 POLICY

DOOR # 8700/?

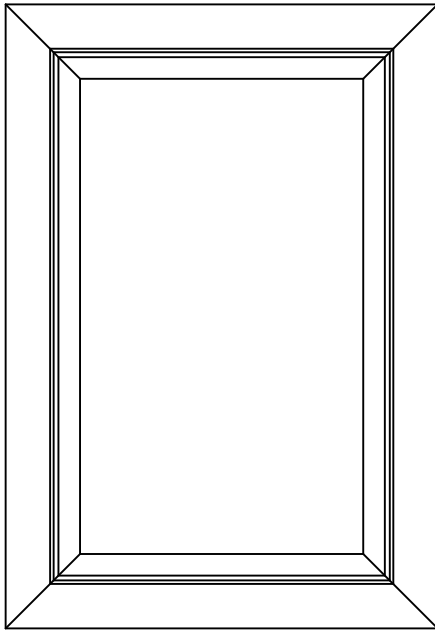

*Minimum height and Width (solid) = 8"
Minimum height and width (veneer) = 7"*

FRAME # 8705/?

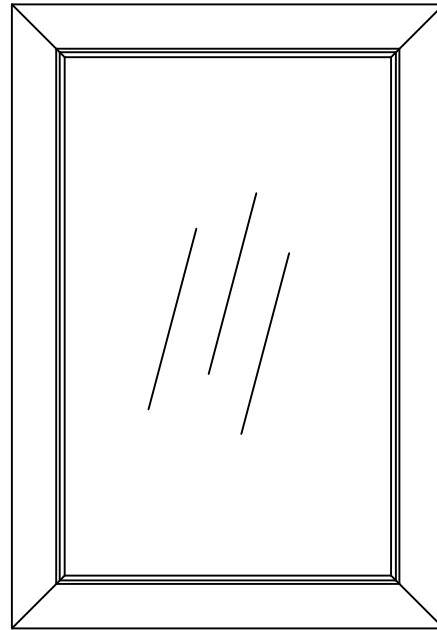

Minimum height and width = 7"

Center panel shown = P-03

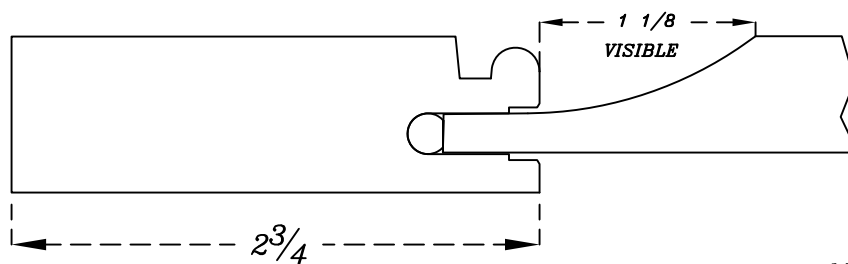

Mullion model

M053

5-PIECES DRAWER FRONT: # 8701/?

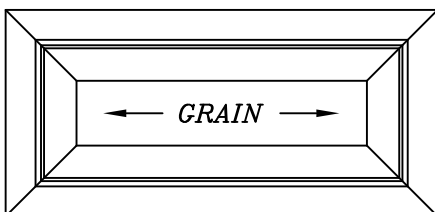

*Minimum height and width available = 6 1/4"
(With a visible of 1/8")*

Rails and stiles 1 3/4"

*Mitered drawer front
Match corresponding door's edge profile,
framing bead and center panel profile*

1 PROFILES
 2 TRADITIONAL 90
 3 DISTINCTIVE 90
 4 CATHEDRAL 90
 5 APPLIED MOULDINGS
 6 PRESTIGE 45
 7 WAINSCOTS
 8 SPECIALITY PRODUCTS
 9 MOULDINGS
 10 PROMOTIONAL ITEMS
 11 POLICY

Doors

Prestige series

DOOR # 8800/?

FRAME # 8805/?

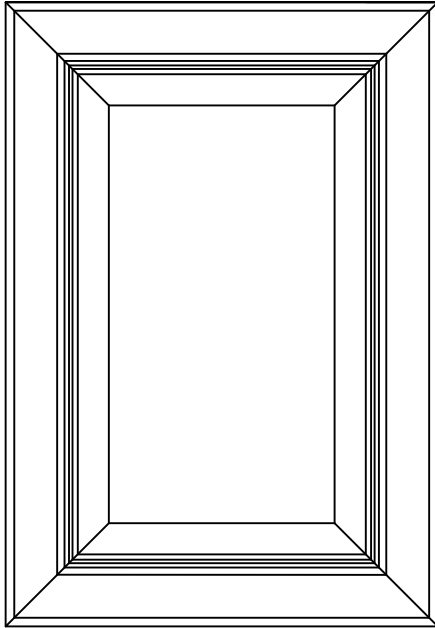

Minimum height and Width (solid) = 8 1/4"
Minimum height and width (veneer) = 7 1/4"

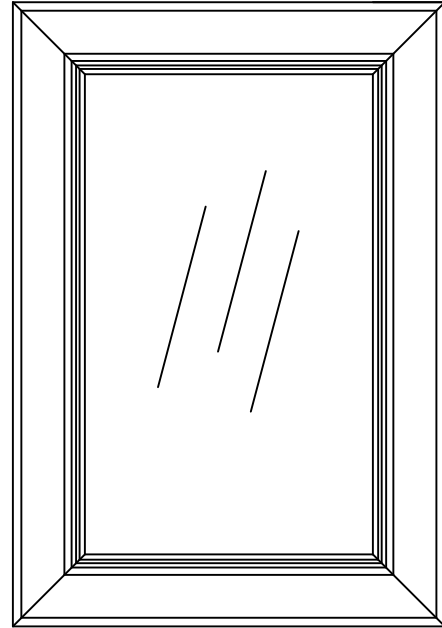

Minimum height and width = 7 1/4"

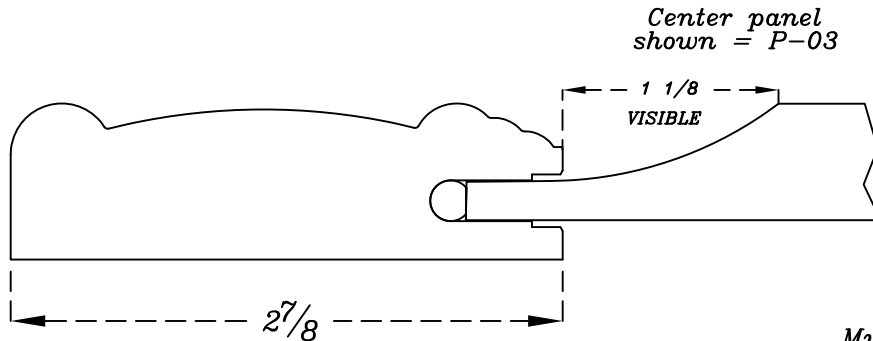

Mullion model

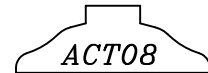

5-PIECES DRAWER FRONT: # 8801/?

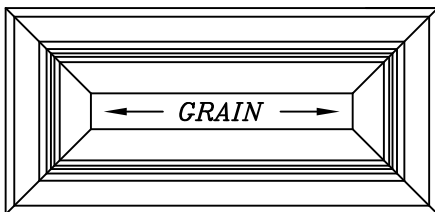

Minimum height and width available = 6 5/8"
(With a visible of 1/8")

Rails and stiles 1 15/16"

Mitered drawer front
Match corresponding door's edge profile,
framing bead and center panel profile

Doors

Prestige series

- 1 PROFILES
- 2 TRADITIONAL 90
- 3 DISTINCTIVE 90
- 4 CATHEDRAL 90
- 5 APPLIED MOULDINGS
- 6 PRESTIGE 45
- 7 WANSCOOTS
- 8 SPECIALTY PRODUCTS
- 9 MOULDINGS
- 10 PROMOTIONAL ITEMS
- 11 POLICY

DOOR # 8900/?

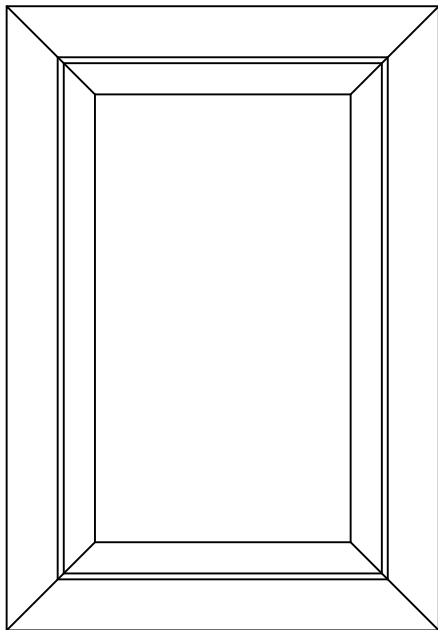

Minimum height and Width (solid) = 8 1/2"
Minimum height and width (veneer) = 7 1/2"

FRAME # 8905/?

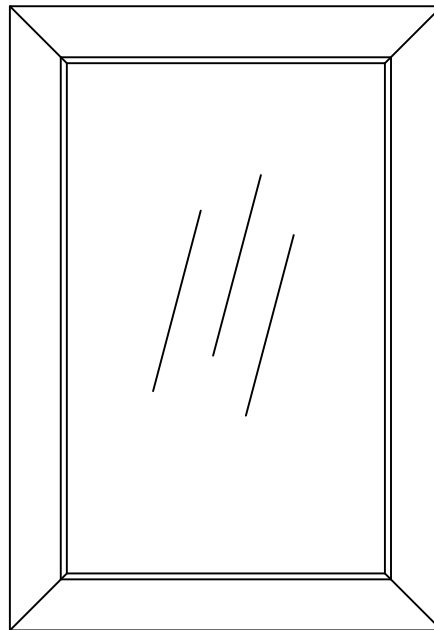

Minimum height and width = 7 1/2"

Center panel shown = P-03

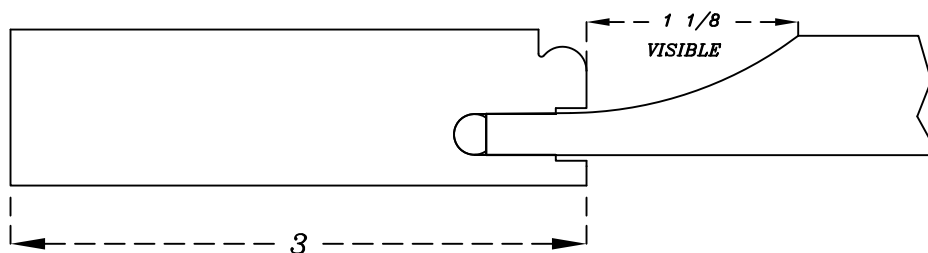

Mullion model

M053

5-PIECES DRAWER FRONT: # 8901/?

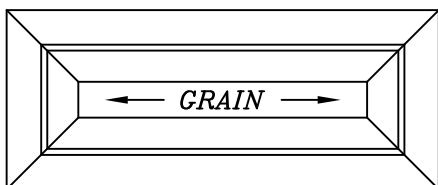

Minimum height and width available = 6 1/4"
(With a visible of 1/8")

Rails and stiles = 1 3/4"

Mitered drawer front
Match corresponding door's edge profile, framing bead and center panel profile

Doors

Prestige series

DOOR # 9000/?

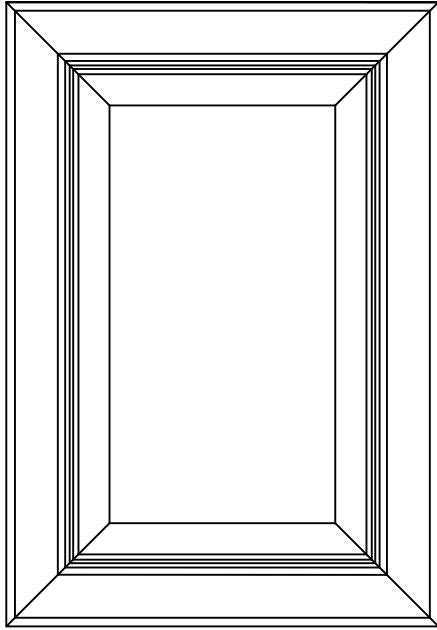

Minimum height and Width (solid) = 8 1/2"
Minimum height and width (veneer) = 7 1/2"

FRAME # 9005/?

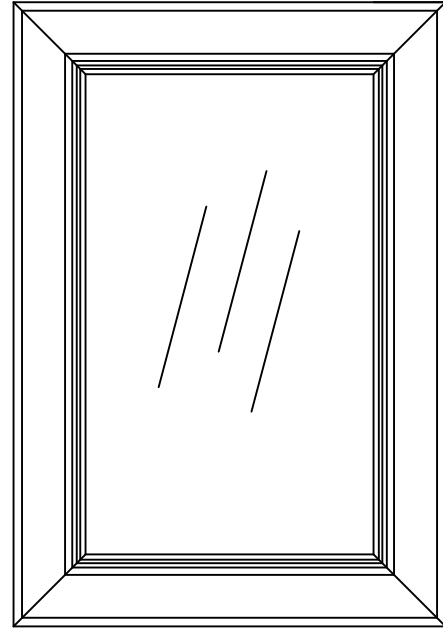

Minimum height and width = 7 1/2"

Center panel shown = P-03

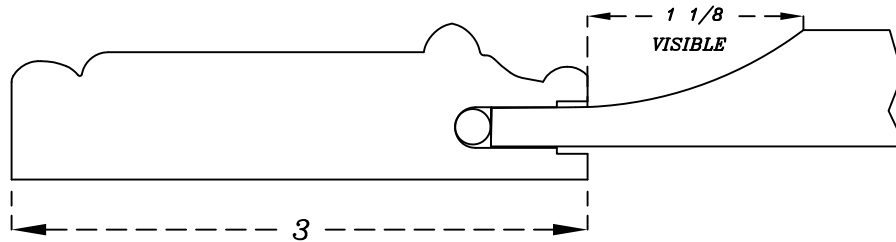

Mullion model

M053

5-PIECES DRAWER FRONT: # 9001/?

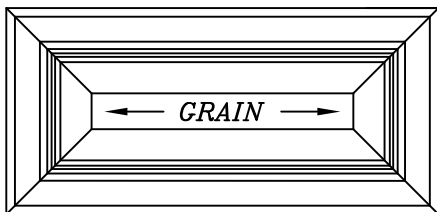

Minimum height and width available = 7 1/4"
(With a visible of 1 1/8")

Rails and stiles 2 1/4"

Mitered drawer front
Match corresponding door's edge profile, framing bead and center panel profile

Doors

Prestige series

- 1 PROFILES
- 2 TRADITIONAL 90
- 3 DISTINCTIVE 90
- 4 CATHEDRAL 90
- 5 APPLIED MOULDINGS
- 6 PRESTIGE 45
- 7 WANNSCOTS
- 8 SPECIALTY PRODUCTS
- 9 MOULDINGS
- 10 PROMOTIONAL ITEMS
- 11 POLICY

DOOR # 9100/?

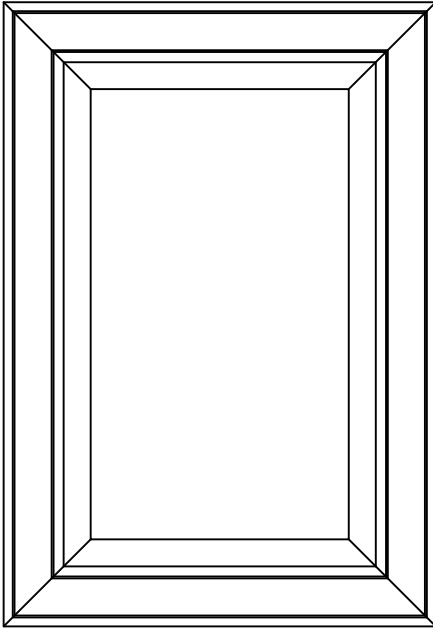

Minimum height and Width (solid) = 7 1/2"
Minimum height and width (veneer) = 6 1/2"

FRAME # 9105/?

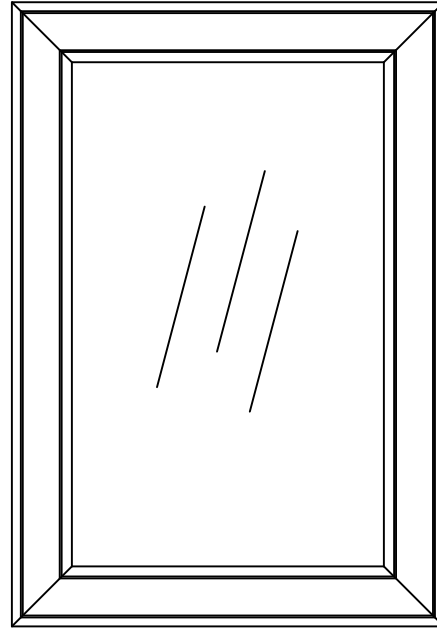

Minimum height and width = 6 1/2"

Center panel shown = P-03

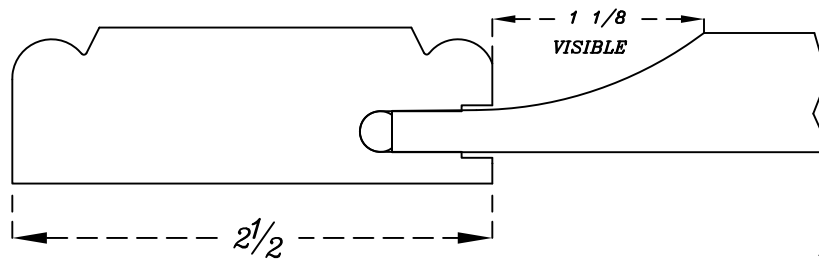

Mullion model

M053

5-PIECES DRAWER FRONT: # 9101/?

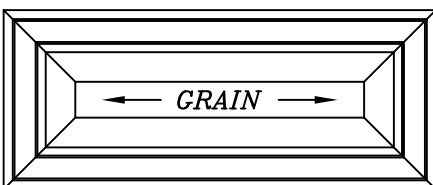

Minimum height and width available = 6 1/4"
(With a visible of 1/8")

Rails and stiles = 1 3/4"

Mitered drawer front
Match corresponding door's edge profile, framing bead and center panel profile

1 PROFILES
 2 TRADITIONAL 90
 3 DISTINCTIVE 90
 4 CATHEDRAL 90
 5 APPLIED MOULDINGS
 6 PRESTIGE 45
 7 WAINSCOTS
 8 SPECIALITY PRODUCTS
 9 MOULDINGS
 10 PROMOTIONAL ITEMS
 11 POLICY

Doors

Prestige series

DOOR # 9200/?

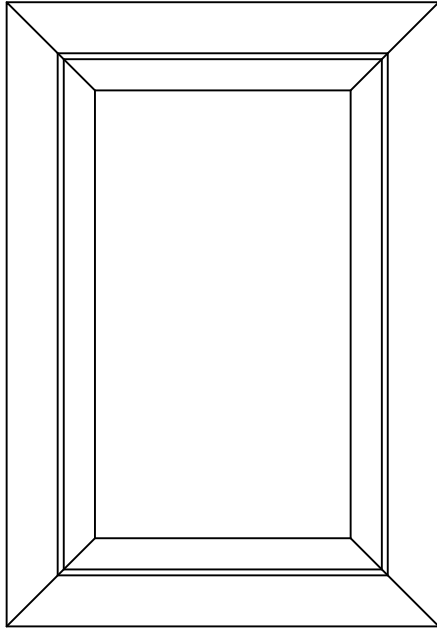

Minimum height and Width (solid) = 7"
 Minimum height and width (veneer) = 6"

FRAME # 9205/?

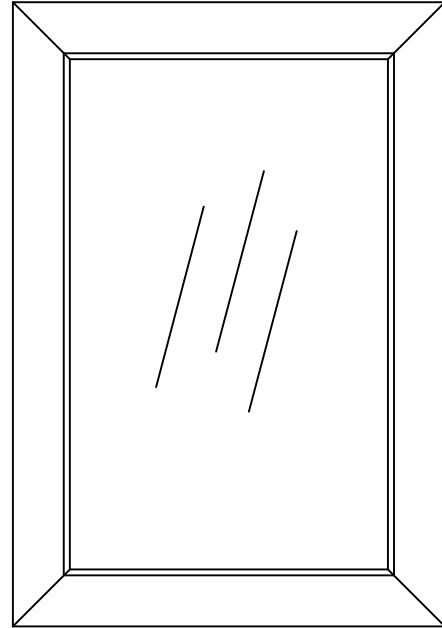

Minimum height and width = 6"

Center panel shown = P-03

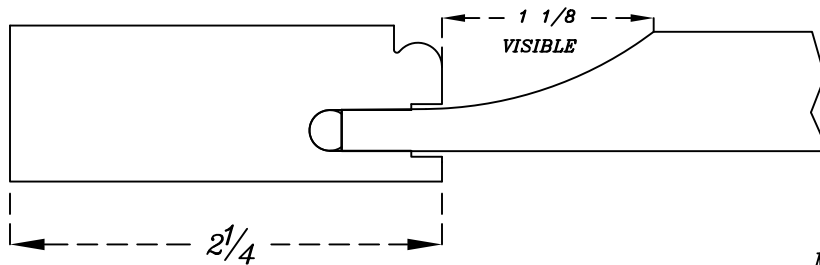

Mullion model

M053

5-PIECES DRAWER FRONT: # 9201/?

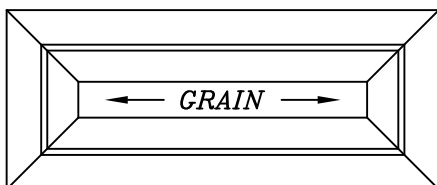

Minimum height and width available = 6 1/4"
 (With a visible of 1/8")

Rails and stiles = 1 3/4"

Mitered drawer front
 Match corresponding door's edge profile,
 framing bead and center panel profile

Doors

Prestige series

- 1 PROFILES
- 2 TRADITIONAL 90
- 3 DISTINCTIVE 90
- 4 CATHEDRAL 90
- 5 APPLIED MOULDINGS
- 6 PRESTIGE 45
- 7 WANSCOTS
- 8 SPECIALTY PRODUCTS
- 9 MOULDINGS
- 10 PROMOTIONAL ITEMS
- 11 POLICY

DOOR # 9300/?

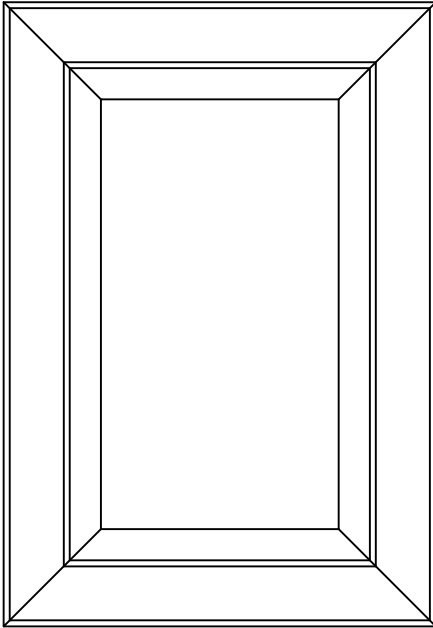

Minimum height and Width (solid) = 7 3/4"
Minimum height and width (veneer) = 6 3/4"

FRAME # 9305/?

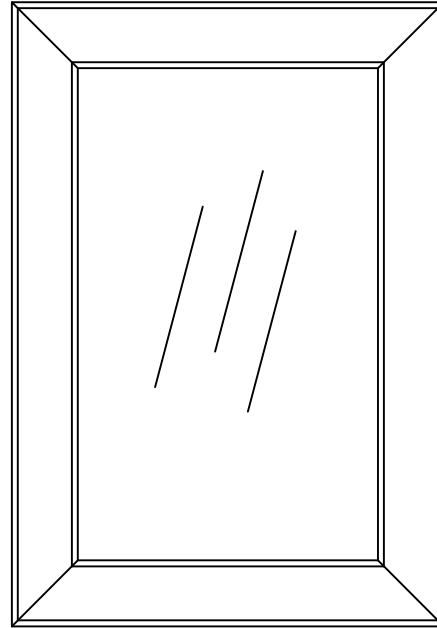

Minimum height and width = 6 3/4"

Center panel shown = P-03

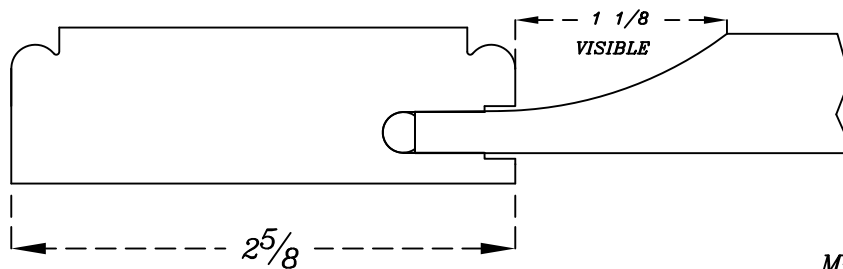

Mullion model

M053

5-PIECES DRAWER FRONT: # 9301/?

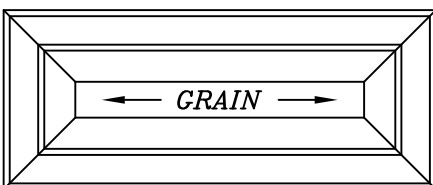

Minimum height and width available = 6 1/4"
(With a visible of 1/8")

Rails and stiles = 1 3/4"

Mitered drawer front
Match corresponding door's edge profile, framing bead and center panel profile

Doors

Prestige series

DOOR # 9400/?

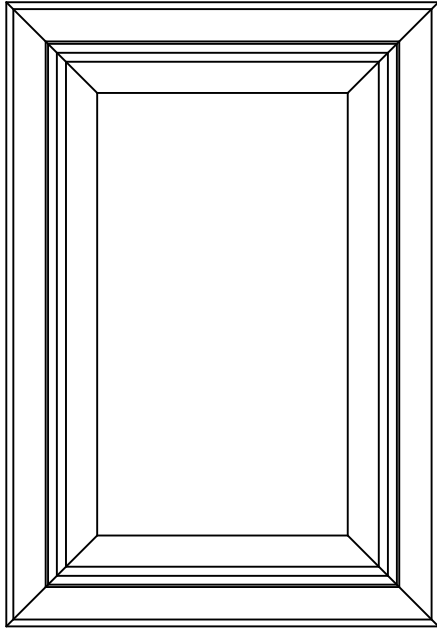

Minimum height and Width (solid) = 7 1/2"
Minimum height and width (veneer) = 6 1/2"

FRAME # 9405/?

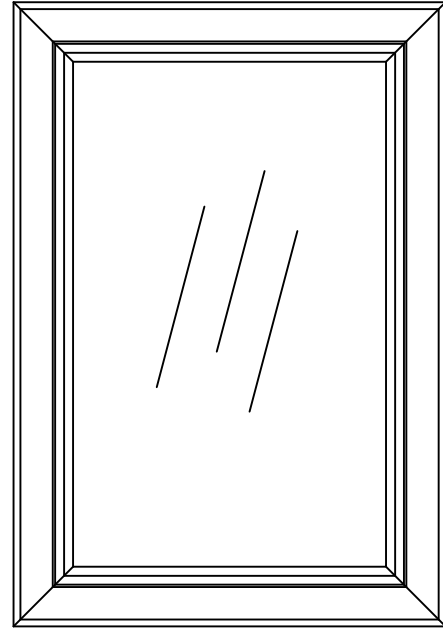

Minimum height and width = 6 1/2"

Center panel shown = P-03

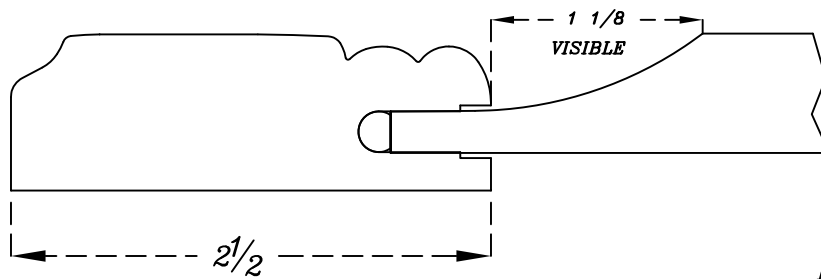

Mullion model

M053

5-PIECES DRAWER FRONT: # 9401/?

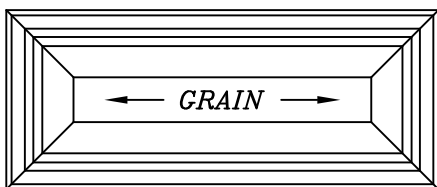

Minimum height and width available = 5 3/4"
(With a visible of 1/8")

Rails and stiles = 1 1/2"

Mitered drawer front
Match corresponding door's edge profile,
framing bead and center panel profile

Doors

Prestige series

DOOR # 9500/?

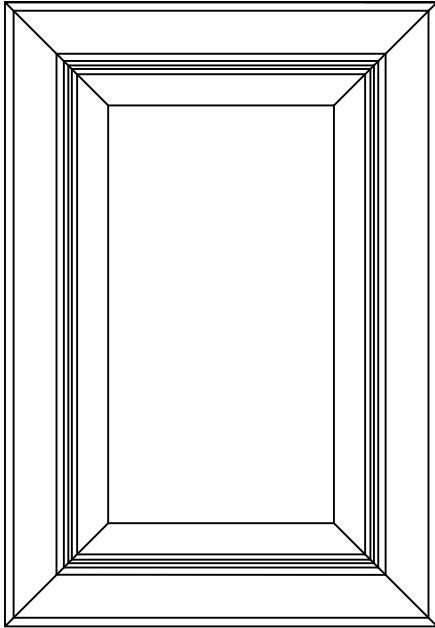

Minimum height and Width (solid) = 8 1/2"
Minimum height and width (veneer) = 7 1/2"

FRAME # 9505/?

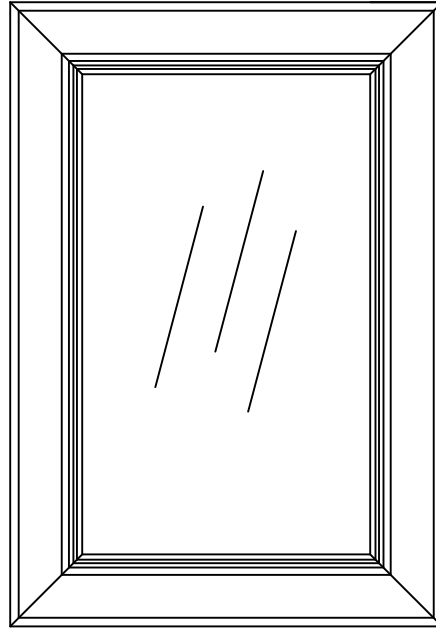

Minimum height and width = 7 1/2"

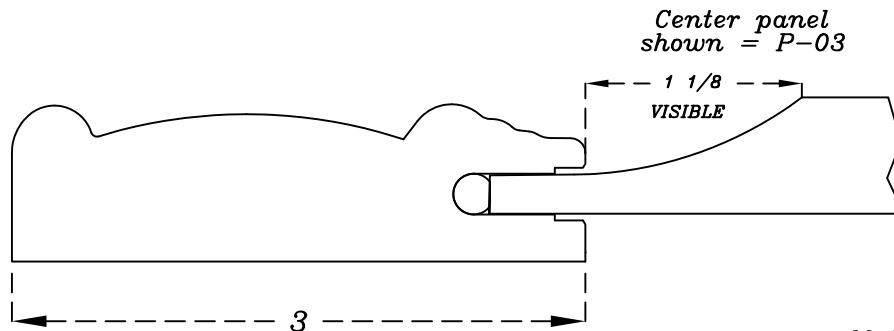

Mullion model

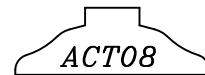

5-PIECES DRAWER FRONT: # 9501/?

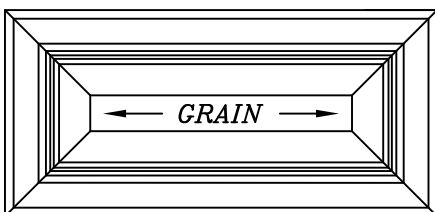

Minimum height and width available = 6 1/4"
(With a visible of 1 1/8")

Rails and stiles 1 3/4"

Mitered drawer front
Match corresponding door's edge profile,
framing bead and center panel profile

- 1 PROFILES
- 2 TRADITIONAL 90
- 3 DISTINCTIVE 90
- 4 CATHEDRAL 90
- 5 APPLIED MOULDINGS
- 6 PRESTIGE 45
- 7 WANSCOTS
- 8 SPECIALTY PRODUCTS
- 9 MOULDINGS
- 10 PROMOTIONAL ITEMS
- 11 POLICY

Doors

Prestige series

DOOR # 9600/?

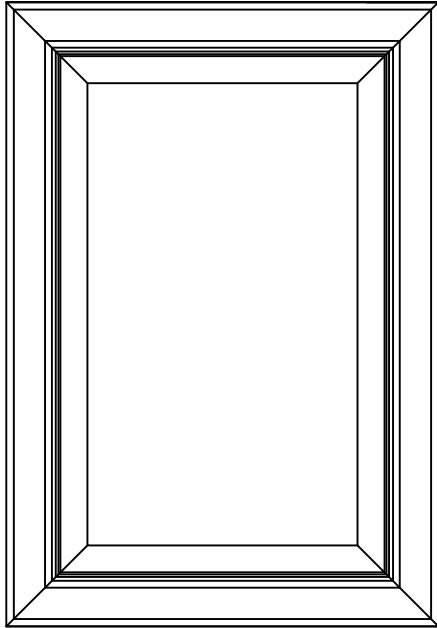

Minimum height and Width (solid) = 7"
Minimum height and width (veneer) = 6"

FRAME # 9605/?

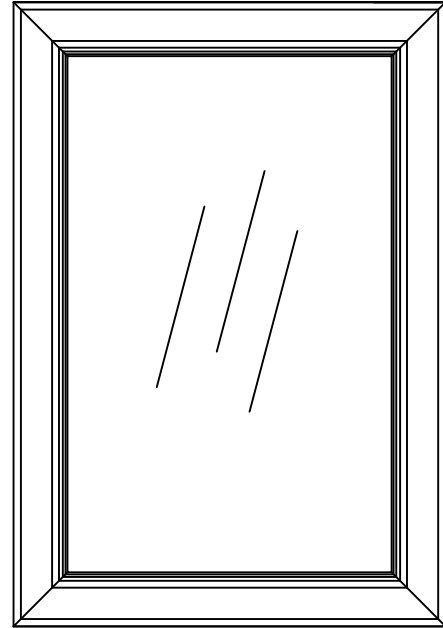

Minimum height and width = 6"

Center panel shown = P-03

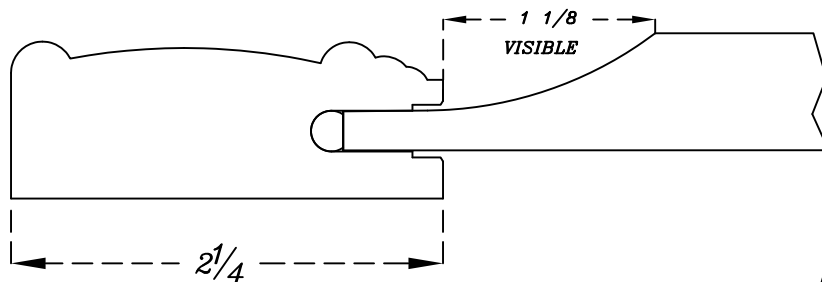

Mullion model

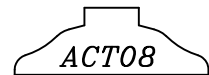

5-PIECES DRAWER FRONT: # 9601/?

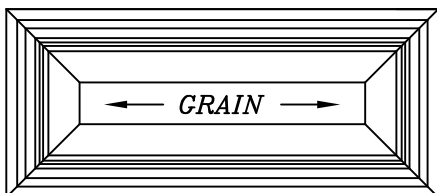

Minimum height and width available = 6 1/4"
(With a visible of 1/8")

Rails and stiles = 1 3/4"

Mitered drawer front
Match corresponding door's edge profile,
framing bead and center panel profile

Doors

Prestige series

- 1 PROFILES
- 2 TRADITIONAL 90
- 3 DISTINCTIVE 90
- 4 CATHEDRAL 90
- 5 APPLIED MOULDINGS
- 6 PRESTIGE 45
- 7 WANSCOTS
- 8 SPECIALTY PRODUCTS
- 9 MOULDINGS
- 10 PROMOTIONAL ITEMS
- 11 POLICY

DOOR # 9700/?

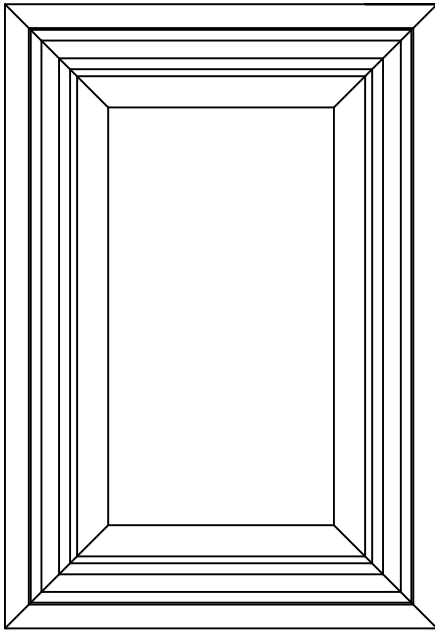

Minimum height and Width (solid) = 8 1/2"
Minimum height and width (veneer) = 7 1/2"

FRAME # 9705/?

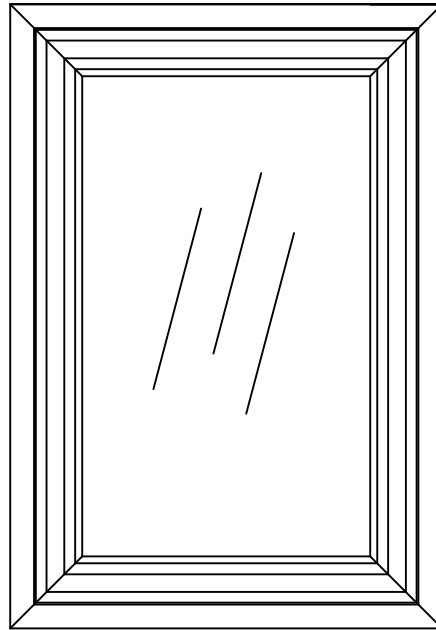

Minimum height and width = 7 1/2"

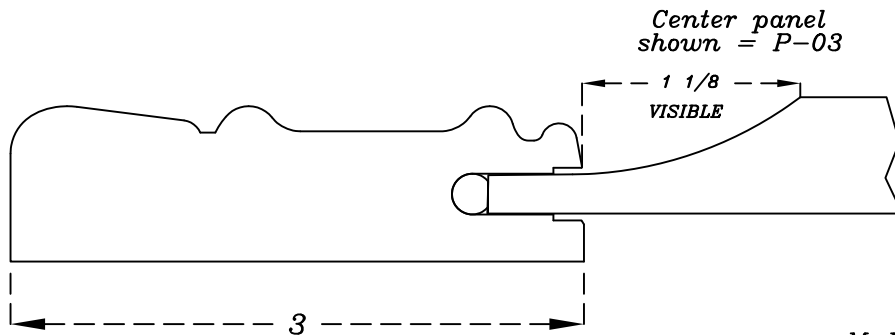

Mullion model

M053

5-PIECES DRAWER FRONT: # 9701/?

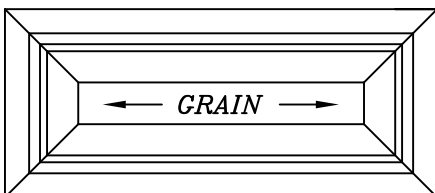

Minimum height and width available = 6 1/4"
(With a visible of 1/8")

Rails and stiles 1 3/4"

Mitered drawer front
Match corresponding door's edge profile,
framing bead and center panel profile

DOOR # 9800/?

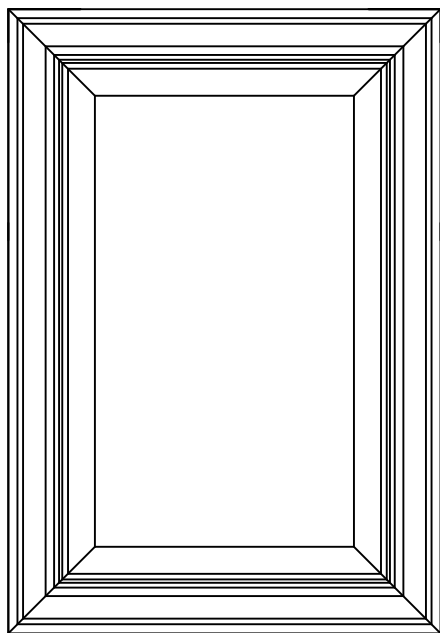

Minimum height and Width (solid) = 7 1/2"
Minimum height and width (veneer) = 6 1/2"

FRAME # 9805/?

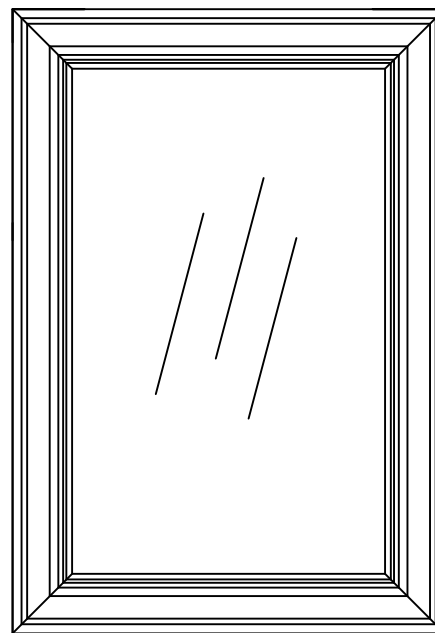

Minimum height and width = 6 1/2"

Center panel shown = P-03

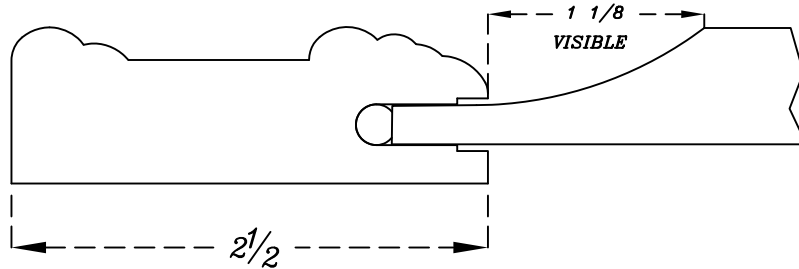

Mullion model

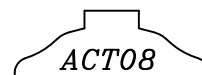

5-PIECE DRAWER FRONT: # 9801/?

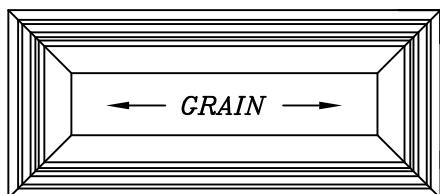

Minimum height and width available = 5 3/4"
(With a visible of 1/8")

Standard rails and stiles 1 1/2"
Optional rails and stiles 2"

If the option 2 " is not specified, front will be produced at 1 1/2 "

Mitered drawer front matches framing bead and center panel profile

Doors

Prestige series

DOOR # 9900/?

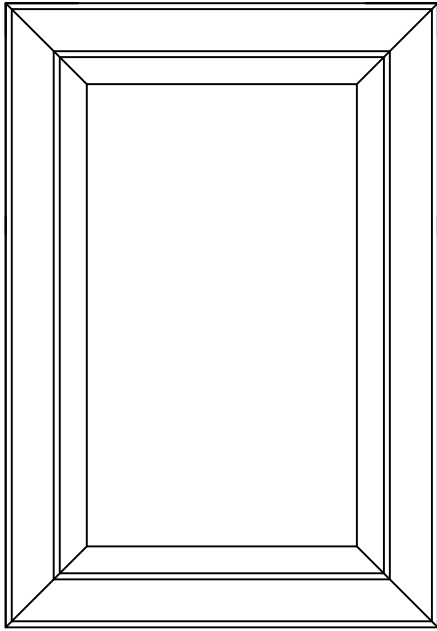

Minimum height and Width (solid) = 7"
Minimum height and width (veneer) = 6"

FRAME # 9905/?

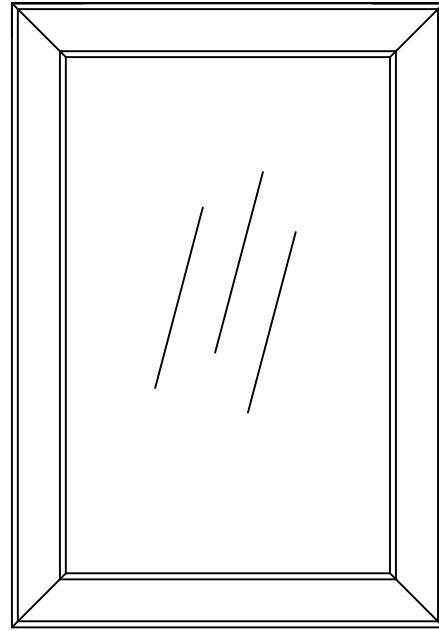

Minimum height and width = 6"

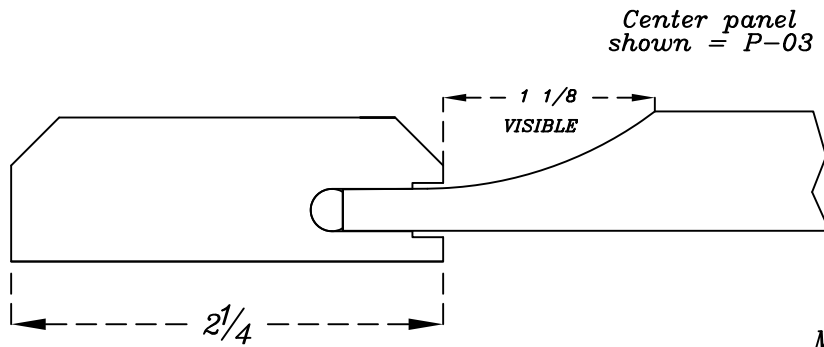

Mullion model

M011

5-PIECE DRAWER FRONT: # 9901/?

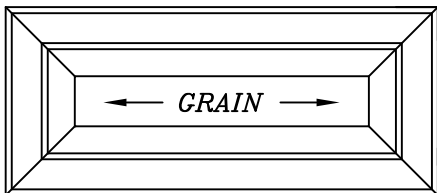

Minimum height and width available = 6 1/4"
(With a visible of 1 1/8")

Rails and stiles = 1 3/4"

Mitered drawer front matches framing bead and center panel profile

- 1 PROFILES
- 2 TRADITIONAL
- 3 DISTINCTIVE
- 4 CATHEDRAL
- 5 APPLIED MOLDINGS
- 6 PRESTIGE
- 7 WAINSCOTS
- 8 SPECIALTY PRODUCTS
- 9 MOULDINGS
- 10 PROMOTIONAL ITEMS
- 11 POLICY

Doors

Wainscots

WAH1/???

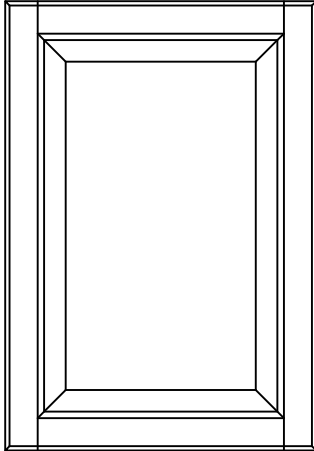

Available in these series:

Traditional
Distinctive
Applied mouldings
Prestige

WBH1/???

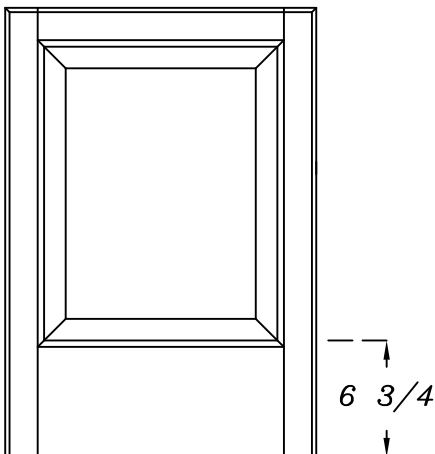

Available in these series:

Traditional
Distinctive
Applied mouldings

Squared bottom edge profiled=E-01

*******Note that unless specified,
bottom rail is always at 6 3/4"**

1	PROFILES
2	TRADITIONAL 90
3	DISTINCTIVE 90
4	CATHEDRAL 90
5	APPLIED MOULDINGS
6	PRESTIGE 45
7	WAINSCOTS
8	SPECIALTY PRODUCTS
9	MOULDINGS
10	PROMOTIONAL ITEMS
11	POLICY

Doors

Wainscots

WAH2/???

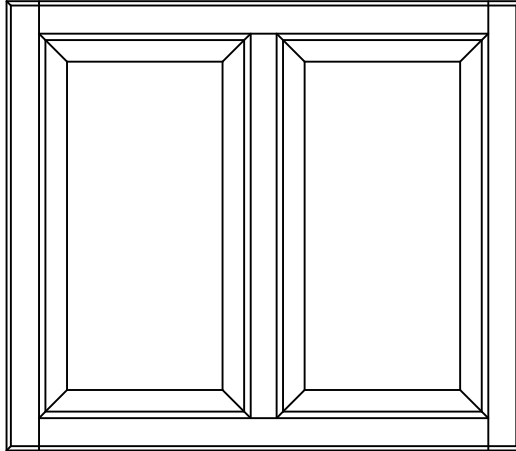

Available in these series:

- Traditional
- Distinctive
- Applied mouldings
- Prestige

WBH2/???

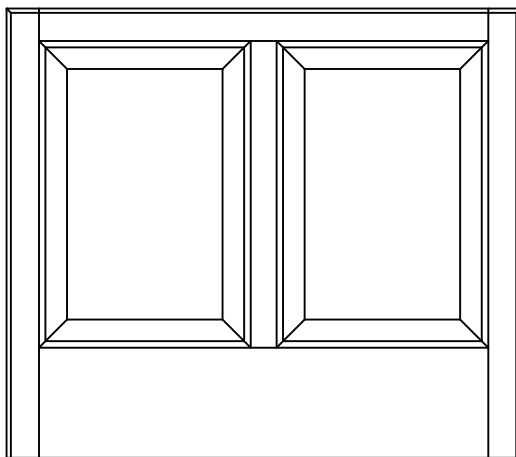

Available in these series:

- Traditional
- Distinctive
- Applied mouldings

Squared bottom edge profiled=E-01

******Note that unless specified, bottom rail is always at 6 3/4"*

Doors

Wainscots

1	PROFILES
2	TRADITIONAL 90
3	DISTINCTIVE 90
4	CATHEDRAL 90
5	APPLIED MOULDINGS
6	PRESTIGE 45
7	WAINSCOTS
8	SPECIALTY PRODUCTS
9	MOULDINGS
10	PROMOTIONAL ITEMS
11	POLICY

WAH3/???

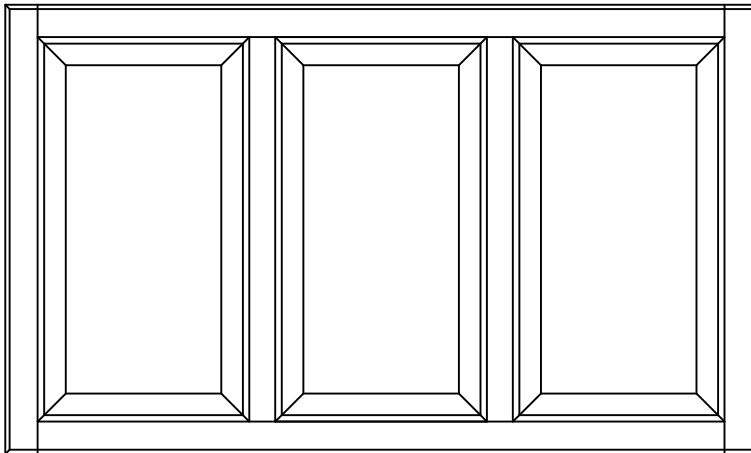

Available in these series:

- Traditional
- Distinctive
- Applied mouldings
- Prestige

WBH3/???

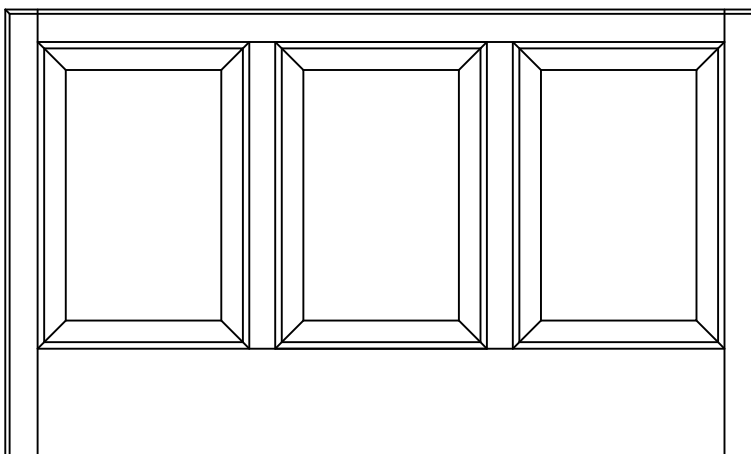

Available in these series:

- Traditional
- Distinctive
- Applied mouldings

Squared bottom edge profiled=E-01

******Note that unless specified,
bottom rail is always at 6 3/4"*

Doors

Wainscots

WAH4/???

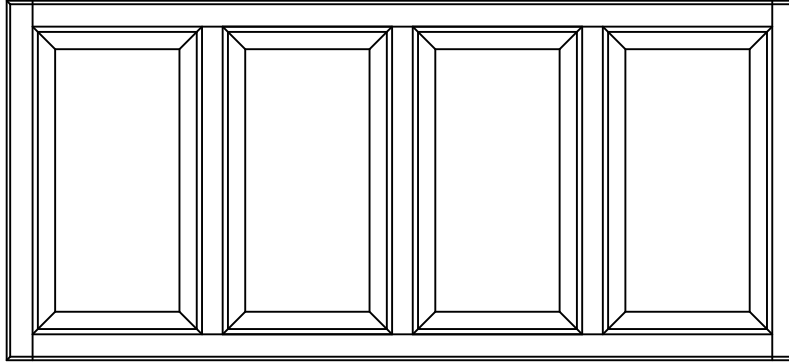

Available in these series:

- Traditional
- Distinctive
- Applied mouldings
- Prestige

WBH4/???

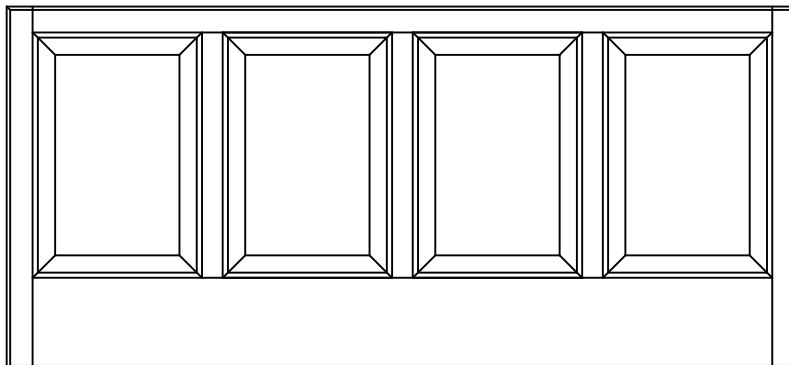

↓
6 3/4
↑

Squared bottom edge profiled=E-01

*****Note that unless specified,
bottom rail is always at 6 3/4"

Available in these series:

- Traditional
- Distinctive
- Applied mouldings

Doors

Wainscots

WAH5/???

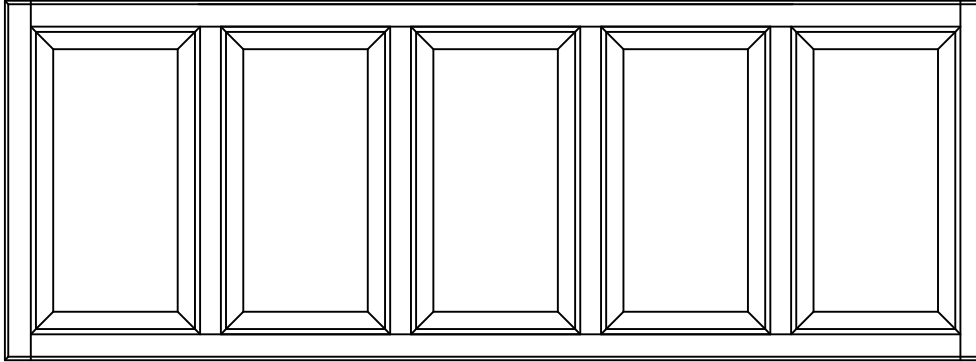

Available in these series:

Traditional
Distinctive
Applied mouldings
Prestige

WBH5/???

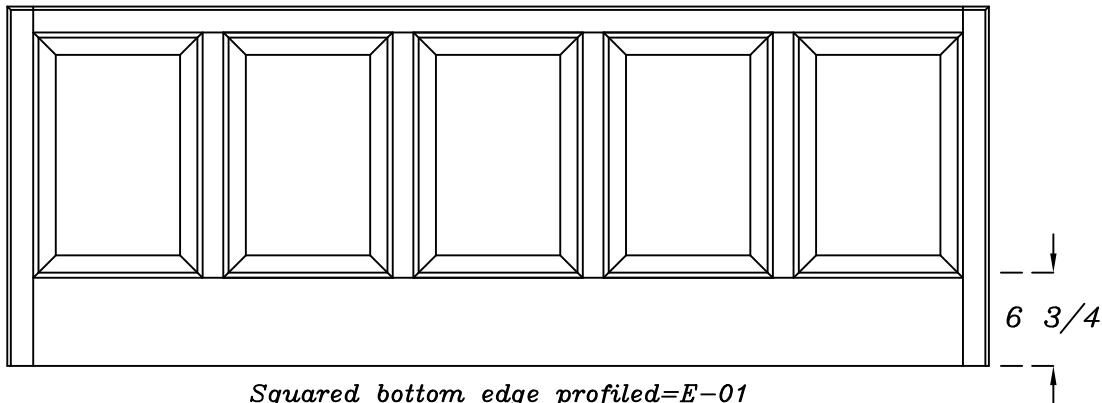

Squared bottom edge profiled=E-01

******Note that unless specified,
bottom rail is always at 6 3/4"*

Available in these series:

Traditional
Distinctive
Applied mouldings

1	PROFILES
2	TRADITIONAL 90
3	DISTINCTIVE 90
4	CATHEDRAL 90
5	APPLIED MOULDINGS
6	PRESTIGE 45
7	WAINSCOTS
8	SPECIALTY PRODUCTS
9	MOULDINGS
10	PROMOTIONAL ITEMS
11	POLICY

Doors

Wainscots

WAH6/???

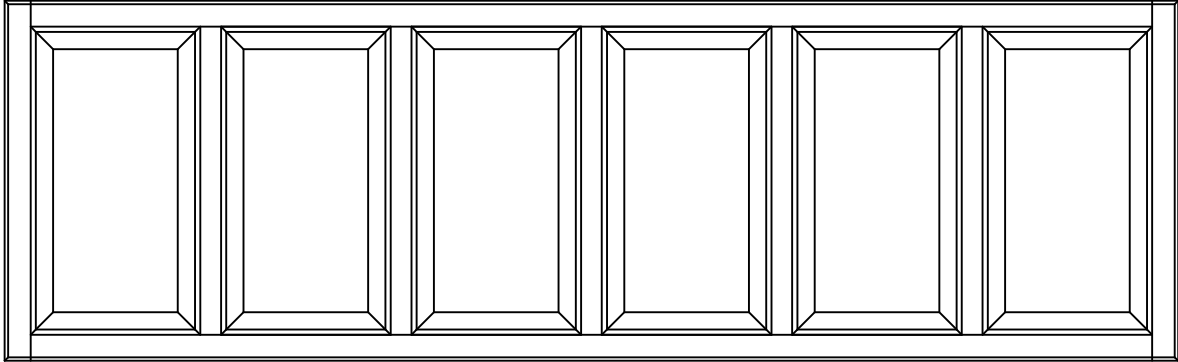

Available in these series:

- Traditional
- Distinctive
- Applied mouldings
- Prestige

WBH6/???

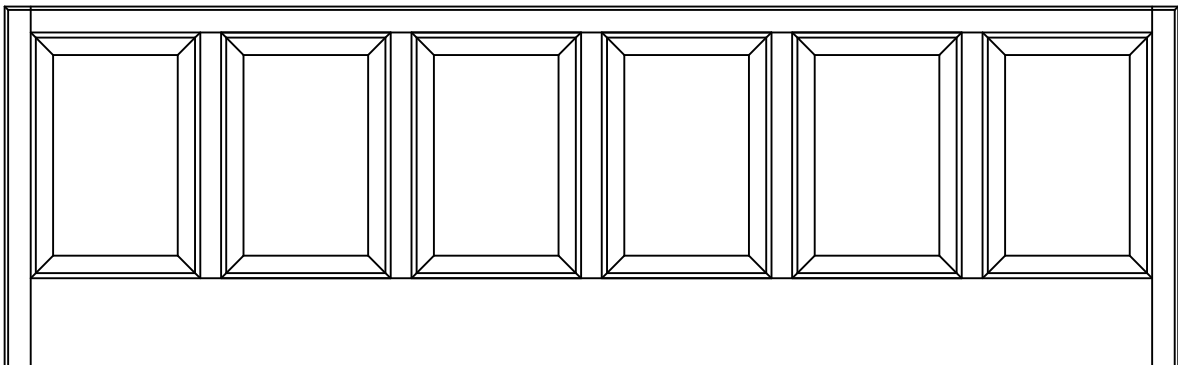

6 3/4

Squared bottom edge profiled=E-01

******Note that unless specified, bottom rail is always at 6 3/4"*

Available in these series:

- Traditional
- Distinctive
- Applied mouldings

Doors

Wainscots

WAV2/???

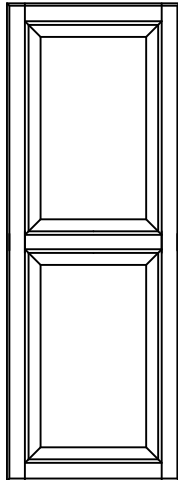

Available in these series:

Traditional
Distinctive
Applied mouldings
Prestige

WBV2/???

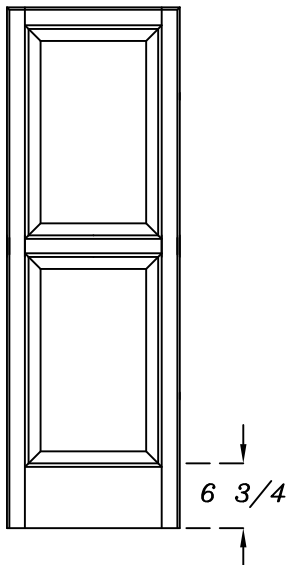

Available in these series:

Traditional
Distinctive
Applied mouldings

Squared bottom edge profiled=E-01

******Note that unless specified,
bottom rail is always at 6 3/4*

1	PROFILES
2	TRADITIONAL 90
3	DISTINCTIVE 90
4	CATHEDRAL 90
5	APPLIED MOULDINGS
6	PRESTIGE 45
7	WAINSCOTS
8	SPECIALTY PRODUCTS
9	MOULDINGS
10	PROMOTIONAL ITEMS
11	POLICY

Doors

Wainscots

WAT2/???

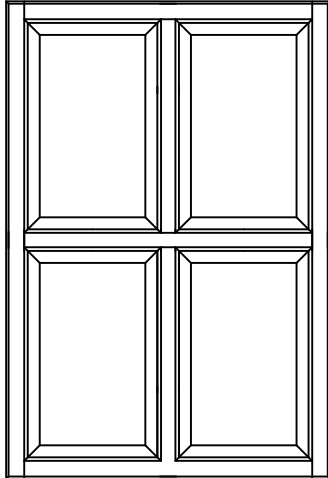

Available in these series:

Traditional
Distinctive
Applied mouldings

WBT2/???

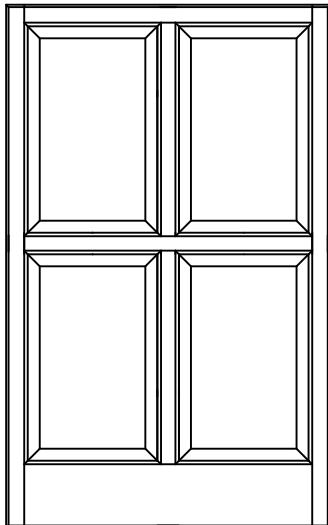

Available in these series:

Traditional
Distinctive
Applied mouldings

Squared bottom edge profiled=E-01

******Note that unless specified, bottom rail is always at 6 3/4"*

Doors

Wainscots

WAT3/???

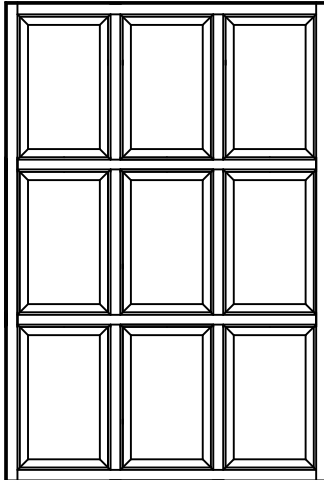

Available in these series:

Traditional
Distinctive
Applied mouldings

WBT3/???

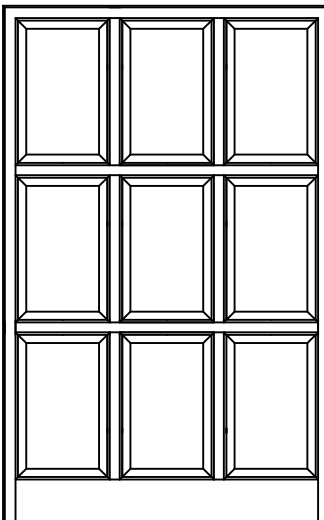

Squared bottom edge profiled=E-01

******Note that unless specified,
bottom rail is always at 6 3/4"*

Available in these series:

Traditional
Distinctive
Applied mouldings

1	PROFILES
2	TRADITIONAL 90
3	DISTINCTIVE 90
4	CATHEDRAL 90
5	APPLIED MOULDINGS
6	PRESTIGE 45
7	WAINSCOTS
8	SPECIALTY PRODUCTS
9	MOULDINGS
10	PROMOTIONAL ITEMS
11	POLICY

Doors

Wainscots

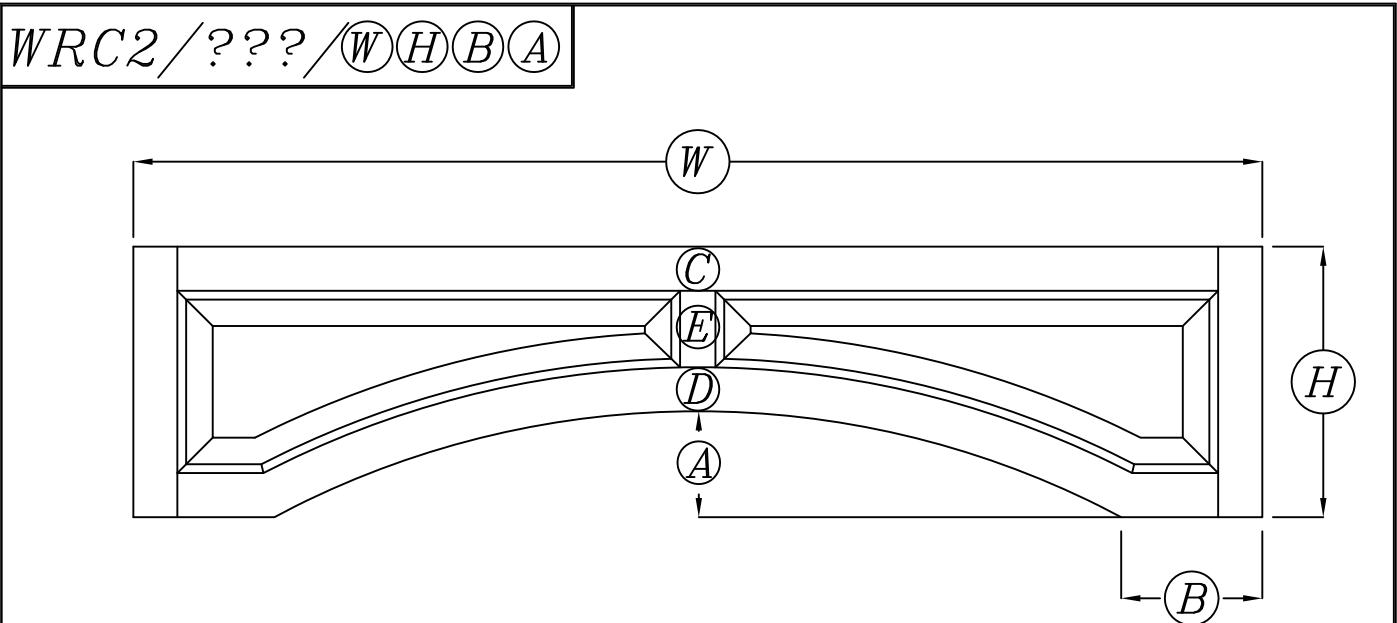

$$\textcircled{H} - \textcircled{A} - \textcircled{D} - \textcircled{C} = \textcircled{E} \text{ (2" minimum)}$$

$$\textcircled{E} = (\text{Visible center panel profile} \times 2) + 1/4$$

$$\textcircled{E} = \text{Must be higher than 2"}$$

Available in this serie:

Traditional

*Applied mouldings available for WRC2 are:
AM07, AM08, AM09, AM19 et AM22*

*Mitered door profiles are
not available*

Ⓜ	Width	MINIMUM=24"
ⓗ	Height	
Ⓟ	Flat width	
Ⓐ	Arch height	
Ⓒ	Rail width	
Ⓓ	Stile width	
Ⓔ	Center rail height	MINIMUM=2"

AMD1/???

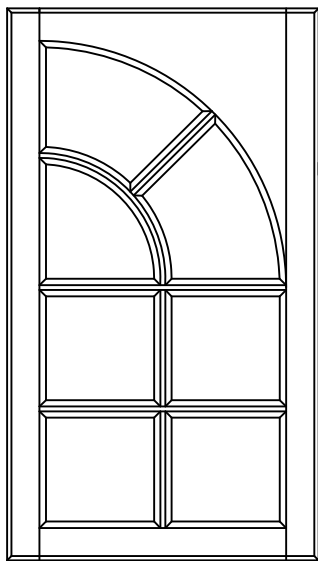

Right side shown

Available in this serie:
 Traditional
 With the Framing beads:
 A/B/C/E/J

AMD2/???

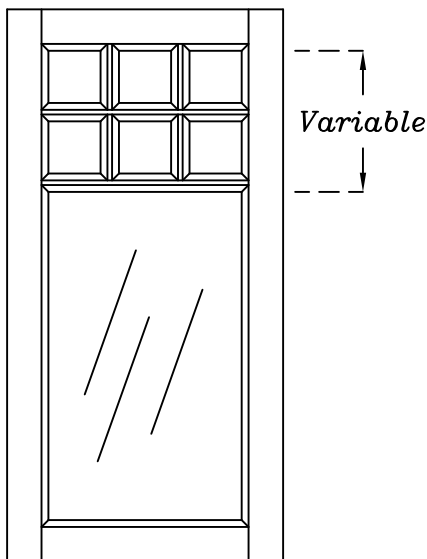

Available in these series:

Traditional
 Distinctive
 Applied mouldings
 Prestige

6 equal square tiles dimension, the dimension of tiles will fit the size of the frame.

MINIMUM WIDTH 11" based on stiles of 2 1/4"

In your order, if you wish to have a plan we will be pleased to provide one.

Speciality products

Frame door options

AMD3/???

Available in these series:

- Traditional
- Distinctive
- Applied mouldings
- Prestige

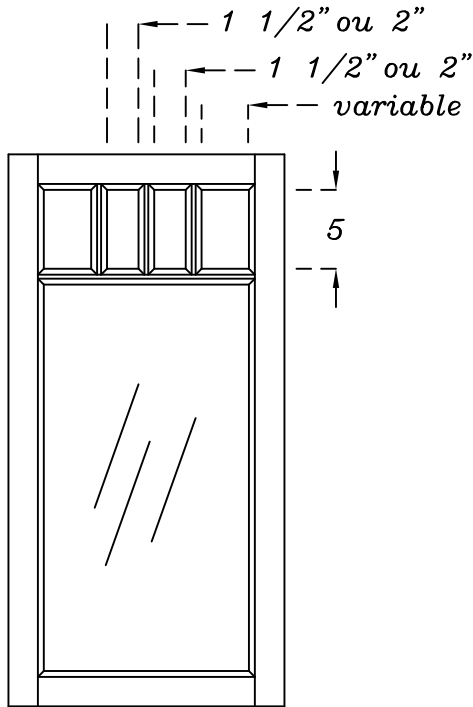

Both central tiles will always have 2" or 1 1/2" X 5", the dimension of tiles outside will fit the size of the frame.

MINIMUM WIDTH 13 1/2" based on stiles of 2 1/4"

In your order, if you wish to have a plan we will be pleased to provide one.

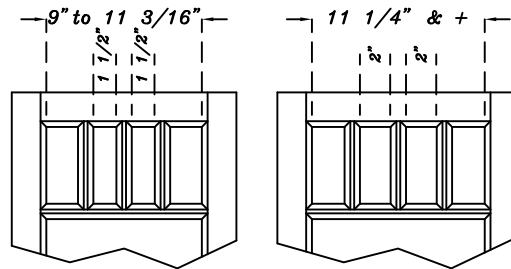

AMD5/???

Available in these series:

- Traditional
- Distinctive
- Applied mouldings
- Prestige

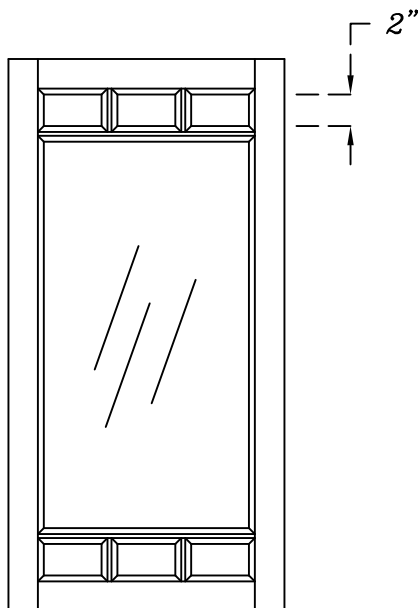

The tiles will always be 2" high, tile width will be divided into three equal sections.

MINIMUM WIDTH 11" based on stiles of 2 1/4"

MINIMUM HEIGHT 12 1/2" based on rails of 2 1/4"

In your order, if you wish to have a plan we will be pleased to provide one.

AMD6/???

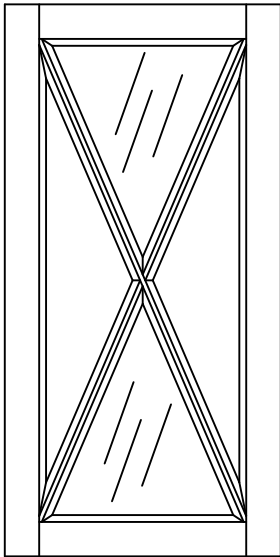

Available in these series:

Traditional
Applied mouldings
Prestige

MINIMUM WIDTH AND HEIGHT 10" based on rails and stiles of 2/4"

In your order, if you wish to have a plan we will be pleased to provide one.

AMD7/???

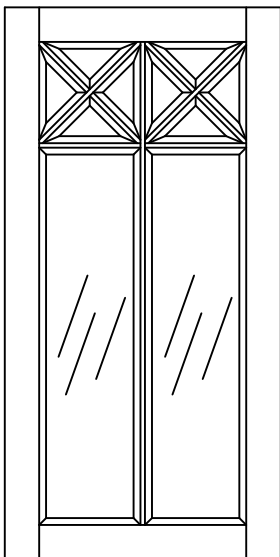

Available in these series:

Traditional
Applied mouldings
Prestige

Both top tiles will always be squared and will vary dimensions according to the width of the frame

MINIMUM WIDTH 12" based on stiles of 2/4"

MINIMUM HEIGHT has to be lower then the width

In your order, if you wish to have a plan we will be pleased to provide one.

Speciality products

Frame door options

AMD8/???

Available in these series:

Traditional
Distinctive
Applied mouldings
Prestige

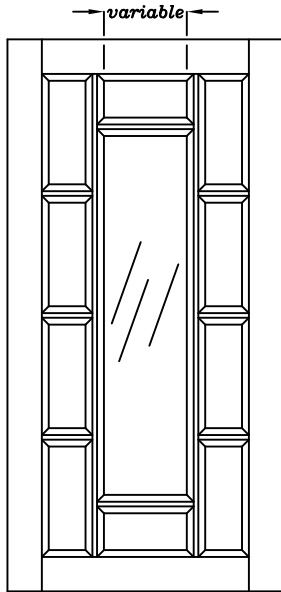

MINIMUM WIDTH 11 1/4" based on stiles of 2 1/4"
MINIMUM HEIGHT 15" based on rails of 2 1/4"

In your order, if you wish to have a plan we will be pleased to provide one.

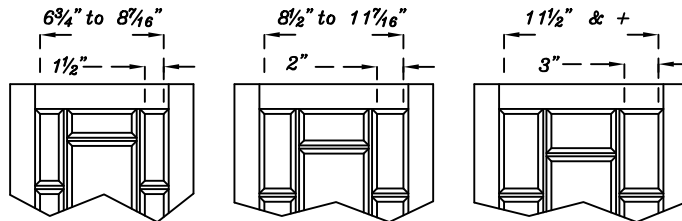

AMD9/???

Available in these series:

Traditional
Distinctive
Applied mouldings
Prestige

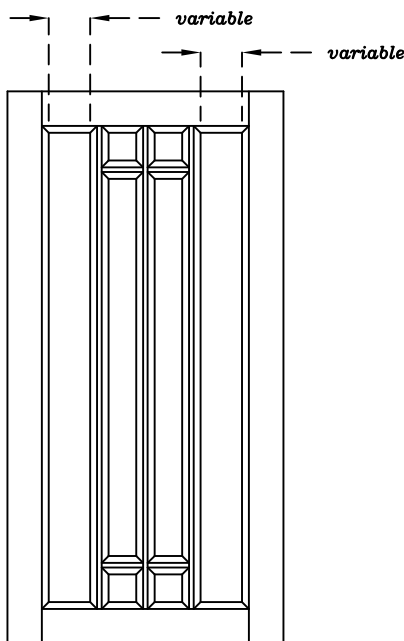

Top and bottom central tiles will always be squared and will vary dimensions according to the width of the frame

MINIMUM WIDTH 13 3/4" based on stiles of 2 1/4"
MINIMUM HEIGHT 12 1/2" based on rails of 2 1/4"

In your order, if you wish to have a plan we will be pleased to provide one.

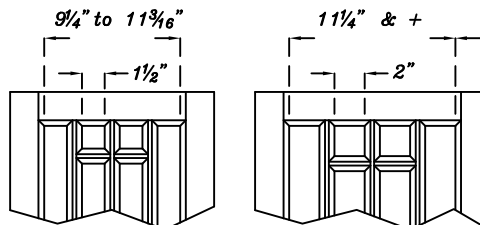

AMD10/???

Available in these series:

Traditional
Distinctive
Applied mouldings
Prestige

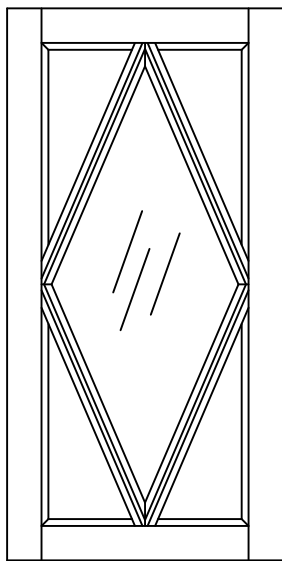

MINIMUM WIDTH and HEIGHT 10" based on stiles of 2/4"

In your order, if you wish to have a plan we will be pleased to provide one.

AMD11/???

Available in this serie:
Traditional
With the Framing beads:
A/B/C/E/J

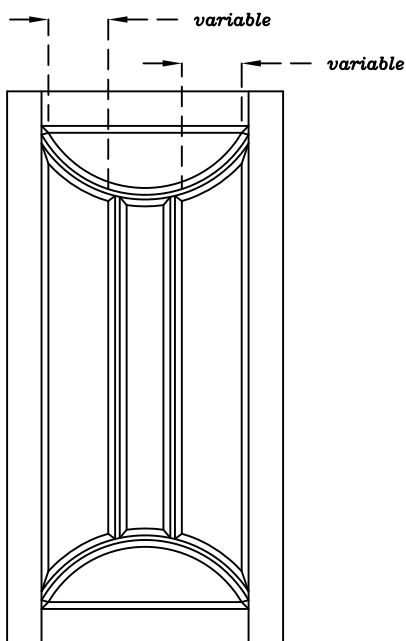

The central tile will have a width of 1 1/2", 2" or 3" according to the width of the frame.

In your order, if you wish to have a plan we will be pleased to provide one.

MINIMUM WIDTH 11 1/4" based on stiles of 2/4"

MINIMUM HEIGHT 14" based on rails of 2/4"

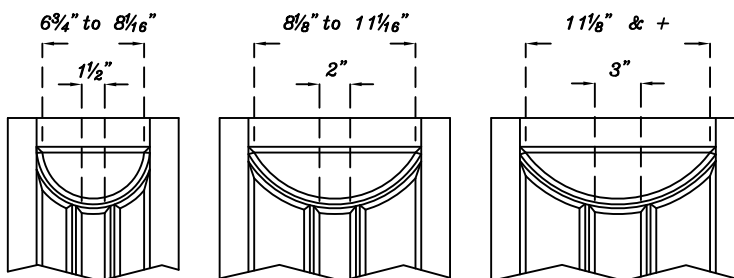

Speciality products

Frame door options

AMD12/???

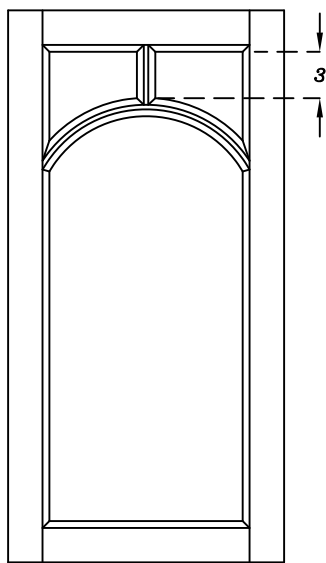

Available in this serie:
 Traditional
 With the Framing beads:
 A/B/C/E/J

*MINIMUM WIDTH 11 1/4" based on stiles of 2 1/4"
 MINIMUM HEIGHT 12" based on rails of 2 1/4"*

In your order, if you wish to have a plan we will be pleased to provide one.

AMD13/???

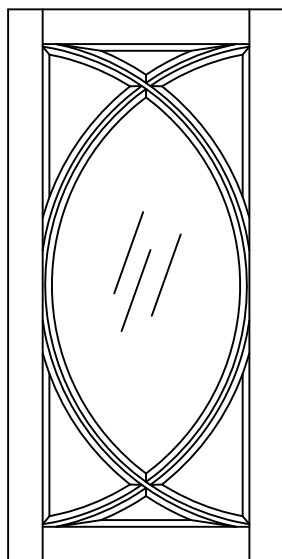

Available in this serie:
 Traditional
 With the Framing beads:
 A/B/C/E/J

*MINIMUM WIDTH 10" based on stiles of 2 1/4"
 THE MINIMUM HEIGHT IS TWO TIMES THE WIDTH
 (EX: 15" wide so the minimum height is 30")*

In your order, if you wish to have a plan we will be pleased to provide one.

AMD14/????

Available in this serie:
Traditional
With the Framing beads:
C/E/J

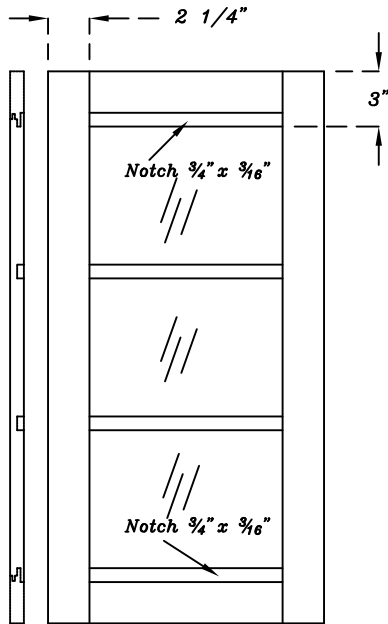

MINIMUM WIDTH 11 1/4" based on stiles of 2 1/4"
MINIMUM HEIGHT 11 1/2" based on rails of 2 1/4"

In your order, if you wish to have a plan we will be pleased to provide one.

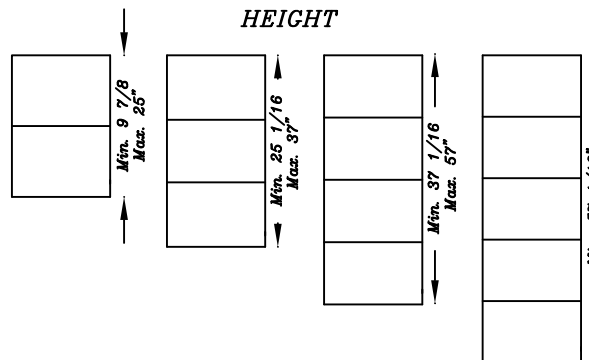

AMD15/????

Available in this serie:
Traditional
With the Framing beads:
A/B/C/E/J

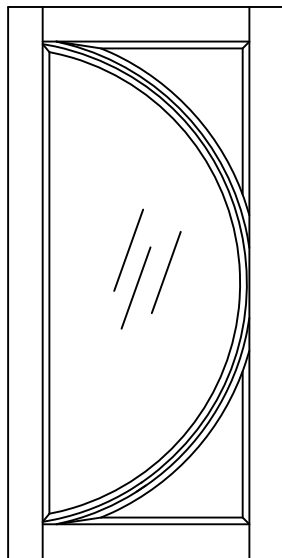

Right side shown

MINIMUM WIDTH 10" based on stiles of 2 1/4"
THE MINIMUM HEIGHT IS TWO TIMES THE WIDTH
(EX: 15" wide so the minimum height is 30")

In your order, if you wish to have a plan we will be pleased to provide one.

Speciality products

Frame door options

AMD16/???

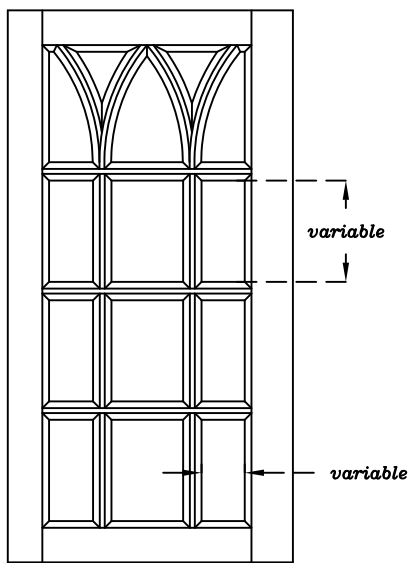

Available in this series:

Traditional

With the Framing beads:

A/B/C/E/J

The "V" will always be the same width and height, the vertical center tiles width will always be the same. Tile side will vary in width and height.

Note that, french model and AMD16 tiles won't align.

MINIMUM WIDTH 10" based on stiles of 2 1/4"

MINIMUM HEIGHT 14 1/2" based on rails of 2 1/4"

When you order we will send you a drawing for approval.

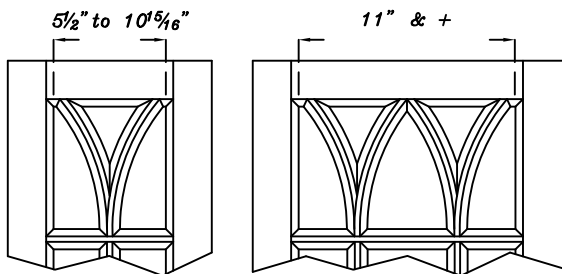

AMD17/???

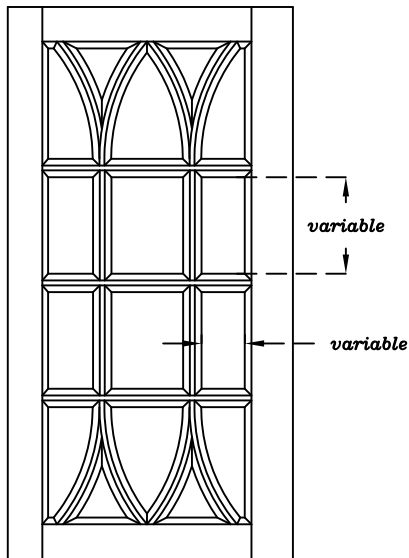

Available in this series:

Traditional

With the Framing beads:

A/B/C/E/J

The "V" will always be the same width and height, the vertical center tiles width will always be the same. Tile side will vary in width and height.

Note that, french model and AMD16 tiles won't align.

MINIMUM WIDTH 10" based on stiles of 2 1/4"

MINIMUM HEIGHT 23 1/2" based on rails of 2 1/4"

When you order we will send you a drawing for approval.

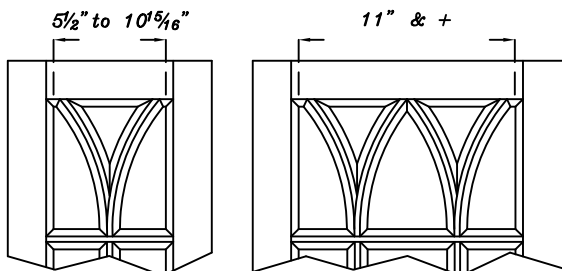

AMD18/???

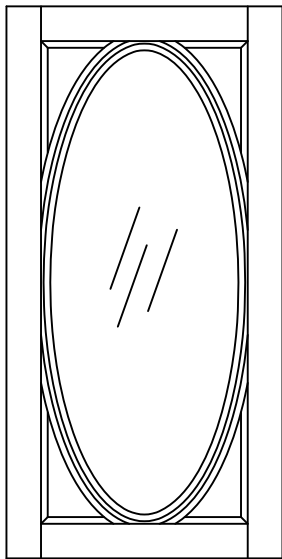

Available in this serie:
Traditional
With the Framing beads:
A/B/C/E/J

If your frame is square the inner moulding is going to be round.

*MINIMUM WIDTH 11" based on stiles of 2 1/4"
MINIMUM HEIGHT 14" based on rails of 2 1/4"*

When you order we will send you a drawing for approval.

AMD19/???

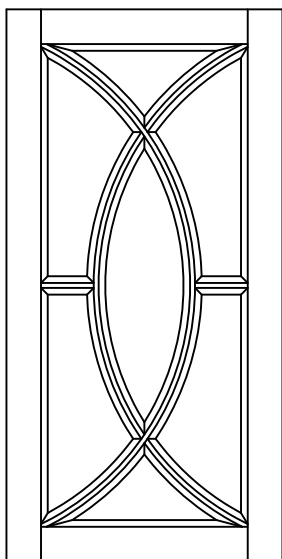

Available in this serie:
Traditional
With the Framing beads:
A/B/C/E/J

*MINIMUM WIDTH 10" based on stiles of 2 1/4"
MINIMUM HEIGHT 14" based on rails of 2 1/4"*

When you order we will send you a drawing for approval.

Speciality products

Frame door options

AMD20/???

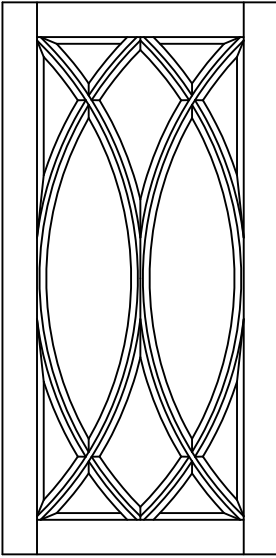

Available in this serie:
 Traditional
 With the Framing beads:
 A/B/C/E/J

MINIMUM WIDTH 12" based on stiles of 2/4"

MINIMUM HEIGHT 19" based on rails of 2/4"

When you order we will send you a drawing for approval.

Frame Options

Frame door options

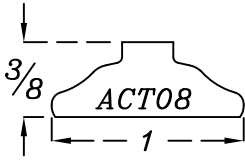
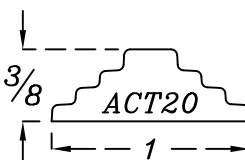
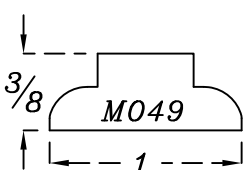
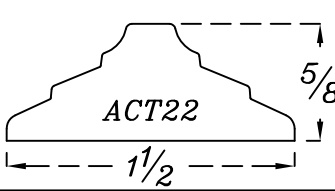
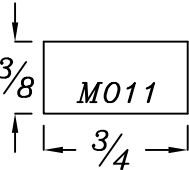
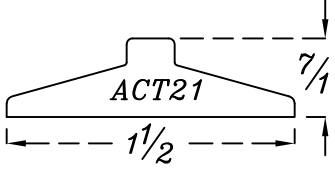
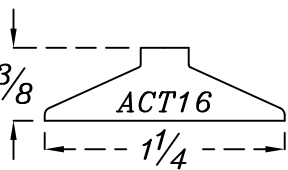
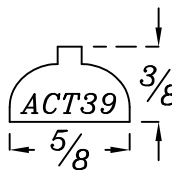
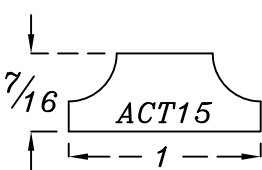
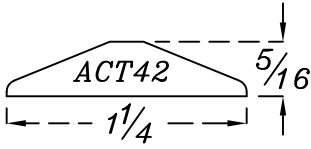
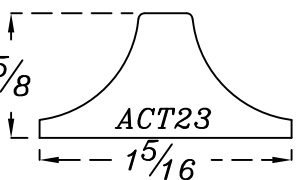
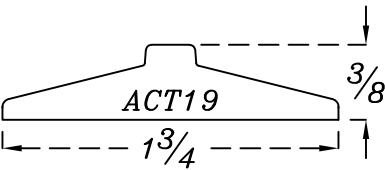
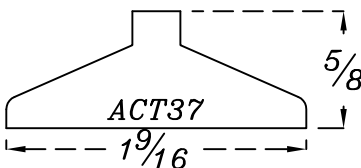
<i>Models of tiles</i>	<i>Framing beads</i>	<i>Models of tiles</i>	<i>Framing beads</i>
	A/F/G/M/P/W		V
	B		X
	C/D/E/H/J/N/O Q/S/Y/3/4/5		Z
	K		2
	L		7
	R		
	T		
	U		

- 1 PROFILES
- 2 TRADITIONAL 90
- 3 DISTINCTIVE 90
- 4 CATHEDRAL 90
- 5 APPLIED MOULDINGS
- 6 PRESTIGE 45
- 7 WAINSCOTS
- 8 SPECIALTY PRODUCTS
- 9 MOULDINGS
- 10 PROMOTIONAL ITEMS
- 11 POLICY

DOOR # X00/??#+ (PEGS)

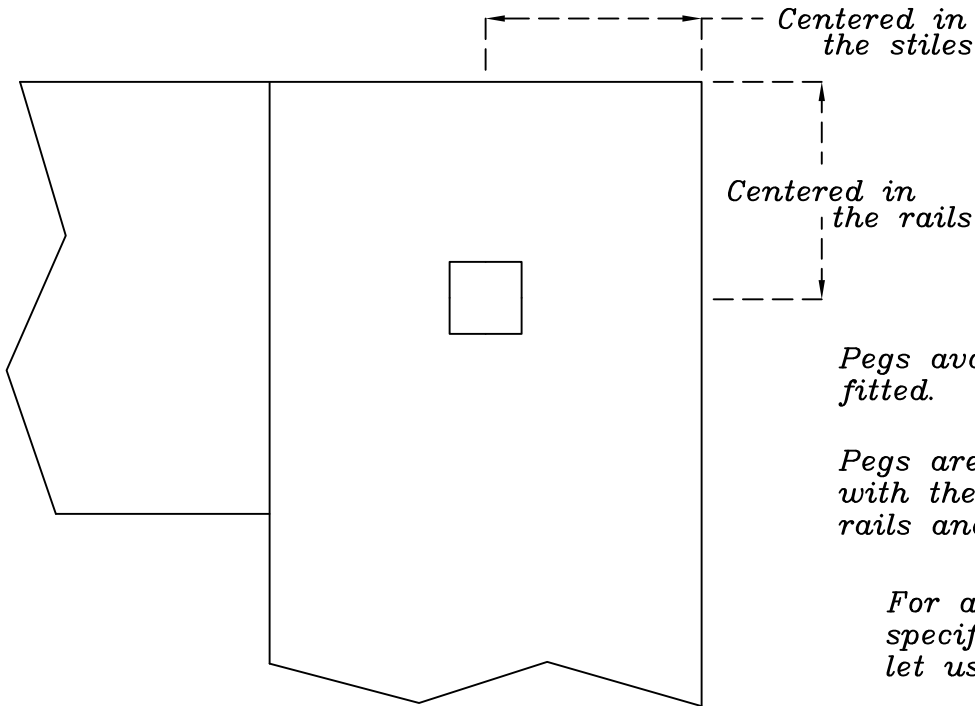

Pegs available 1/4" and 3/8" fitted.

Pegs are centered with the width of rails and stiles.

For any other specifications, let us know

Available in the distinctive and traditional series

SLAB: # 51/?

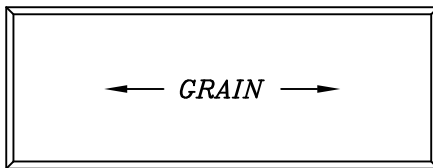

Match corresponding to door's edge profile

***No pegs on slabs

5-PIECE DRAWER FRONT: # X01/??#+ (PEGS)

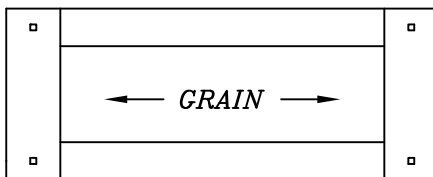

Match corresponding door's edge profile framing bead and center panel profile

+Pegs 1/4" or 3/8".

HINGE HOLES (type A)

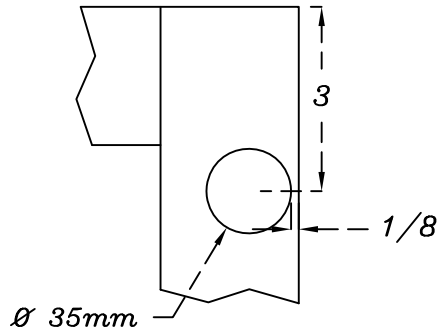

Height	Number of holes
9" to 39"	2
39 ¹ / ₁₆ " to 60"	3
60 ¹ / ₁₆ " to 80"	4
80 ¹ / ₁₆ " and more	5

- * 9" to 39" doors will have 2 hinge holes
- * 39 ¹/₁₆" to 60" doors will have 3 hinge holes with 1 centered
- * 60 ¹/₈" to 80" doors will have 4 hinge holes with 2 at 22" from each end
- * 80 ¹/₈" and more, doors will have 5 hinge holes with 2 at 22" from each end and 1 centered
- * For any other specifications, let us know

HINGE HOLES (type B)

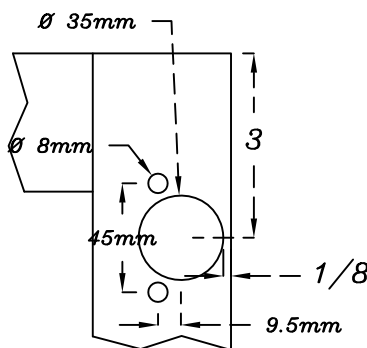

Height	Number of holes
9" to 39"	2
39 ¹ / ₁₆ " to 60"	3
60 ¹ / ₁₆ " to 80"	4
80 ¹ / ₁₆ " and more	5

- * 9" to 39" doors will have 2 hinge holes
- * 39 ¹/₁₆" to 60" doors will have 3 hinge holes with 1 centered
- * 60 ¹/₈" to 80" doors will have 4 hinge holes with 2 at 22" from each end
- * 80 ¹/₈" and more, doors will have 5 hinge holes with 2 at 22" from each end and 1 centered
- * For any other specifications, let us know

Speciality products

Appliance fronts

APF1/?

Center panel shown = P-02

Front

OPTIONS

?	Center panel profiles	Solid	P-01 to P-40	S-01 to S-17	P-23
		MDF	M-01 to M-75	M-51 to M-517	M-V5 to M-V7

APF2/???

Front

OPTIONS

?	Edge profiles	E-01 to E-58			
?	Framing beads	A/B/F/G/J/K/L/M/N/P/Q R/T/U/V/W/X/Z/2/3/5	C/D/O/Y/4/7	E/H/S	
?	Center panel profiles	Solid	P-01 to P-65	S-01 to S-17	P-23
		Veneer	V-01 to V-21	V-01 to V-21	V-05 to V-07
		MDF	M-01 to M-75 M-V1 to M-V3	M-51 to M-517 M-V1 to M-V3	M-V5 to M-V7

DISCONTINUED

222

Speciality products

Oven frame Appliance garage

OVF01 / ① ② ③ ④ ? / ...

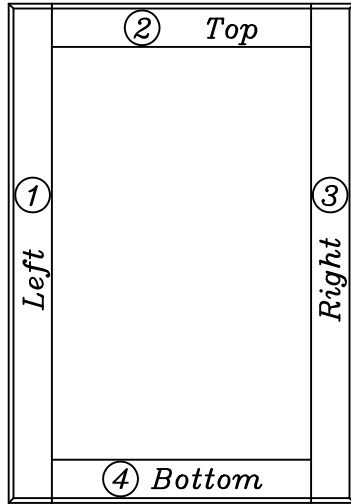

FRONT

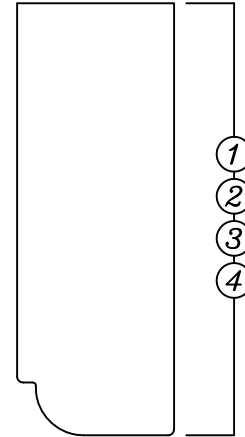

Edge profiles
shown = E-04

OPTIONS

①②③④	Width of rails	MINIMUM = 1"
?	Edge profiles	E-01 & E-41
...	Side(s) to be profiled	L=Left/R=Right/T=Top/B=Bottom

APG01 / ① ② ③ ? / ...

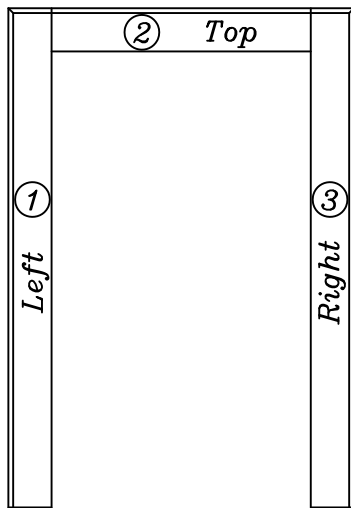

FRONT

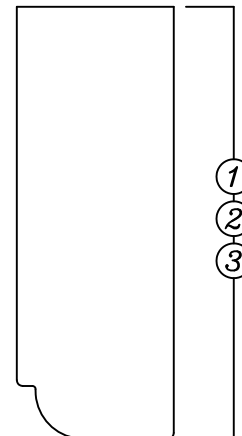

Edge profiles
shown = E-04

OPTIONS

①②③	Width of rails	MINIMUM = 1"
?	Edge profiles	E-01 & E-41
...	Side(s) to be profiled	L=Left/R=Right/T=Top/B=Bottom

- 1 PROFILES
- 2 TRADITIONAL 90
- 3 DISTINCTIVE 90
- 4 CATHEDRAL 90
- 5 APPLIED MOULDINGS
- 6 PRESTIGE 45
- 7 WAINSCOTS
- 8 SPECIALITY PRODUCTS
- 9 MOULDINGS
- 10 PROMOTIONAL ITEMS
- 11 POLICY

Speciality products

Oven frame

OVF02 / (A) (B) (1) (2) (3) (4) (5) (6) (7) ? / ...

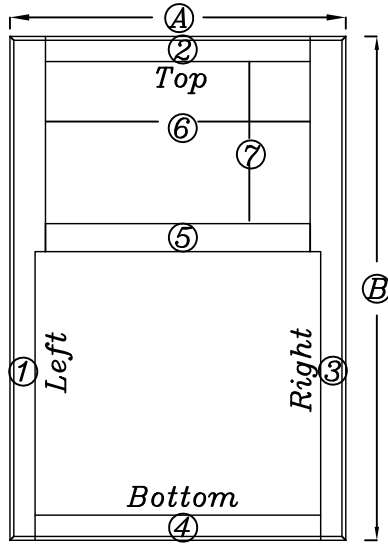

FRONT

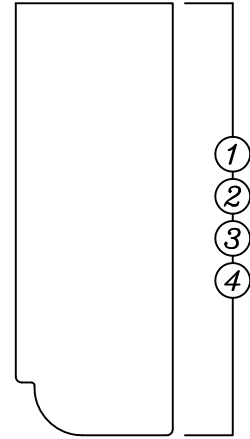

Edge profiles shown = E-04

OPTIONS

(A)	Width	
(B)	Height	
(1)(2)(3)(4)(5)	Width of rails	MINIMUM = 1"
(6)	Cutout Width	
(7)	Cutout Height	
?	Edge profiles	E-01 à E-41
...	Side(s) to be profiled	L=Left/R=Right/T=Top/B=Bottom

OVF03 / (A) (B) (1) (2) (3) (5) (6) (7) ? / ...

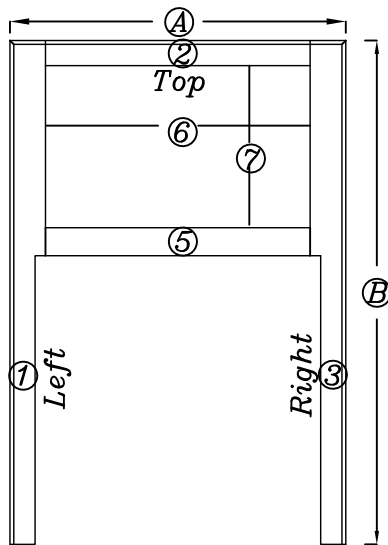

FRONT

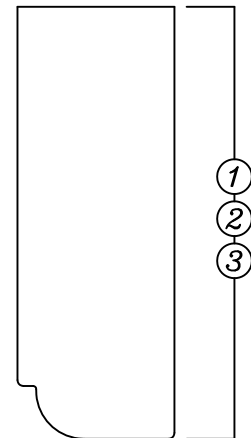

Edge profiles shown = E-04

OPTIONS

(A)	Width	
(B)	Height	
(1)(2)(3)(5)	Width of rails	MINIMUM = 1"
(6)	Cutout Width	
(7)	Cutout Height	
?	Edge profiles	E-01 à E-41
...	Side(s) to be profiled	L=Left/R=Right/T=Top/B=Bottom

Speciality products

Oven frame Appliance garage

OVF04 / (A) (B) ? / ...

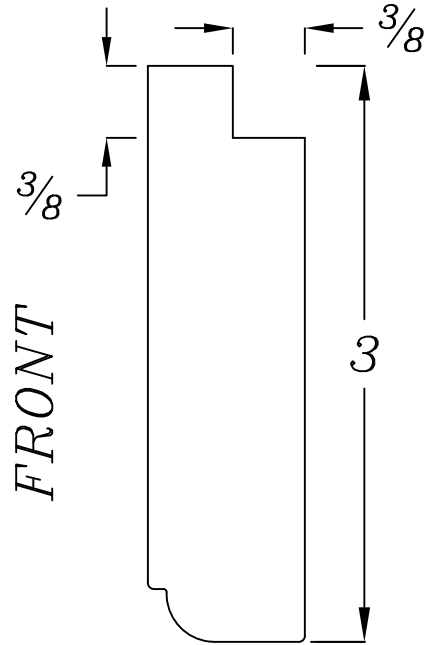
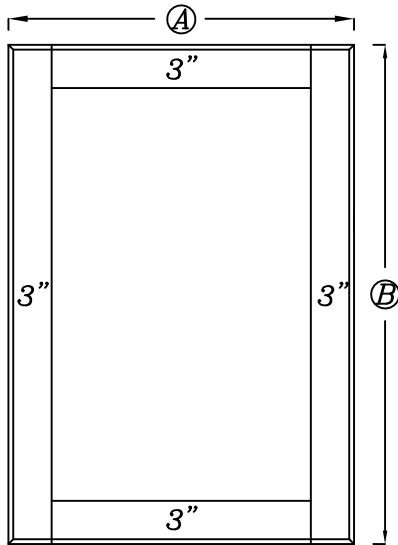

Edge profiles
shown = E-04

OPTIONS

(A)	Width	
(B)	Height	
?	Edge profiles	E-01 à E-40; except E-09
...	Side(s) to be profiled	L=Left/R=Right/T=dessus/B=Bottom

OVF05 / (A) (B) ? / ...

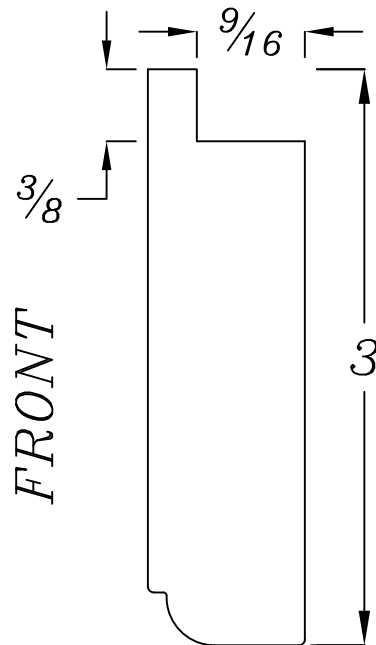
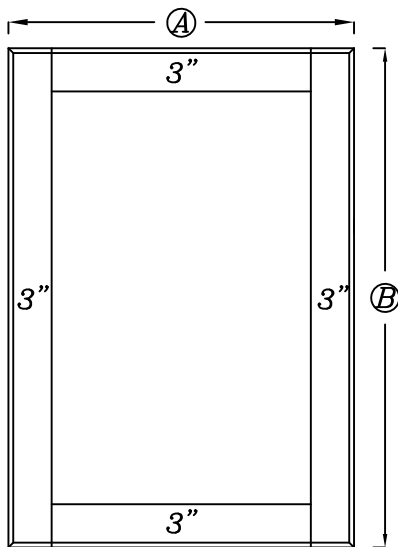

Edge profiles
shown = E-04

OPTIONS

(A)	Width	
(B)	Height	
?	Edge profiles	E-01 à E-40; except E-09
...	Side(s) to be profiled	L=Left/R=Right/T=dessus/B=Bottom

- 1 PROFILES
- 2 TRADITIONAL 90
- 3 DISTINCTIVE 90
- 4 CATHEDRAL 90
- 5 APPLIED MOULDINGS
- 6 PRESTIGE 45
- 7 WAINSCOTS
- 8 SPECIALITY PRODUCTS
- 9 MOULDINGS
- 10 PROMOTIONAL ITEMS
- 11 POLICY

FL01/ ① ② ,HCP ?/...

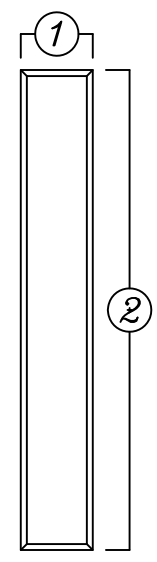
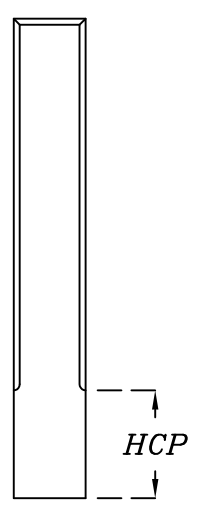

You can specify where you want the edge profile to stop using the HCP code.

OPTIONS

①	Width	MINIMUM=2 1/2"
②	Height	MINIMUM=24"
HCP	Toe kick height (edge profile)	
?	Edge profiles	E-01 to E-58
...	Side(s) to be profiled	L=left/R=right/T=top/B=bottom

Don't hesitate to send us any other specifications or new model of overlay fillers so we can make you a submission.

Speciality products

Overlay fillers

1 PROFILES
2 TRADITIONAL 90
3 DISTINCTIVE 90
4 CATHEDRAL 90
5 APPLIED MOULDINGS
6 PRESTIGE 45
7 WAINSCOTS
8 SPECIALITY PRODUCTS
9 MOULDINGS
10 PROMOTIONAL ITEMS
11 POLICY

FL02/ ① ② A,B,HCP,?/...

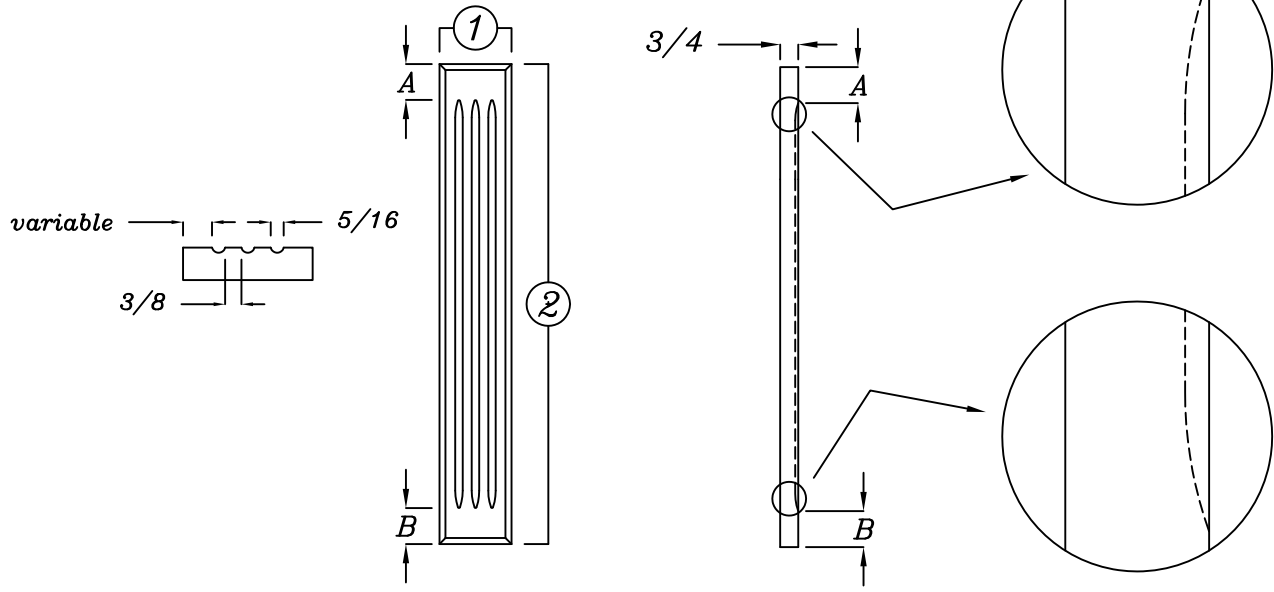

Flutes only available in 5/16" width

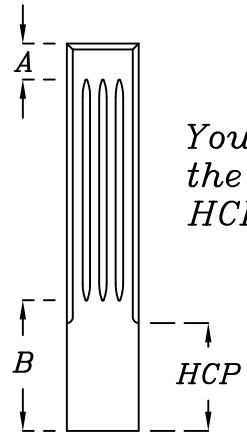

You can specify where you want the edge profile to stop using the HCP code.

OPTIONS

①	Width	MINIMUM=2 1/2"
②	Height	MINIMUM=24"
A	Measure between the top and end of flutes	
B	Measure between bottom and end of flutes	
HCP	Toe kick height (edge profile)	
?	Edge profiles	E-01 to E-58
...	Side(s) to be profiled	L=left/R=right/T=top/B=bottom

Width ①	Amount of flutes 5/16"
2 1/2" to 4 1/4"	3
4 5/16" to 4 15/16"	4
5" to 5 15/16"	5
6"	6

Speciality products

Overlay fillers

FL03/ ① ② ?/...

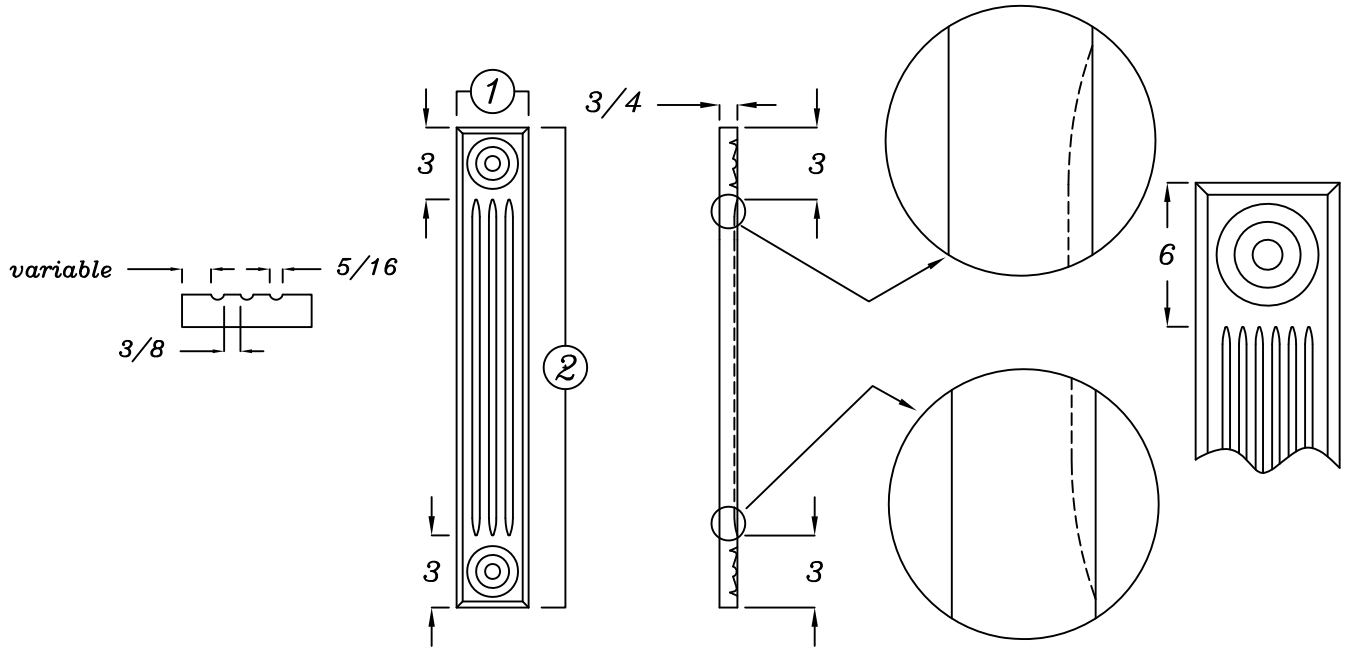

Flutes only available in 5/16" width

OPTIONS

①	Width	MINIMUM=2 1/2"
②	Height	MINIMUM=24"
?	Edge profiles	E-01 to E-58
...	Side(s) to be profiled	L=left/R=right/T=top/B=bottom

Width ①	Amount of flutes 5/16"	Rosettes diameter
2 1/2" to 4 1/4"	3	2 1/8"
4 5/16" to 4 15/16"	4	2 1/8"
5" to 5 15/16"	5	2 1/8"
6"	6	4

FL04/ ① ② ?/...

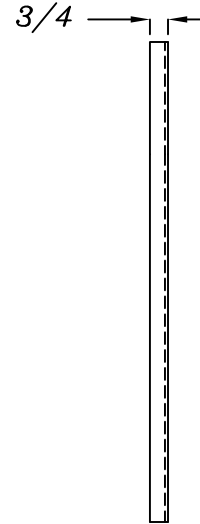
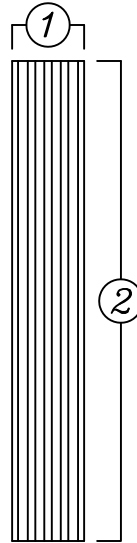
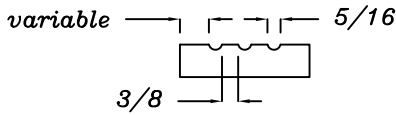

Flutes only available in 5/16" width

OPTIONS

①	Width	MINIMUM=2 1/2"
②	Height	MINIMUM=24"
?	Edge profiles	E-01 to E-58
...	Side(s) to be profiled	L=left/R=right/T=top/B=bottom

Width ①	Amount of flutes 5/16"	Rosettes diameter
2 1/2" to 4 1/4"	3	2 1/8"
4 5/16" to 4 15/16"	4	2 1/8"
5" to 5 15/16"	5	2 1/8"
6"	6	4

Speciality products

Overlay fillers

FL06/ ① ② B,HCP, ?/...

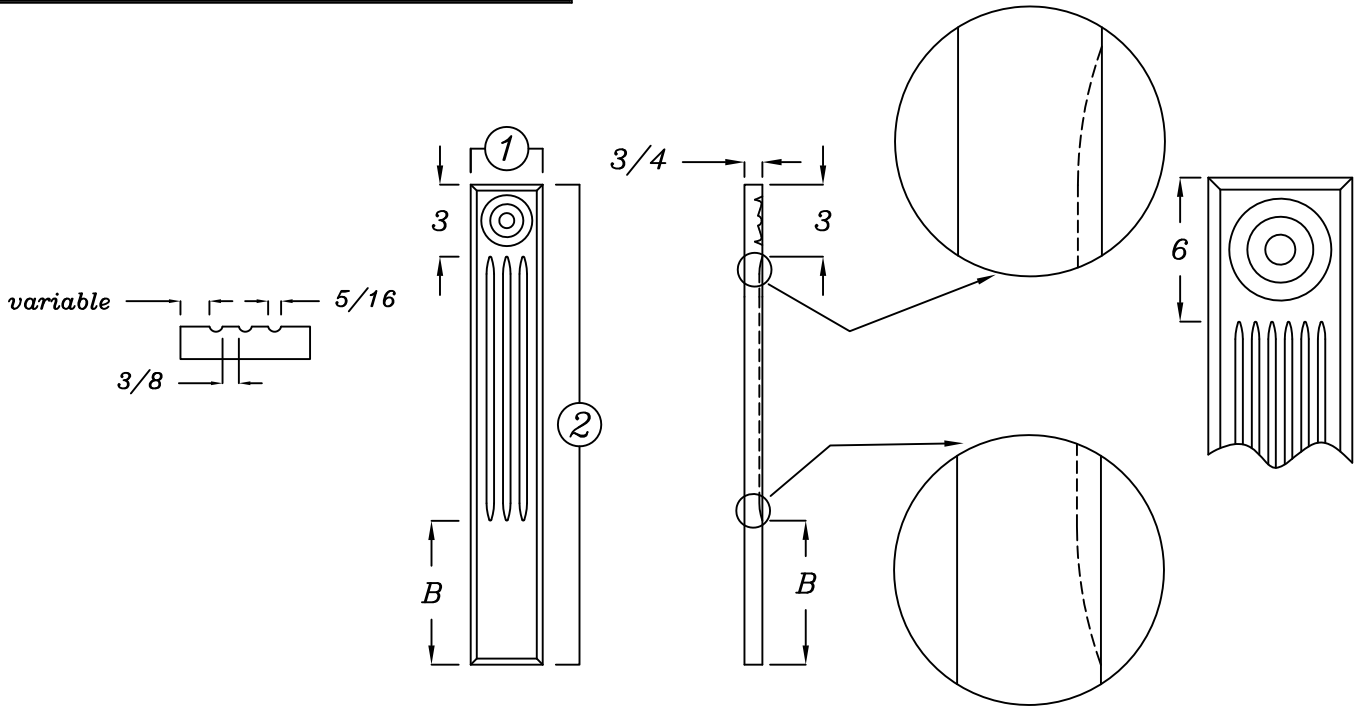

Flutes only available in 5/16" width

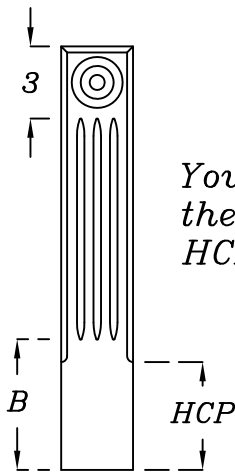

You can specify where you want the edge profile to stop using the HCP code.

OPTIONS

①	Width	MINIMUM=2 1/2"
②	Height	MINIMUM=24"
B	Measure between bottom and end of flutes	
HCP	Toe kick height (edge profile)	
?	Edge profiles	E-01 to E-58
...Side(s) to be profiled L=left/R=right/T=top/B=bottom		

Width ①	Amount of flutes 5/16"
2 1/2" to 4 1/4"	3
4 5/16" to 4 15/16"	4
5" to 5 15/16"	5
6"	6

FL08/ ① ② A,B,C,D,HCP, ??/...

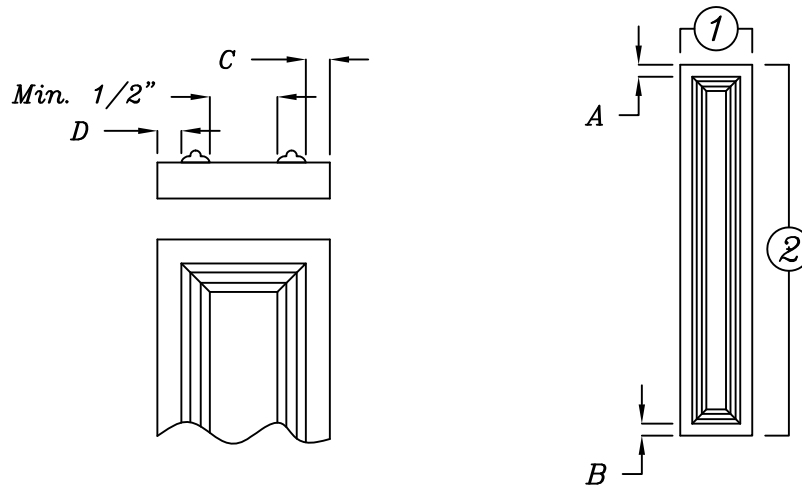

OPTIONS

①	Width	MINIMUM=2 1/2"
②	Height	MINIMUM=24"
A	Measure between the moulding and top of the filler	
B	Measure between the moulding and bottom of the filler	
C	Measure between the moulding and right of the filler	
D	Measure between the moulding and left of the filler	
HCP	Toe kick height (edge profile)	
?	Edge profiles	E-01 to E-58
?	# of applied moulding	Read below
...	Side(s) to be profiled	L=left/R=right/T=top/B=bottom

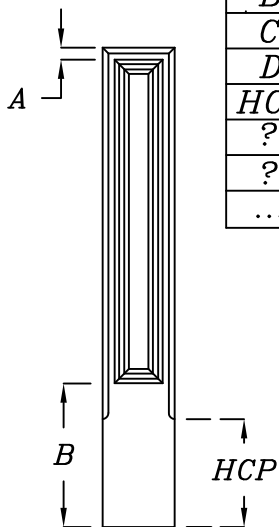

You can specify where you want the edge profile to stop using the HCP code.

Please refer to the section "Applied mouldings" for your choice of moulding.

Speciality products

Overlay fillers

FL09/ ①② A,B,E,F,HCP,?/...

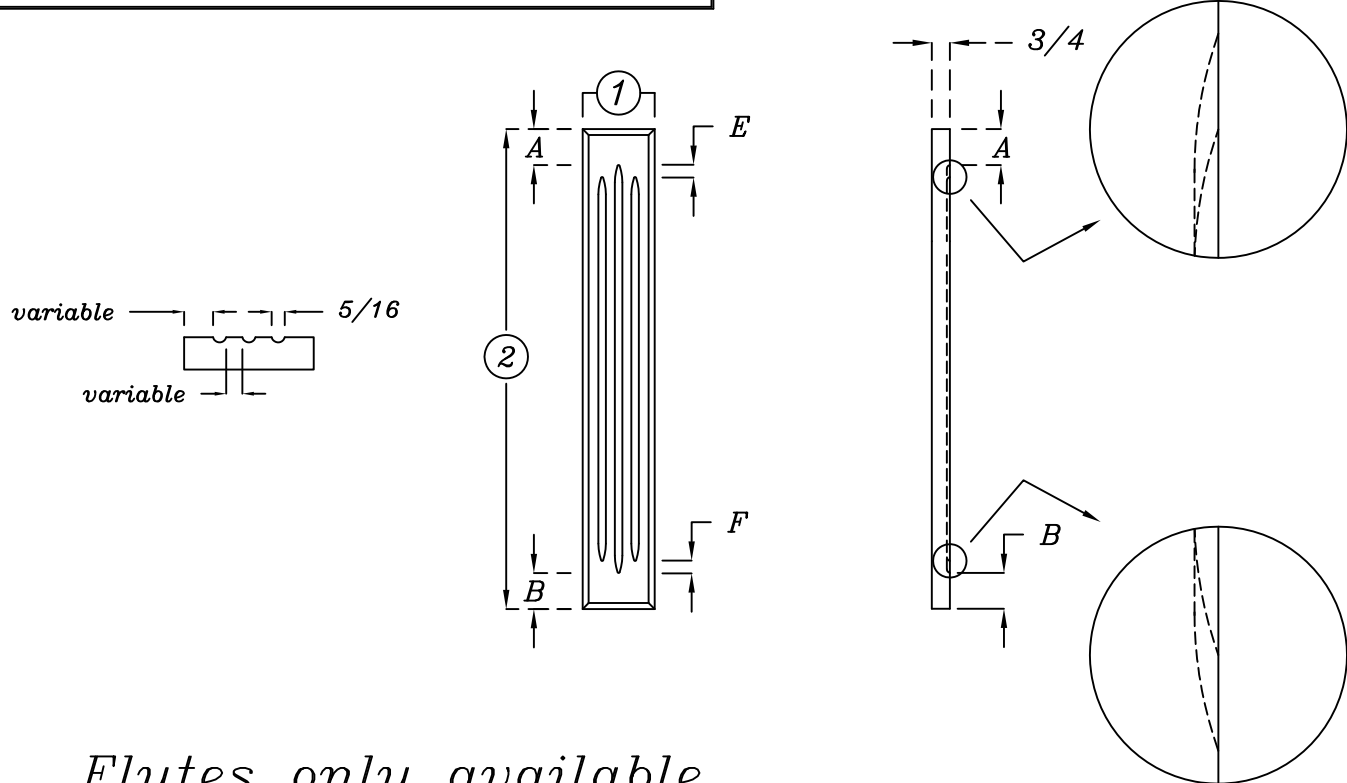

Flutes only available in 5/16" width

Width ①	Amount of flutes 5/16"
2 1/2" to 6"	3 divided in equal parts

OPTIONS

①	Width	MINIMUM=2 1/2"
②	Height	MINIMUM=24"
A	Measure between top and central flutes of the filler	
B	Measure between bottom and central flutes of the filler	
E	Measure between two top flutes (1/2" standard)	
F	Measure between two bottom flutes (1/2" standard)	
HCP	Toe kick height (edge profile)	
?	Edge profiles	E-01 to E-58
...	Side(s) to be profiled	L=left/R=right/T=top/B=bottom

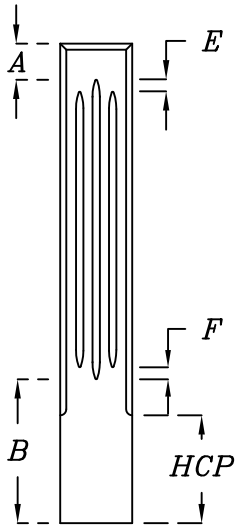

You can specify where you want the edge profile to stop using the HCP code.

FL11/ ①② A,B,E,F,HCP,?/...

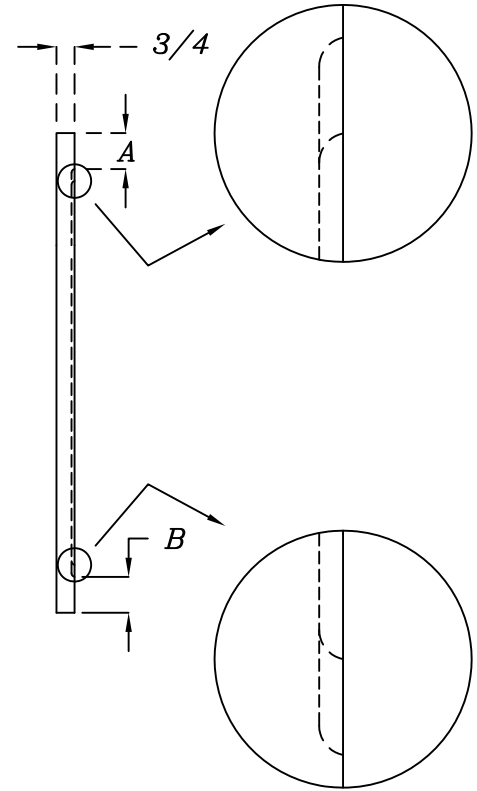
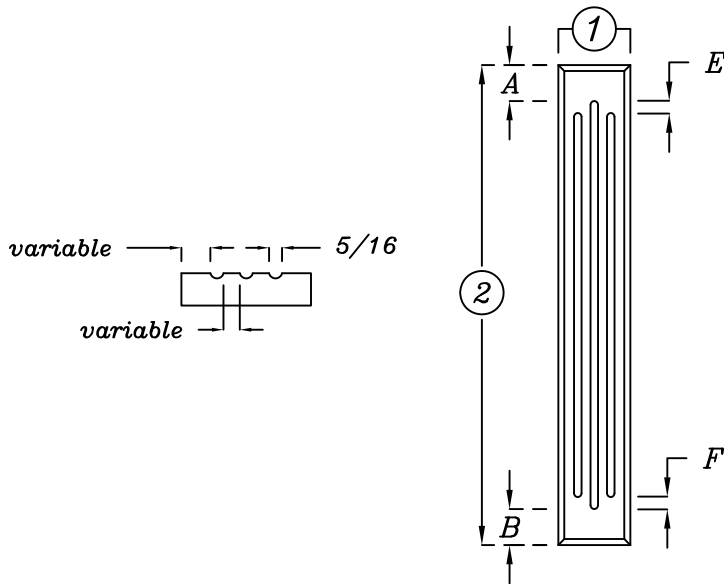

Flutes only available in 5/16" width

Width ①	Amount of flutes 5/16"
2 1/2" to 6"	3 divided in equal parts

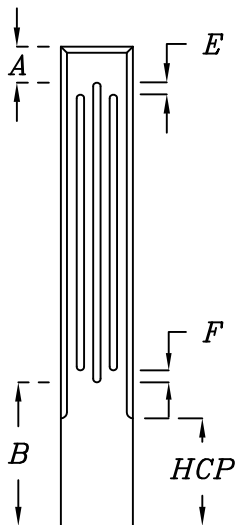

OPTIONS

①	Width	MINIMUM=2 1/2"
②	Height	MINIMUM=24"
A	Measure between top and central flutes of the filler	
B	Measure between bottom and central flutes of the filler	
E	Measure between two top flutes (1/2" standard)	
F	Measure between two bottom flutes (1/2" standard)	
HCP	Toe kick height (edge profile)	
?	Edge profile	E-01 to E-58
...	Side(s) to be profiled	L=left/R=right/T=top/B=bottom

You can specify where you want the edge profile to stop using the HCP code.

Speciality products

Overlay fillers

FL12/ ① ② A,B,HCP,?/...

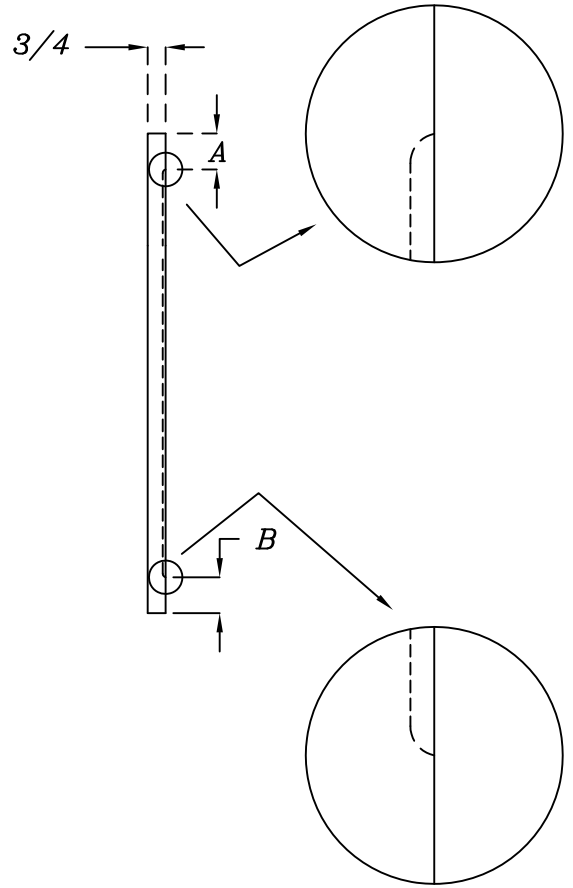
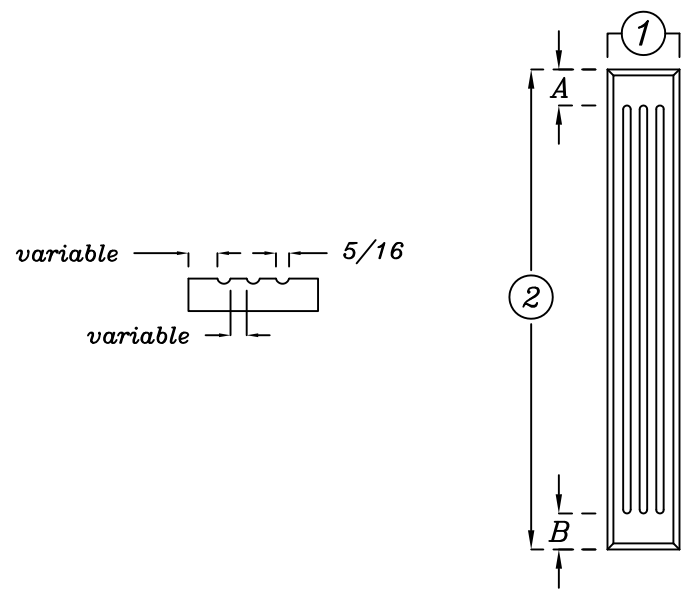

Flutes only available in 5/16" width

Width ①	Amount of flutes 5/16"
2 1/2" to 6"	3 divided in equal parts

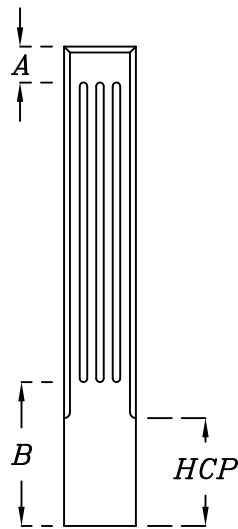

OPTIONS

①	Width	MINIMUM=2 1/2"
②	Height	MINIMUM=24"
A	Measure between top of the filler and end of flutes	
B	Measure between bottom of the filler and end of flutes	
HCP	Toe kick height (edge profile)	
?	Edge profiles	E-01 to E-58
...	Side(s) to be profiled	L=left/R=right/T=top/B=bottom

You can specify where you want the edge profile to stop using the HCP code.

FL13/ ① ② A,B,C,D,HCP, ?/...

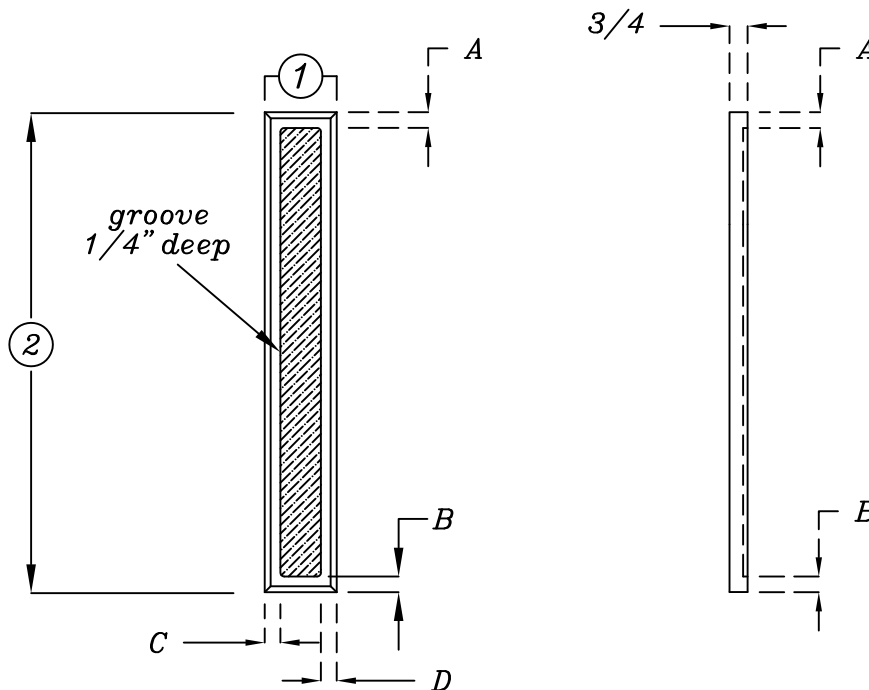

Width ①
3" to 6"

OPTIONS

①	Width	MINIMUM=3"
②	Height	MINIMUM=24"
A	Measure between cutout and top of the filler	
B	Measure between cutout and bottom of the filler	
C	Measure between cutout and left side of the filler	
D	Measure between cutout and right side of the filler	
HCP	kick height (edge profile)	
?	Edge profiles	E-01 to E-58
...	Side(s) to be profiled	L=left/R=right/T=top/B=bottom

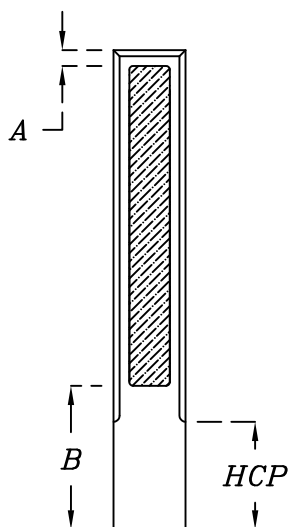

You can specify where you want the edge profile to stop using the HCP code.

Speciality products

Overlay fillers

FL14/ ① ② A,B,HCP,?/...

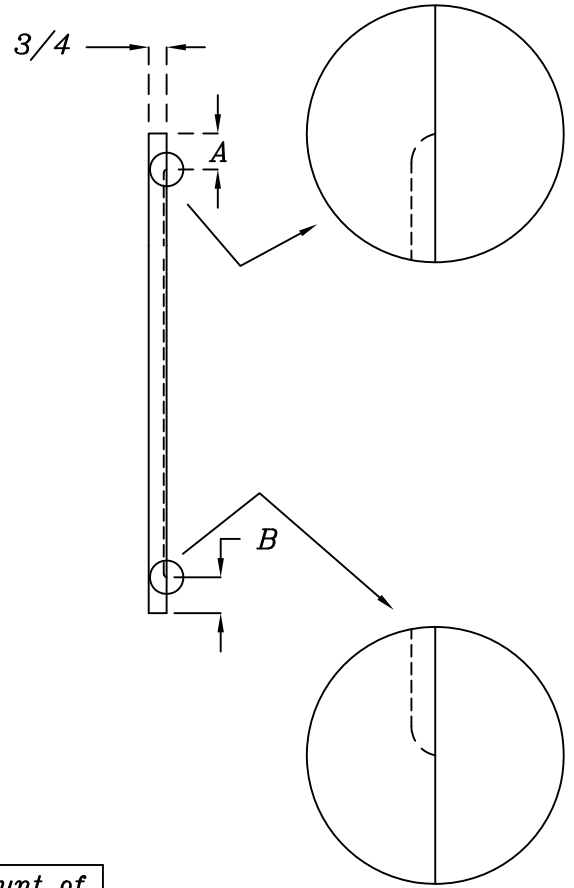
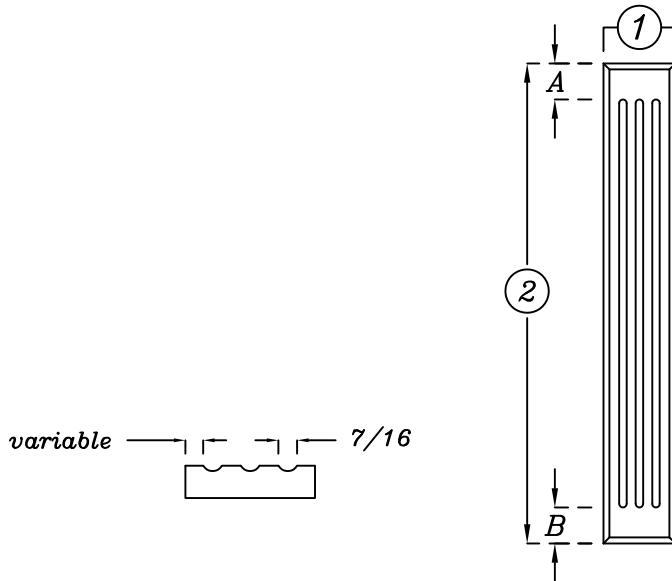

Flutes only available in 7/16" width

Width ①	Amount of flutes 7/16"
1 7/8" to 2 13/16"	2
2 7/8" to 3 13/16"	3
3 7/8" to 4 13/16"	4
4 7/8" to 5 13/16"	5
5 7/8" to 6 13/16"	6

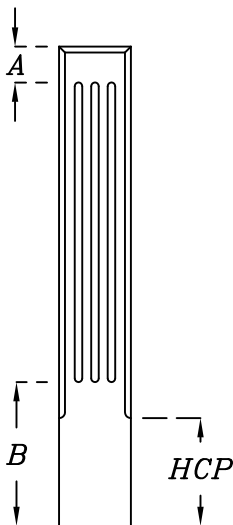

OPTIONS

①	Width	MINIMUM=1 7/8"
②	Height	MINIMUM=24"
A	Measure between top of the filler and end of flutes	
B	Measure between bottom of the filler and end of flutes	
HCP	Toe kick height (edge profile)	
?	Edge profiles	E-01 to E-58
...	Side(s) to be profiled	L=left/R=right/T=top/B=bottom

You can specify where you want the edge profile to stop using the HCP code.

FL16/ ①② A,B,E,F,HCP, ?/...

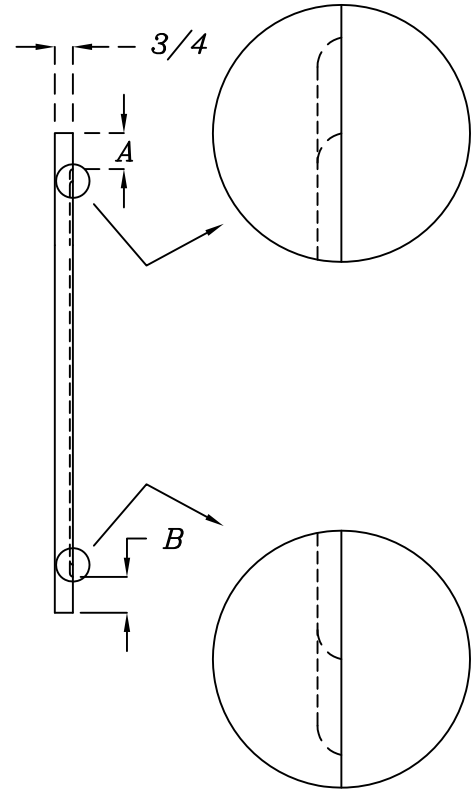
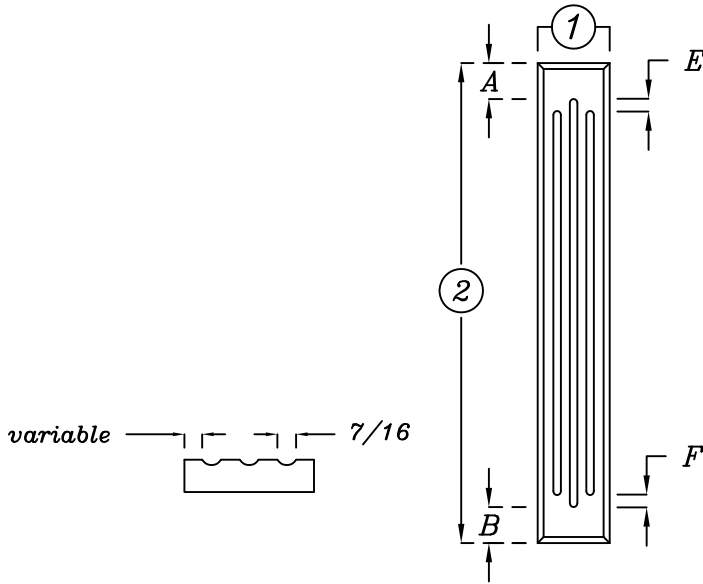

Flutes only available in 7/16" width

Width ①	Amount of flutes 7/16"
2 7/8" to 6"	3 divided in equal parts

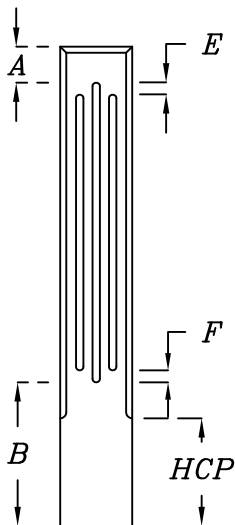

OPTIONS

①	Width	MINIMUM=2 1/2"
②	Height	MINIMUM=24"
A	Measure between top and central flutes of the filler	
B	Measure between bottom and central flutes of the filler	
E	Measure between two top flutes (1/2" standard)	
F	Measure between two bottom flutes (1/2" standard)	
HCP	Toe kick height (edge profile)	
?	Edge profiles	E-01 to E-58
...	Side(s) to be profiled	L=left/R=right/T=top/B=bottom

You can specify where you want the edge profile to stop using the HCP code.

Speciality products

Overlay fillers

FL17/ ①② A,B,E,F,HCP,?/...

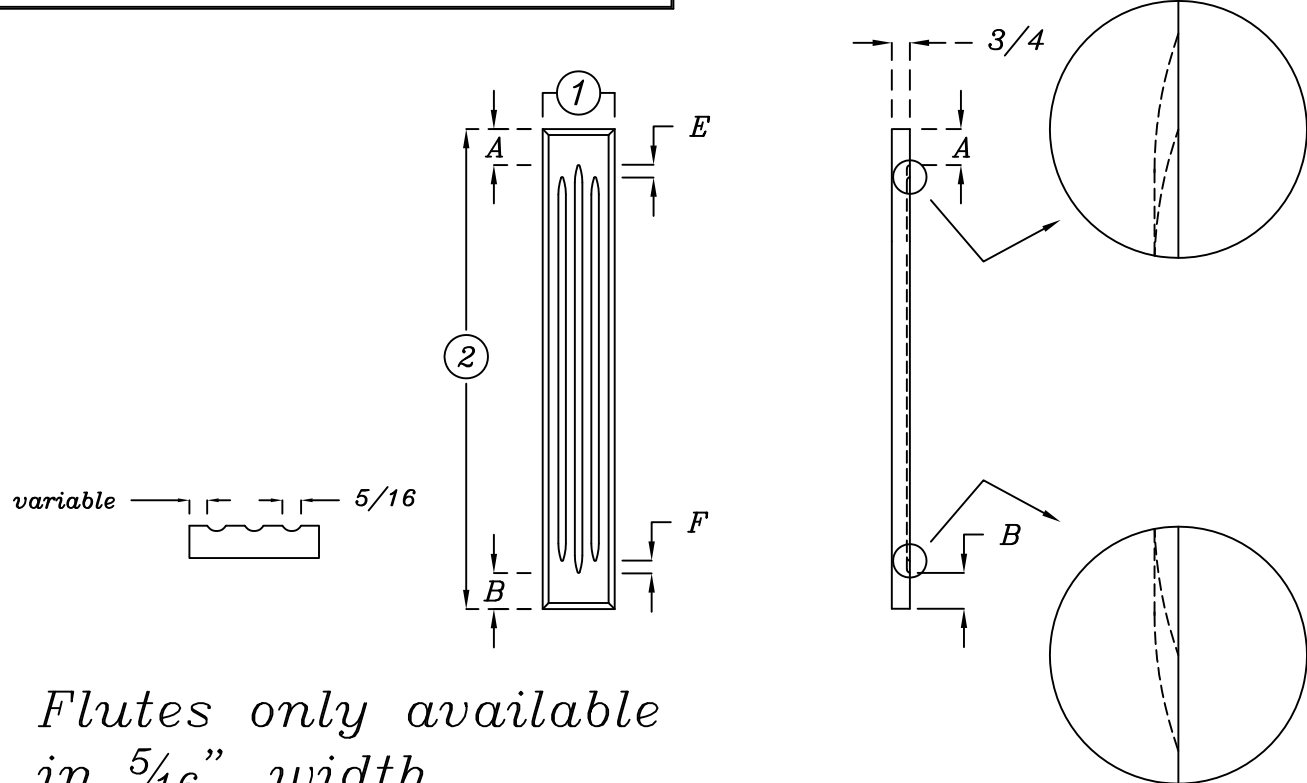

Flutes only available in 5/16" width

Width ①	Amount of flutes 5/16"
2 7/8" to 6"	3 divided in equal parts

OPTIONS

①	Width	MINIMUM=2 1/2"
②	Height	MINIMUM=24"
A	Measure between top and central flutes of the filler	
B	Measure between bottom and central flutes of the filler	
E	Measure between two top flutes (1/2" standard)	
F	Measure between two bottom flutes (1/2" standard)	
HCP	Toe kick height (edge profile)	
?	Edge profiles	E-01 to E-58
...	Side(s) to be profiled	L=left/R=right/T=top/B=bottom

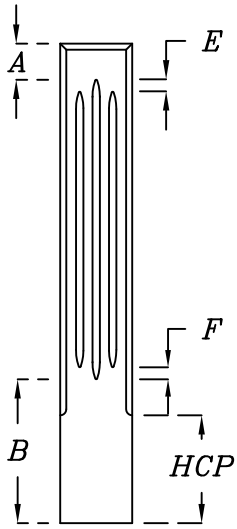

You can specify where you want the edge profile to stop using the HCP code.

FL18/ ① ② ?/...

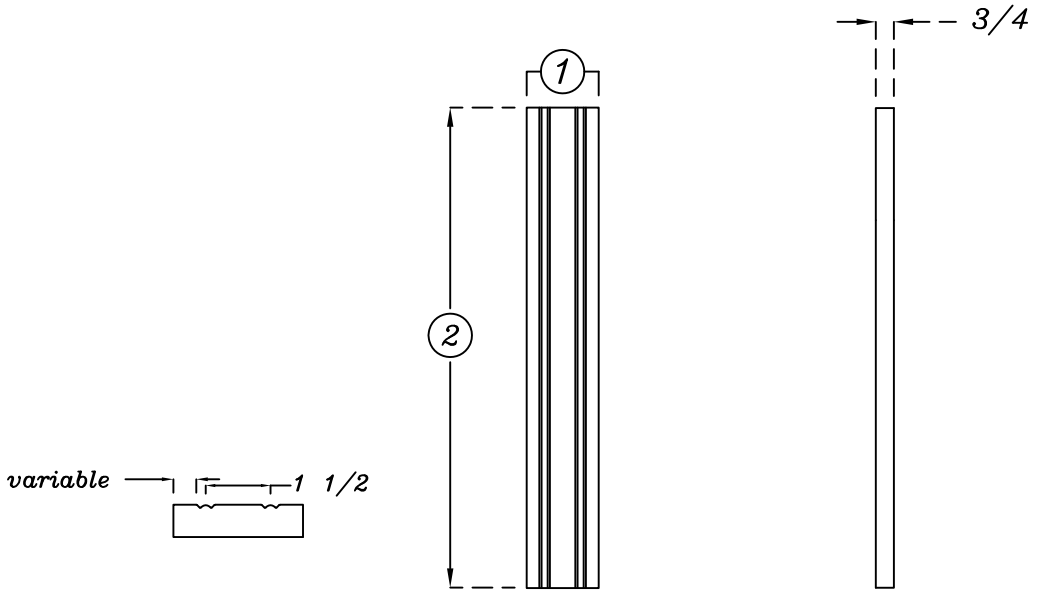

Width ①	Amount of groove
1 7/8" to 2 3/4"	1
2 13/16" to 4 5/16"	2
4 3/8" to 5 3/4"	3
5 13/16" to 6"	4

OPTIONS

①	Width	MINIMUM=2 1/2"
②	Height	MINIMUM=24"
?	Edge profiles	E-01 to E-58
...	Side(s) to be profiled	L=left/R=right/T=top/B=bottom

FL19/ ① ②

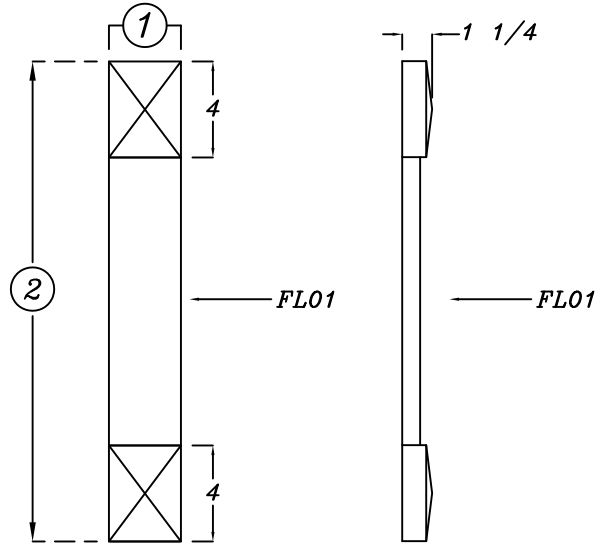

OPTIONS

①	Width	MINIMUM=2 1/2"
②	Height	MINIMUM=24"
?	Edge profiles	E-01 to E-58
...	Side(s) to be profiled	L=left/R=right/T=top/B=bottom

FL20/ ① ②

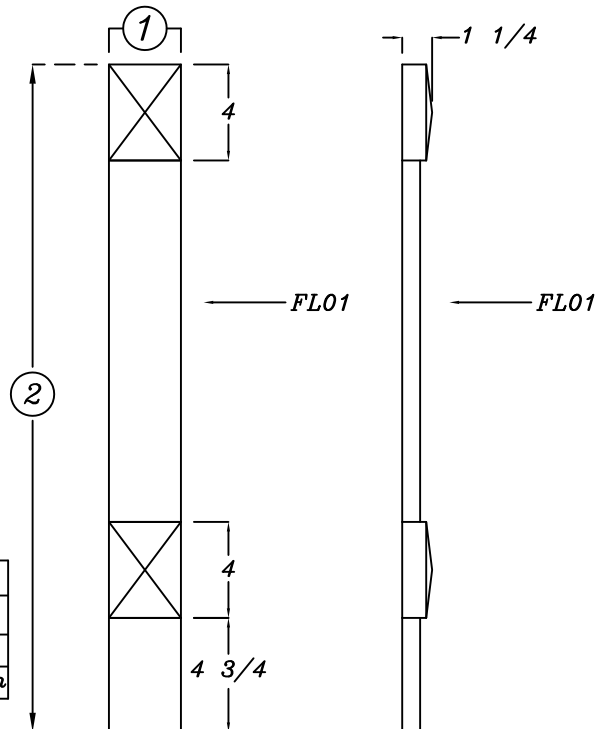

OPTIONS

①	Width	MINIMUM=2 1/2"
②	Height	MINIMUM=24"
?	Edge profiles	E-01 to E-58
...	Side(s) to be profiled	L=left/R=right/T=top/B=bottom

RS01/ ① ② ?

The rosettes are centered on height and on width

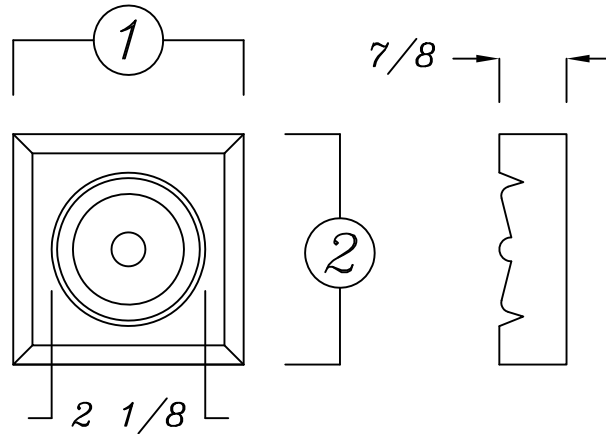

OPTIONS

①	Width	2 1/2" to 5 15/16"
②	Height	2 1/2" to 5 15/16"
?	Edge profiles	E-01 to E-60
...	Side(s) to be profiled	L=left/R=right/T=top/B=bottom

RS02/ ① ② ?

The rosettes are centered on height and on width

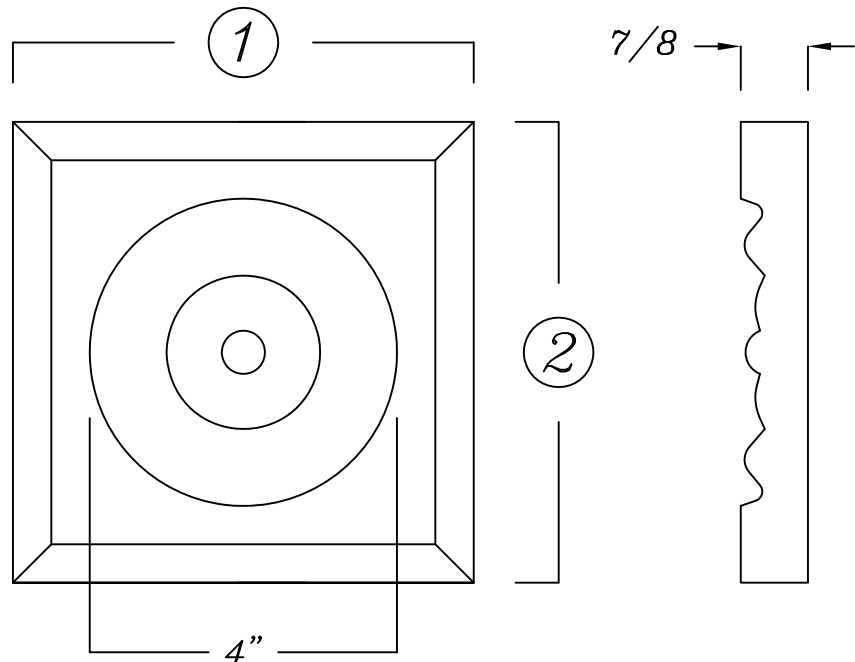

OPTIONS

①	Width	6" to ...
②	Height	6" to ...
?	Edge profiles	E-01 to E-60
...	Side(s) to be profiled	L=left/R=right/T=top/B=bottom

RS03/ ① ②

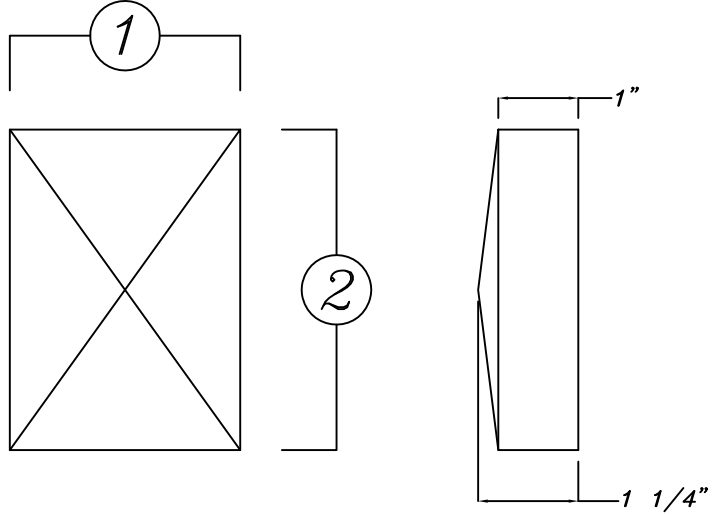

OPTIONS

①	Width	2 1/2" to 6"
②	Height	2 1/2" to 6"

RS04/ ① ② ?

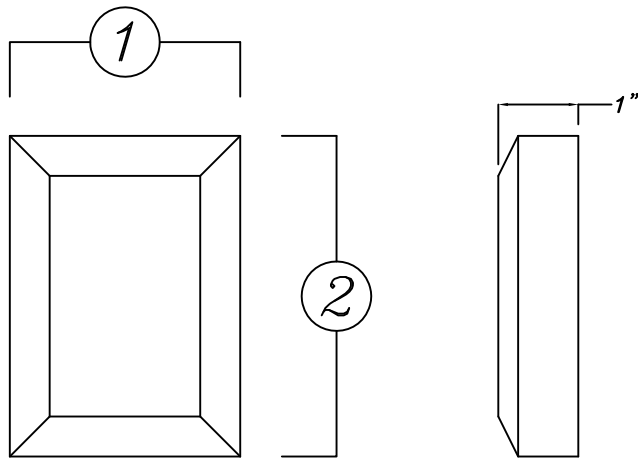

Edge profile shown = E-60

OPTIONS

①	Width	2 1/2" to 6"
②	Height	2 1/2" to 6"
?	Edge profiles	E-01 to E-60
...	Side(s) to be profiled	L=left/R=right/T=top/B=bottom

Speciality products

Valances

1	PROFILES
2	TRADITIONAL 90
3	DISTINCTIVE 90
4	CATHEDRAL 90
5	APPLIED MOULDINGS
6	PRESTIGE 45
7	WAINSCOTS
8	SPECIALITY PRODUCTS
9	MOULDINGS
10	PROMOTIONAL ITEMS
11	POLICY

VL01/ ① ② ?/...

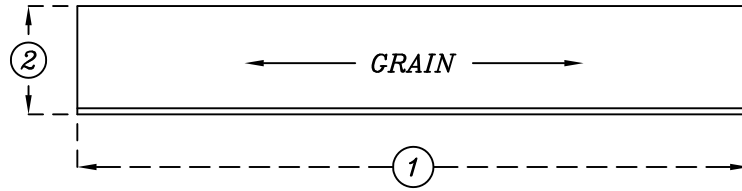

OPTIONS

①	Width	MINIMUM=12"
②	Depth	MINIMUM=3"
?	Edge profiles	E-01 to E-58
...	Side(s) to be profiled	L=left/R=right/T=top/B=bottom

VL02/ ① ② ③ ?/...

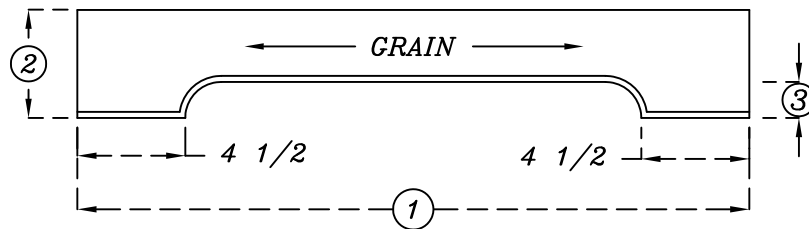

OPTIONS

①	Width	MINIMUM=13 1/2"
②	Depth	MINIMUM=3 1/4"
③	Arch Depth	MINIMUM=1"
?	Edge profiles	E-01 to E-58
...	Side(s) to be profiled	L=left/R=right/T=top/B=bottom

VL03/ ① ② ③ ?/...

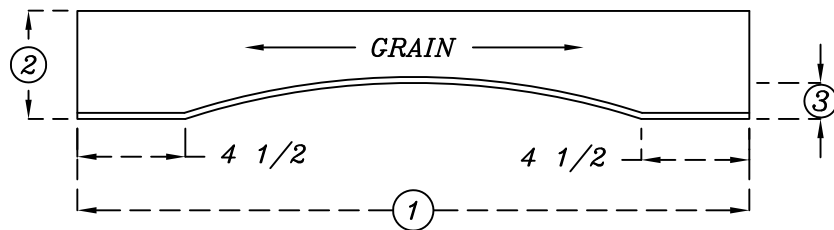

OPTIONS

①	Width	MINIMUM=13 1/2"
②	Depth	MINIMUM=3 1/4"
③	Arch Depth	MINIMUM=1"
?	Edge profiles	E-01 to E-58
...	Side(s) to be profiled	L=left/R=right/T=top/B=bottom

Speciality products

Valances

VL04/ ① ② ③ ?/...

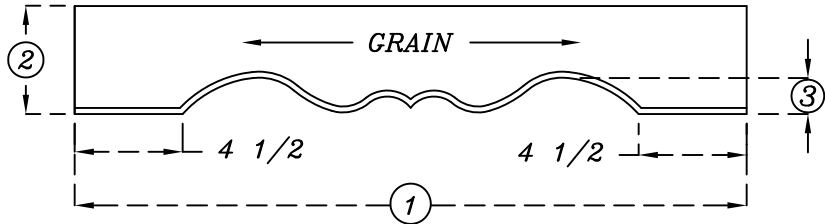

OPTIONS

①	Width	MINIMUM=24"
②	Depth	MINIMUM=3 1/4"
③	Arch Depth	MINIMUM=2"
?	Edge profiles	E-01 to E-58
...	Side(s) to be profiled	L=left/R=right/T=top/B=bottom.

VL05/ ① ② ?/...

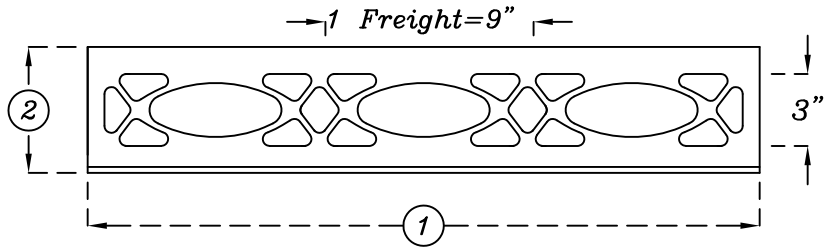

OPTIONS

①	Width	MINIMUM=13 1/2"
②	Depth	MINIMUM=5"
	# of Freights	1 to 10
?	Edge profiles	E-01 to E-58
...	Side(s) to be profiled	L=left/R=right/H=top/B=bottom

Freights are always centered in the piece. Please let us know if you want any other specifications.

VL06/ ① ?/...

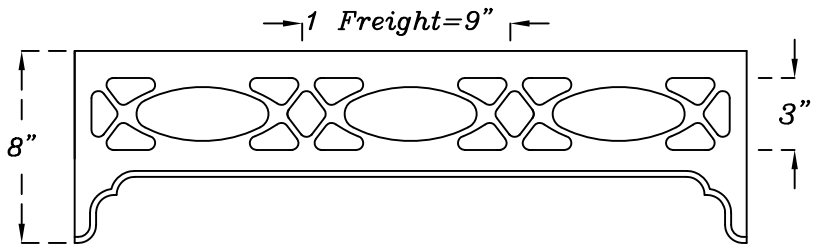

OPTIONS

①	Width	MINIMUM=13 1/2"
	Depth	8"
	# of Freights	1 to 10
?	Edge profiles	E-01 to E-58
...	Side(s) to be profiled	L=left/R=right/T=top/B=bottom

VL07/ ① ② ③ ?/...

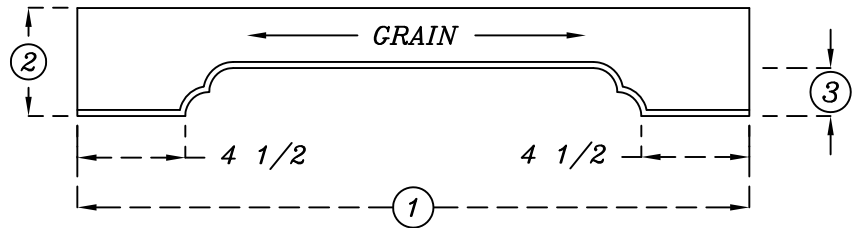

OPTIONS

①	Width	MINIMUM=13 1/2"
②	Depth	MINIMUM=3"
③	Arch Depth	MINIMUM=1 3/4"
?	Edge profiles	E-01 to E-58
...	Side(s) to be profiled	L=left/R=right/T=top/B=bottom

VL08/ ① ② ③ ?/...

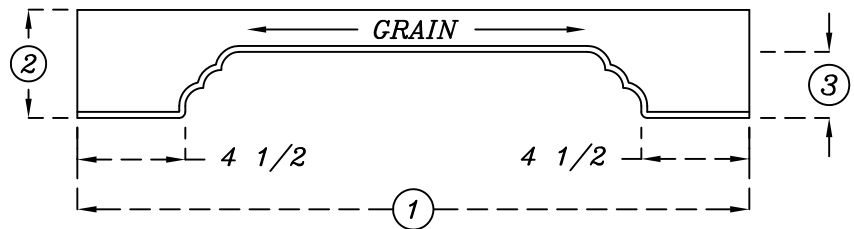

OPTIONS

①	Width	MINIMUM=13 1/2"
②	Depth	MINIMUM=3 3/4"
③	Arch Depth	MINIMUM=2"
?	Edge profiles	E-01 to E-58
...	Side(s) to be profiled	L=left/R=right/T=top/B=bottom

VL09/ ① ② ③ ?/...

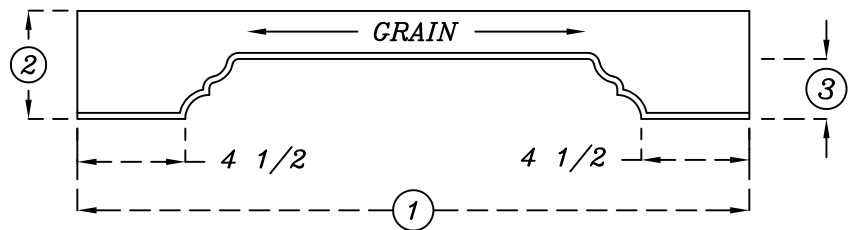

OPTIONS

①	Width	MINIMUM=14"
②	Depth	MINIMUM=3 1/2"
③	Arch Depth	MINIMUM=2 1/2"
?	Edge profiles	E-01 to E-58
...	Side(s) to be profiled	L=left/R=right/T=top/B=bottom

VL10/ ① ② ③ ?/...

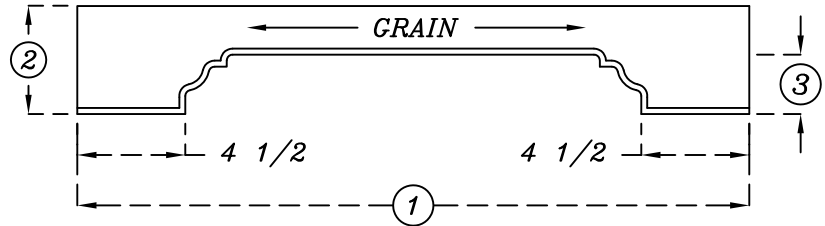

OPTIONS

①	Width	MINIMUM=13 1/2"
②	Depth	MINIMUM=3"
③	Arch Depth	MINIMUM=2 1/2"
?	Edge profiles	E-01 to E-58
...	Side(s) to be profiled	L=left/R=right/T=top/B=bottom.

VL11/ ① ② ③ ?/...

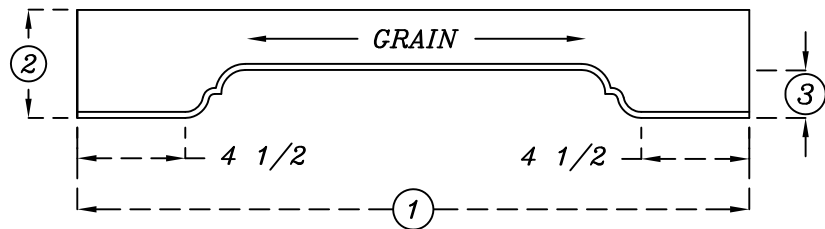

OPTIONS

①	Width	MINIMUM=13 1/2"
②	Depth	MINIMUM=3 3/4"
③	Arch Depth	MINIMUM=1 1/2"
?	Edge profiles	E-01 to E-58
...	Side(s) to be profiled	L=left/R=right/T=top/B=bottom.

Speciality products

Wood supports

1	PROFILES
2	TRADITIONAL 90
3	DISTINCTIVE 90
4	CATHEDRAL 90
5	APPLIED MOULDINGS
6	PRESTIGE 45
7	WAINSCOTS
8	SPECIALITY PRODUCTS
9	MOULDINGS
10	PROMOTIONAL ITEMS
11	POLICY

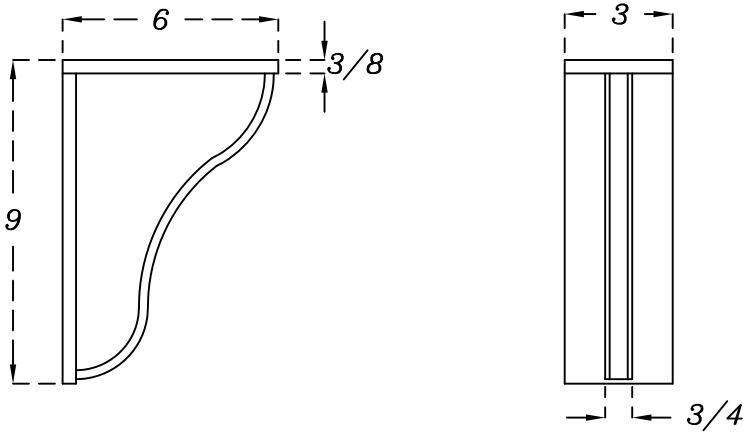
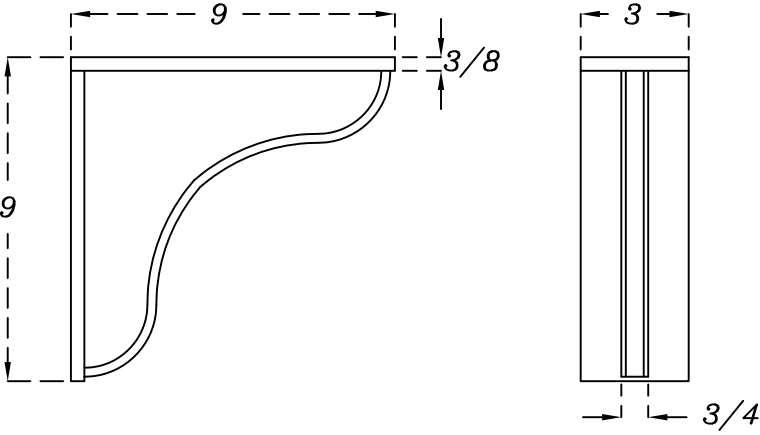
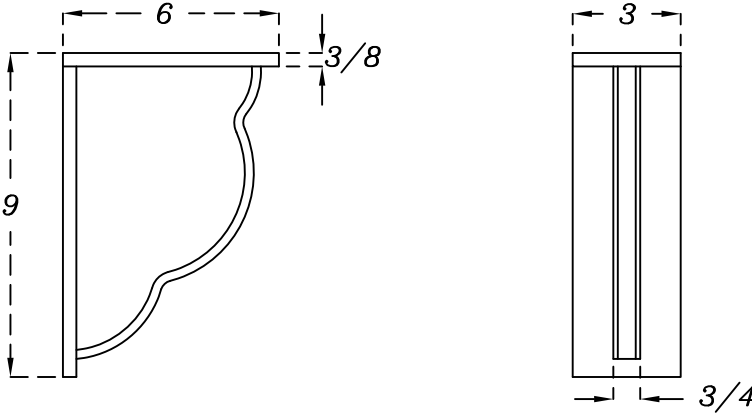
<p><i>SUP1/?</i></p>	 <p><i>OPTIONS</i></p> <table border="1"> <tr> <td>?</td> <td><i>Edge profiles</i></td> <td><i>E-01 to E-58</i></td> </tr> </table>	?	<i>Edge profiles</i>	<i>E-01 to E-58</i>
?	<i>Edge profiles</i>	<i>E-01 to E-58</i>		
<p><i>SUP2/?</i></p>	 <p><i>OPTIONS</i></p> <table border="1"> <tr> <td>?</td> <td><i>Edge profiles</i></td> <td><i>E-01 to E-58</i></td> </tr> </table>	?	<i>Edge profiles</i>	<i>E-01 to E-58</i>
?	<i>Edge profiles</i>	<i>E-01 to E-58</i>		
<p><i>SUP3/?</i></p>	 <p><i>OPTIONS</i></p> <table border="1"> <tr> <td>?</td> <td><i>Edge profiles</i></td> <td><i>E-01 to E-58</i></td> </tr> </table>	?	<i>Edge profiles</i>	<i>E-01 to E-58</i>
?	<i>Edge profiles</i>	<i>E-01 to E-58</i>		

SUP4/?

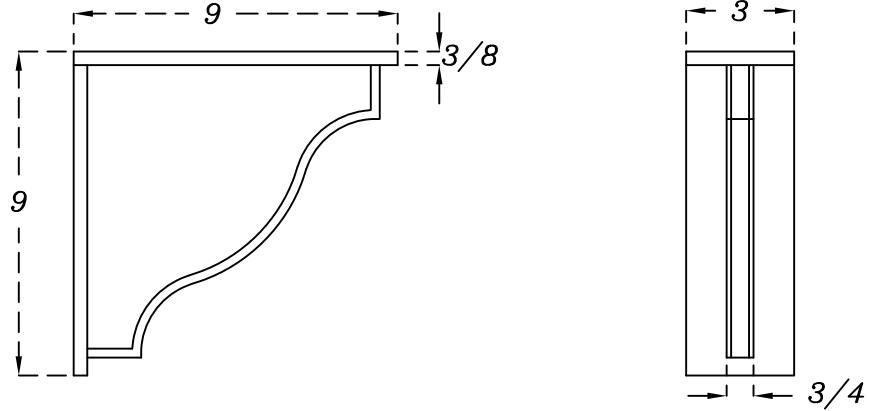

OPTIONS

? Edge profiles E-01 to E-58

SUP5/?

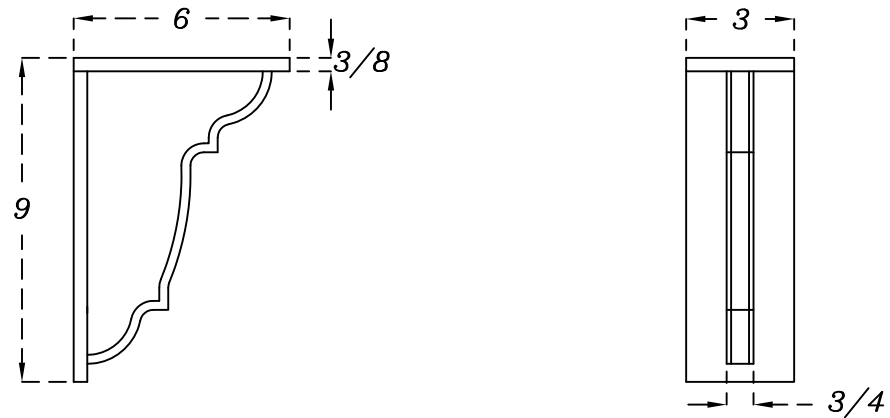

OPTIONS

? Edge profiles E-01 to E-58

SUP6/?

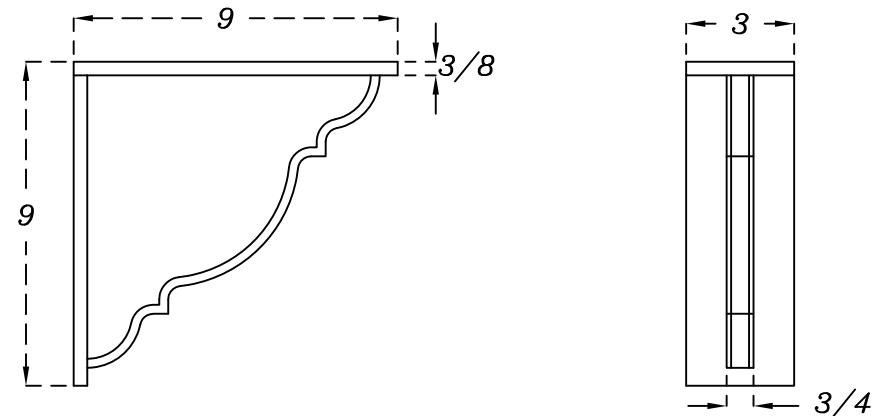

OPTIONS

? Edge profiles E-01 to E-58

Speciality products

Wood supports

1	PROFILES
2	TRADITIONAL 90
3	DISTINCTIVE 90
4	CATHEDRAL 90
5	APPLIED MOULDINGS
6	PRESTIGE 45
7	WAINSCOTS
8	SPECIALITY PRODUCTS
9	MOULDINGS
10	PROMOTIONAL ITEMS
11	POLICY

SUP7/?

OPTIONS

?	Edge profiles	E-01 to E-58
---	---------------	--------------

SUP8/?

OPTIONS

?	Edge profiles	E-01 to E-58
---	---------------	--------------

SUP9/?

OPTIONS

?	Edge profiles	E-01 to E-58
---	---------------	--------------

Speciality products

Wood supports

SUP10/?

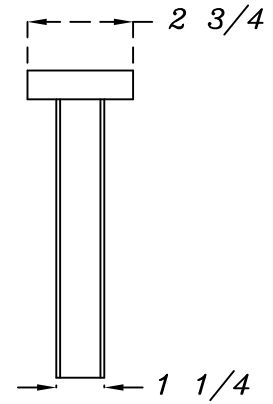
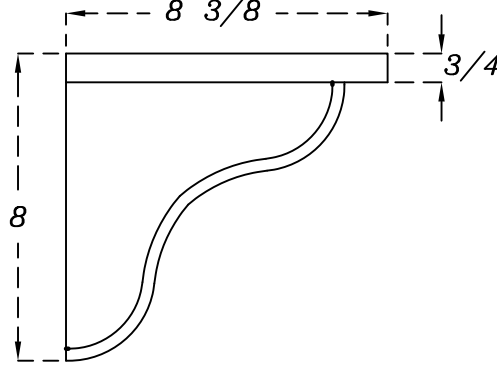

OPTIONS

? Edge profiles E-01 to E-58

SUP11/?

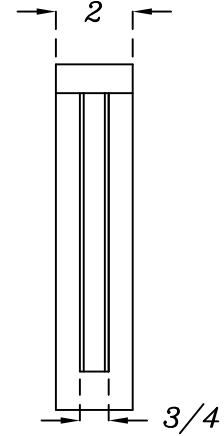
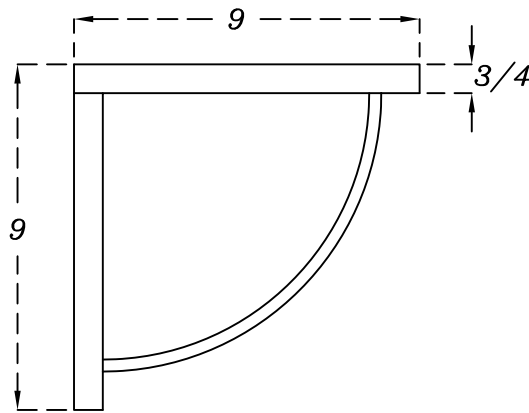

OPTIONS

? Edge profiles E-01 to E-58

SUP12/?

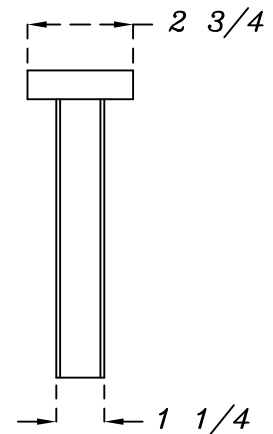
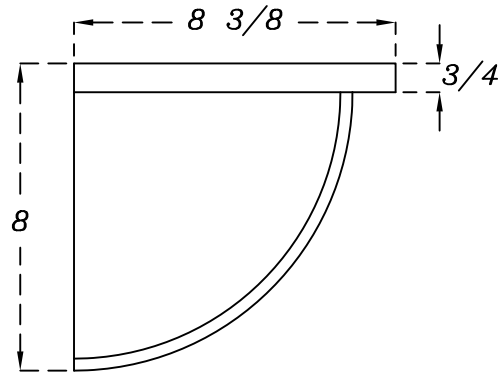

OPTIONS

? Edge profiles E-01 to E-58

Speciality products

Wood supports

1	PROFILES
2	TRADITIONAL 90
3	DISTINCTIVE 90
4	CATHEDRAL 90
5	APPLIED MOULDINGS
6	PRESTIGE 45
7	WANNSCOTS
8	SPECIALITY PRODUCTS
9	MOULDINGS
10	PROMOTIONAL ITEMS
11	POLICY

SUP13/?

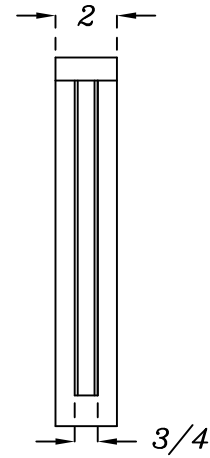
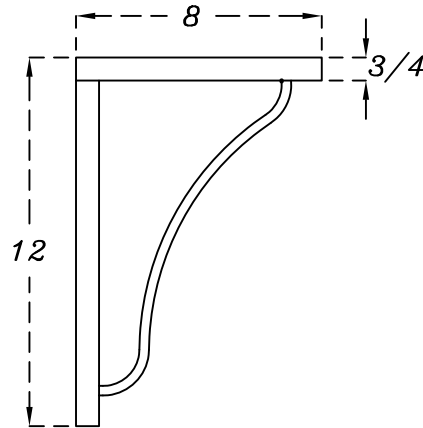

OPTIONS

?	Edge profiles	E-01 to E-58
---	---------------	--------------

SUP14/?

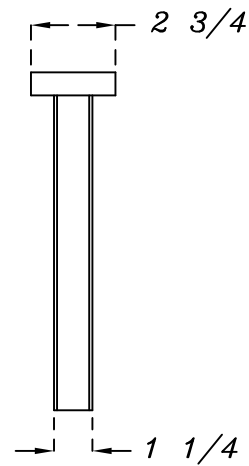
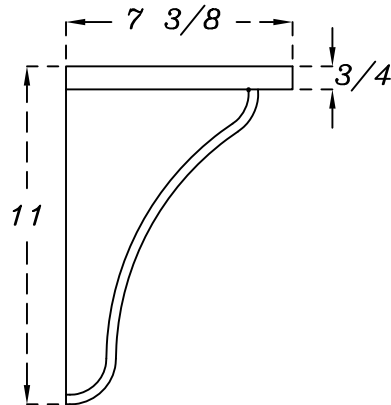

OPTIONS

?	Edge profiles	E-01 to E-58
---	---------------	--------------

SUP15/?

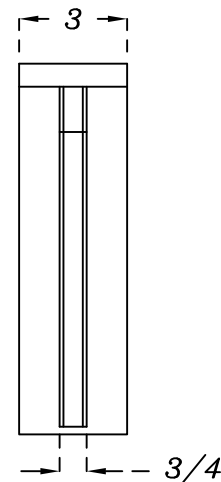
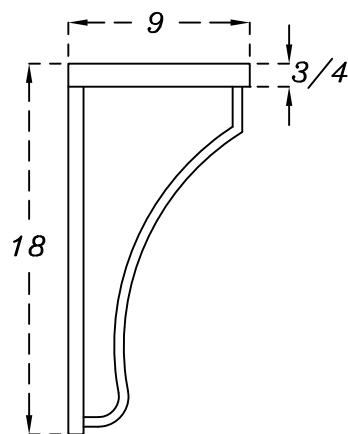

OPTIONS

?	Edge profiles	E-01 to E-58
---	---------------	--------------

SUP16/?

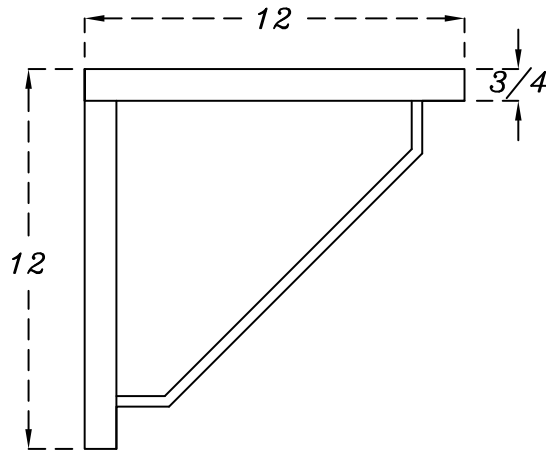

OPTIONS

? Edge profiles E-01 to E-58

SUP17/?

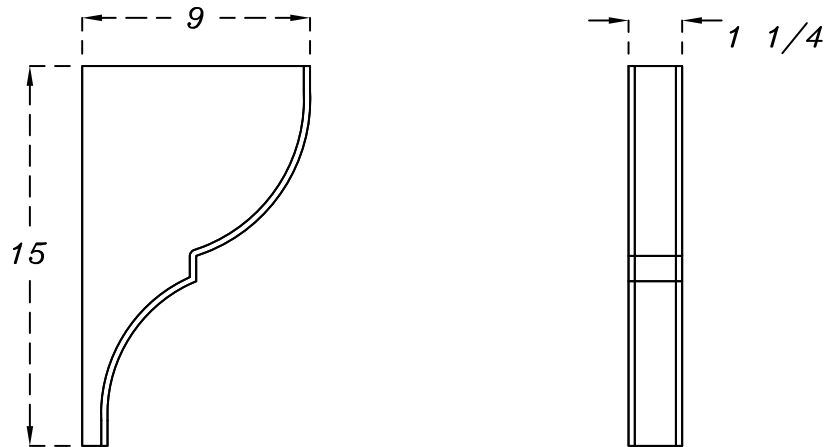

OPTIONS

? Edge profiles E-01 to E-58

SUP18/?

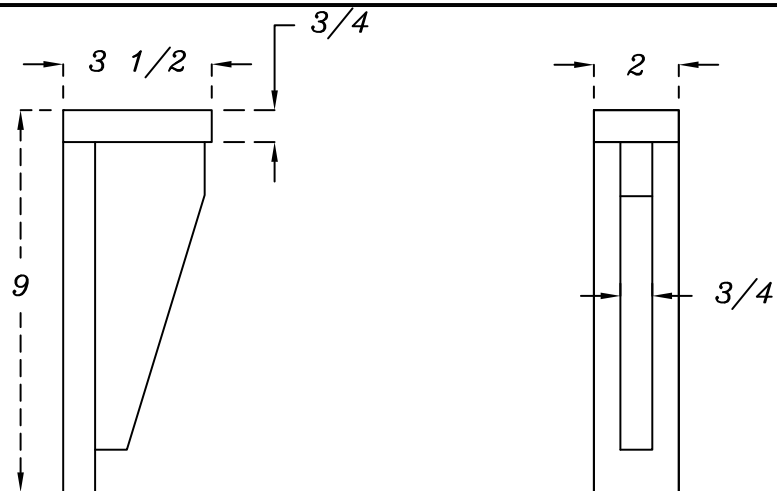

OPTIONS

? Edge profiles E-01 to E-58

SUP19/?

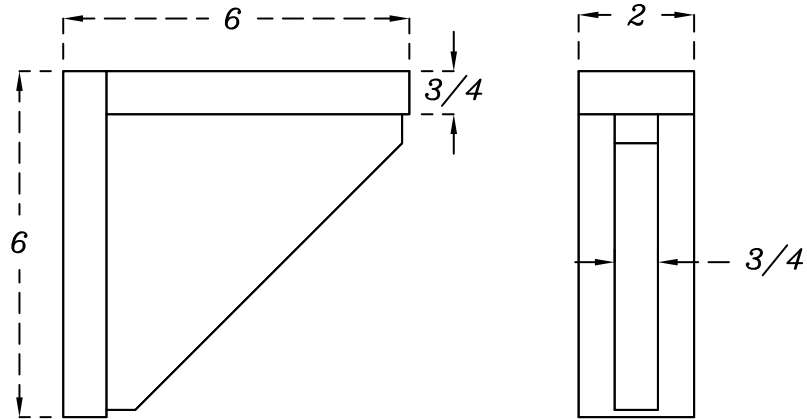

OPTIONS

? Edge profiles E-01 to E-58

SUP20/?

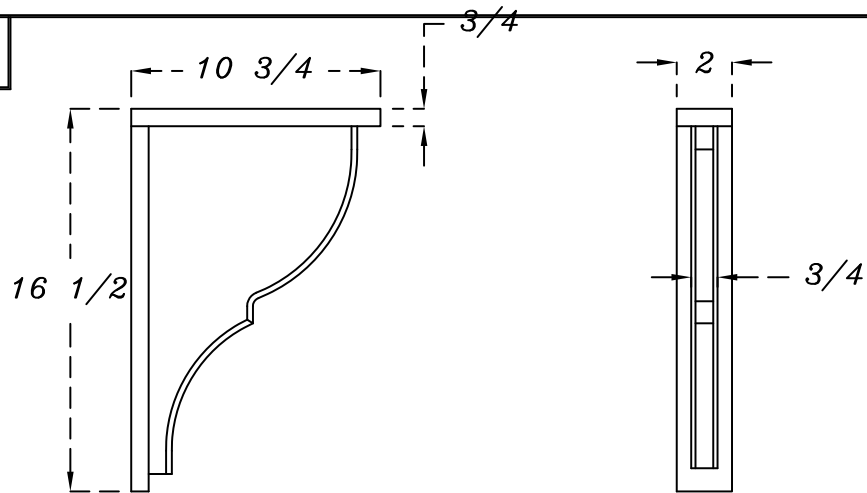

OPTIONS

? Edge profiles E-01 to E-58

SUP21/?

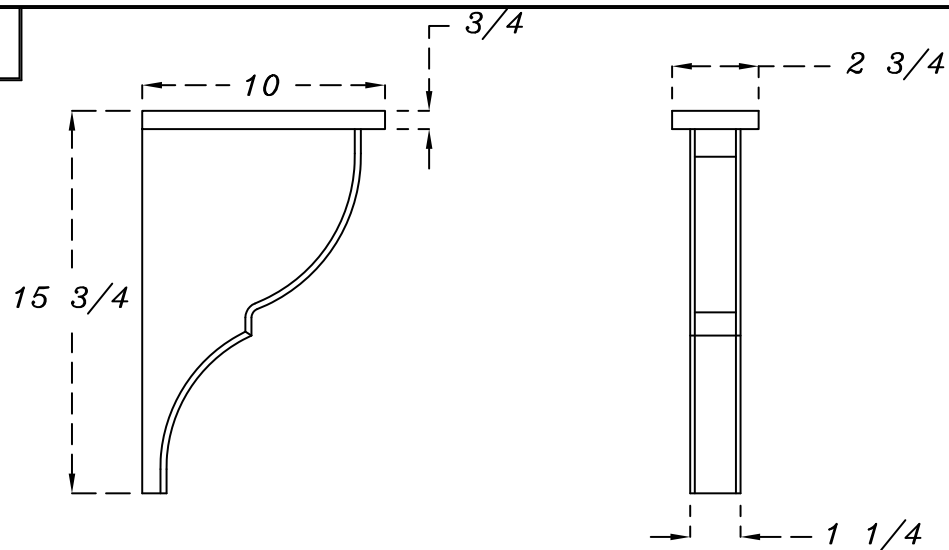

OPTIONS

? Edge profiles E-01 to E-58

Speciality products

Wood supports

SUP22/?

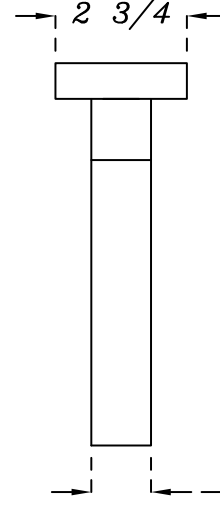
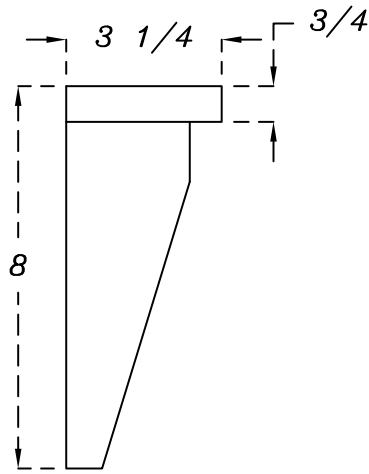

OPTIONS

? Edge profiles E-01 to E-58

SUP23/?

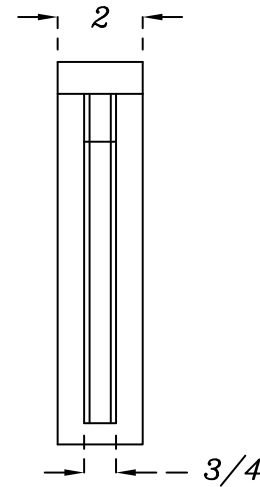
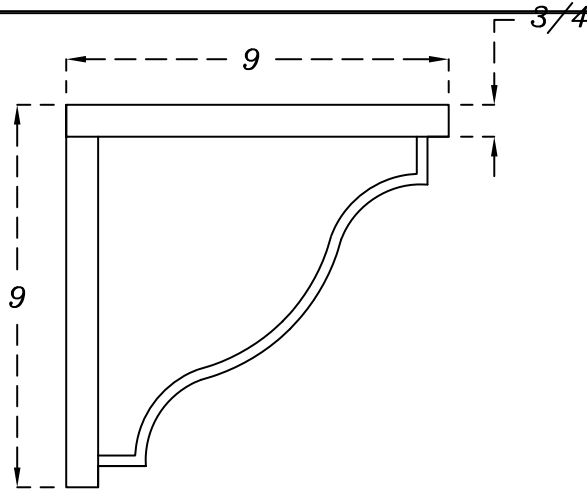

OPTIONS

? Edge profiles E-01 to E-58

SUP24/?

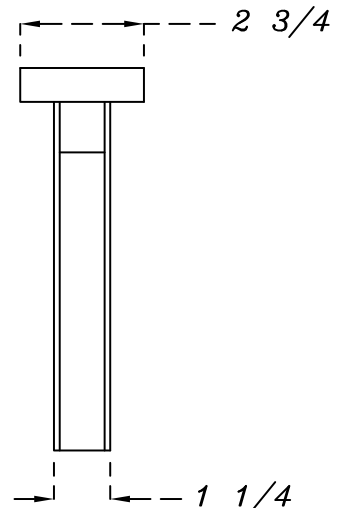
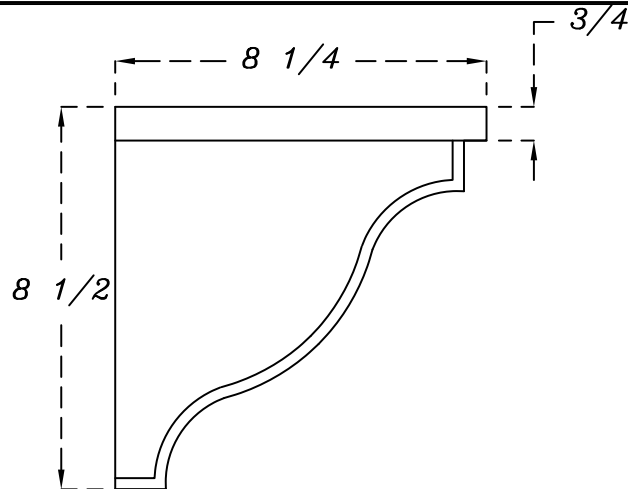

OPTIONS

? Edge profiles E-01 to E-58

SUP25/?

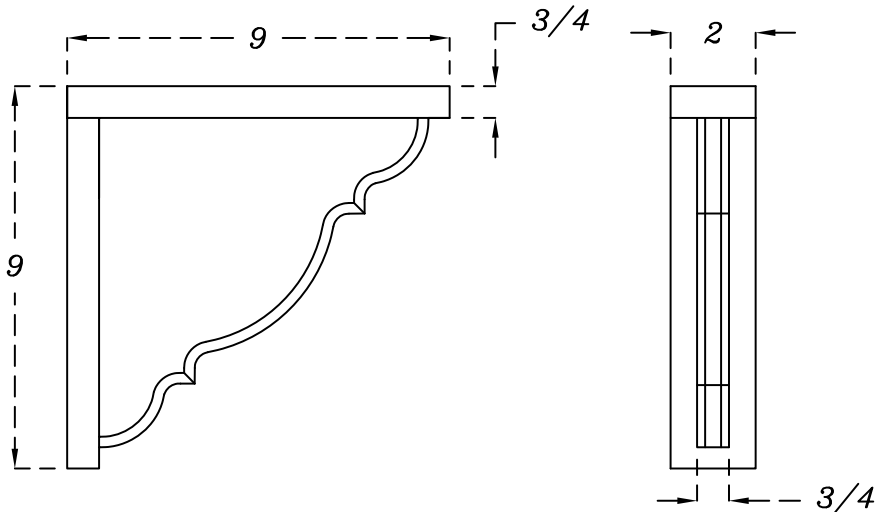

OPTIONS

? Edge profiles E-01 to E-58

SUP26/?

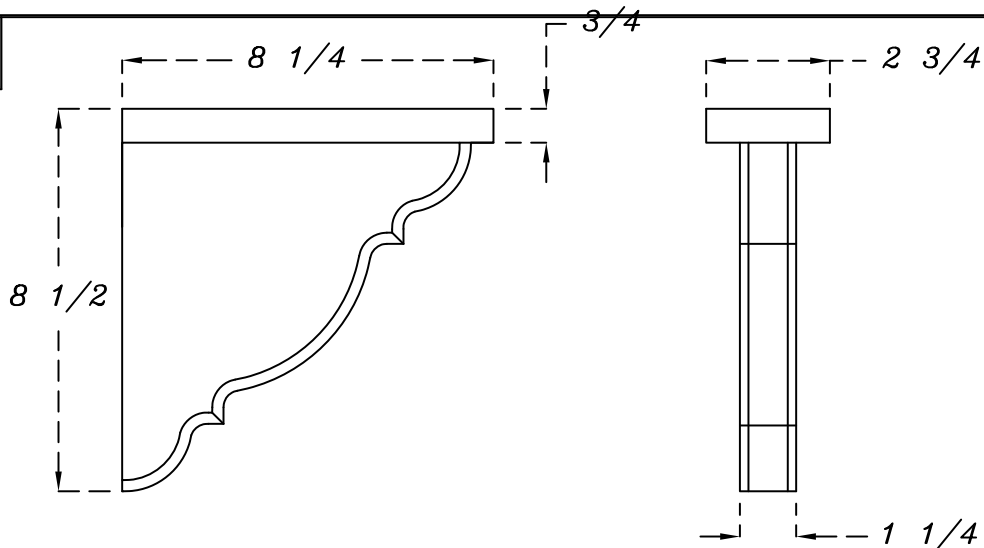

OPTIONS

? Edge profiles E-01 to E-58

SUP27/?

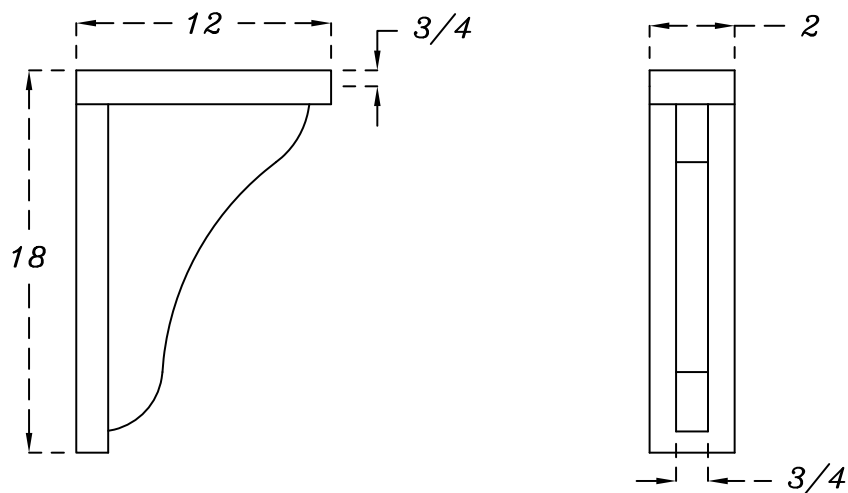

OPTIONS

? Edge profiles E-01 to E-58

Speciality products

Wood supports

SUP28/?

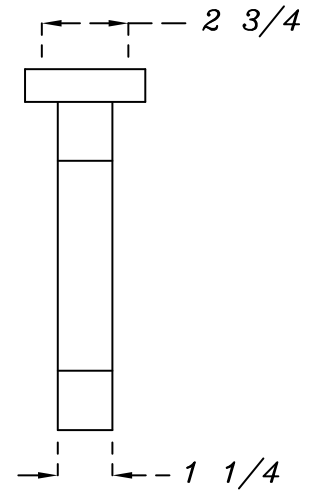
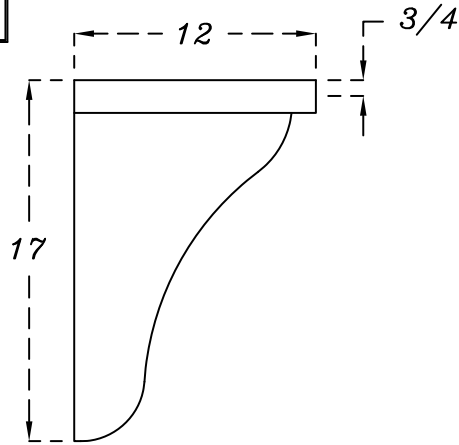

OPTIONS

?	Edge profiles	E-01 to E-58
---	---------------	--------------

SUP29/?

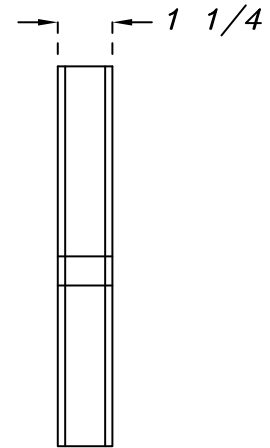
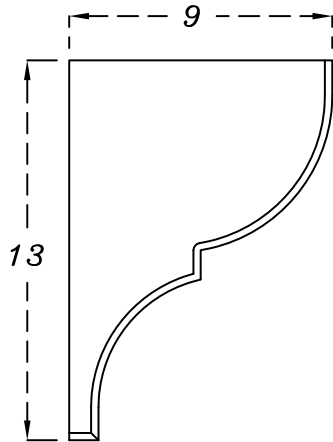

OPTIONS

?	Edge profiles	E-01 to E-58
---	---------------	--------------

SUP30

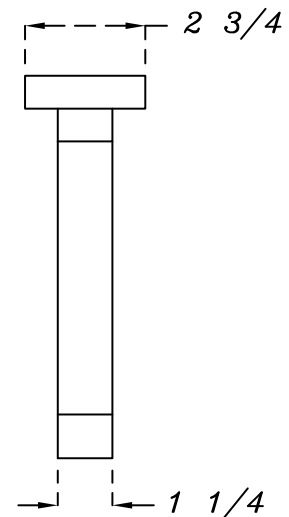
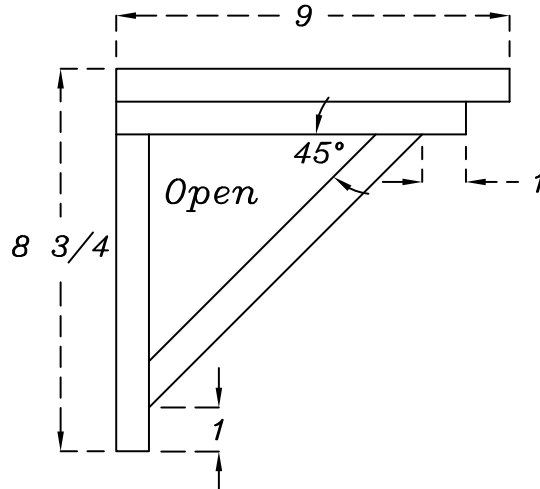

OPTIONS

?	Edge profiles	E-01 Only
---	---------------	-----------

Speciality products

Wood supports

1	PROFILES
2	TRADITIONAL 90
3	DISTINCTIVE 90
4	CATHEDRAL 90
5	APPLIED MOULDINGS
6	PRESTIGE 45
7	WAINSCOTS
8	SPECIALTY PRODUCTS
9	MOULDINGS
10	PROMOTIONAL ITEMS
11	POLICY

SUP31

OPTIONS

?	Edge profiles	E-01 Only
---	---------------	-----------

SUP32/?

OPTIONS

?	Edge profiles	E-01 to E-58
---	---------------	--------------

SUCB 8X8/?

OPTIONS

?	Edge profiles	E-01 to E-58
---	---------------	--------------

SUCB 6X9/?

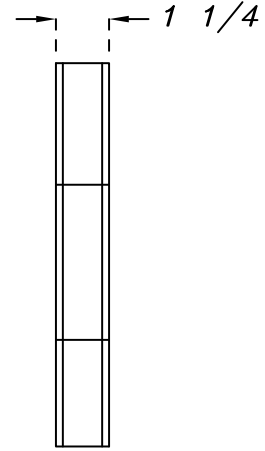
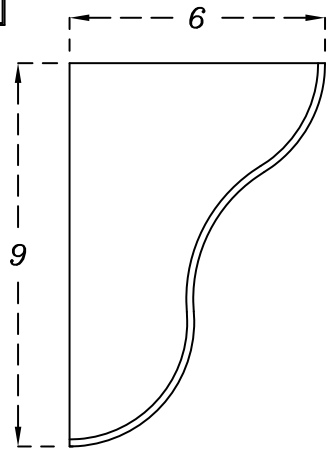

OPTIONS

? Edge profiles E-01 to E-58

SUCB 9X9/?

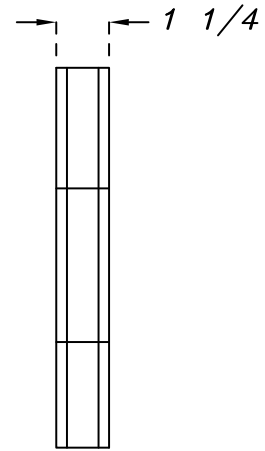
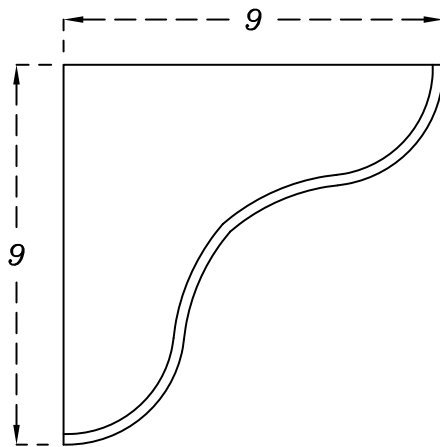

OPTIONS

? Edge profiles E-01 to E-58

SUCC 6X6/?

Profiled back and mitered assembly

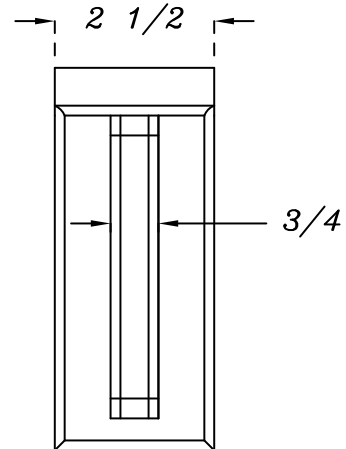
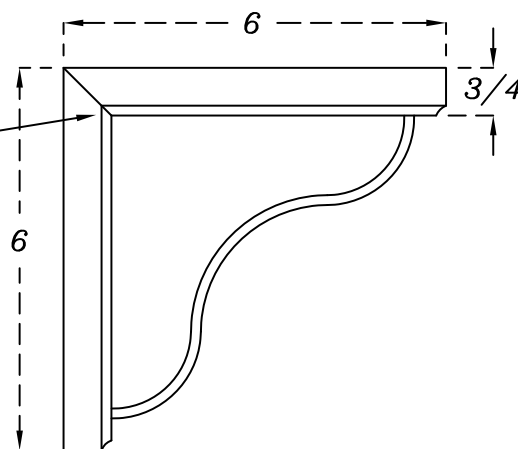

OPTIONS

? Edge profiles E-01 to E-58

SUCC 9X9/?

Profiled back and mitered assembly

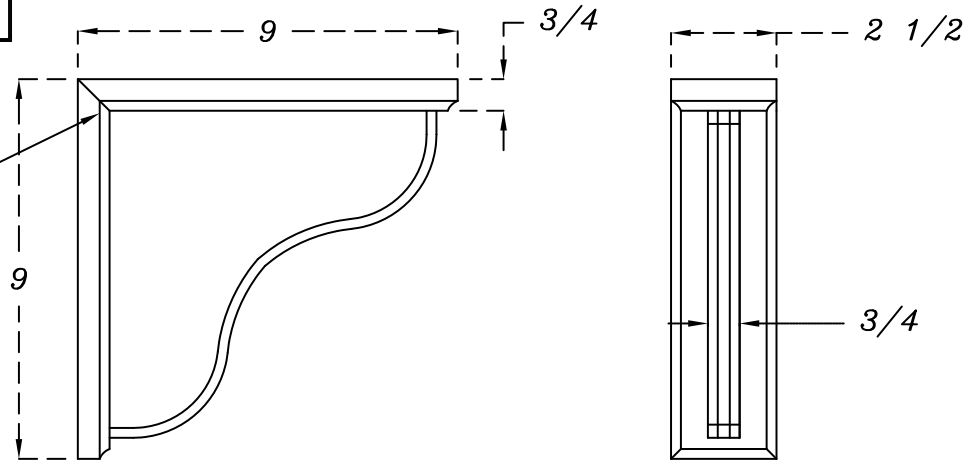

OPTIONS

?	Edge profiles	E-01 to E-58
---	---------------	--------------

SUCC 12X12/?

Profiled back and mitered assembly

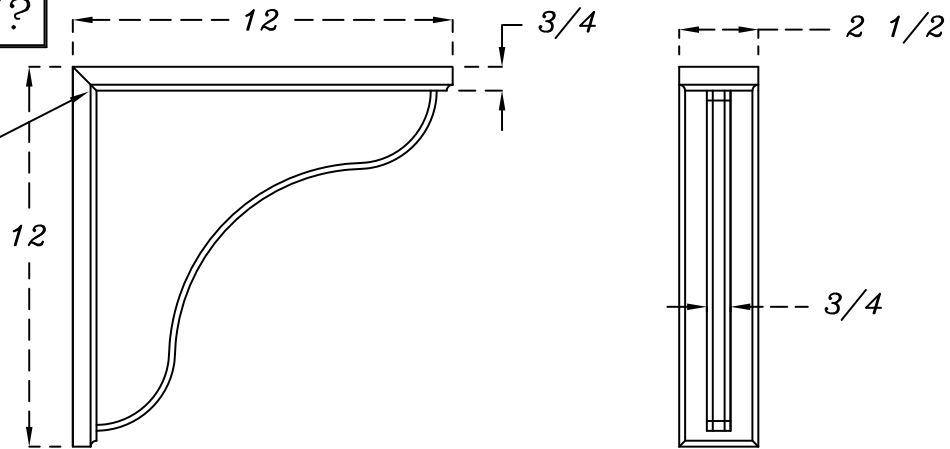

OPTIONS

?	Edge profiles	E-01 to E-58
---	---------------	--------------

PCPS4 9X9/?

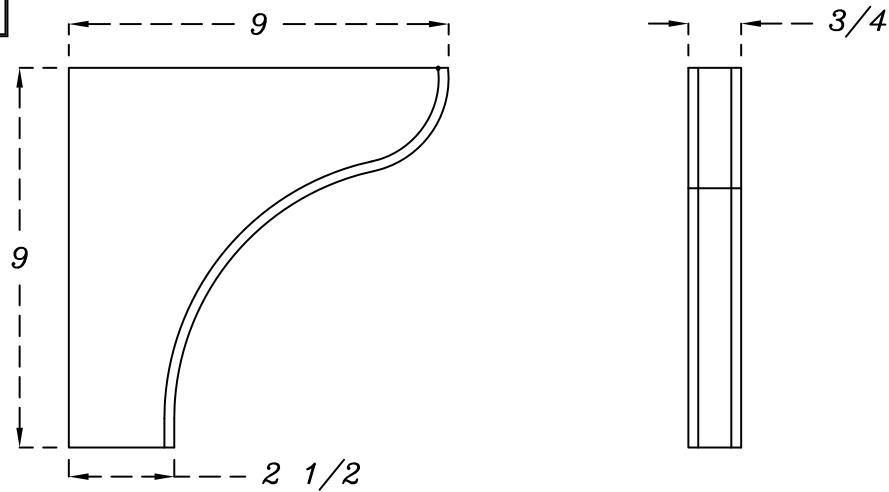

OPTIONS

?	Edge profiles	E-01 to E-58
---	---------------	--------------

1	PROFILES
2	TRADITIONAL 90
3	DISTINCTIVE 90
4	CATHEDRAL 90
5	APPLIED MOULDINGS
6	PRESTIGE 45
7	WAINSCOTS
8	SPECIALTY PRODUCTS
9	MOULDINGS
10	PROMOTIONAL ITEMS
11	POLICY

PCPS4/?

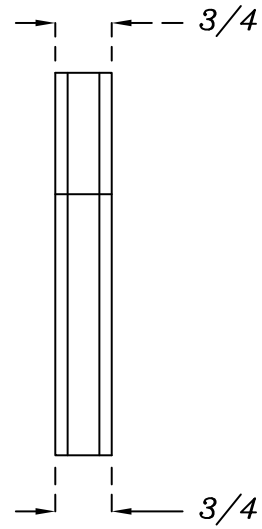
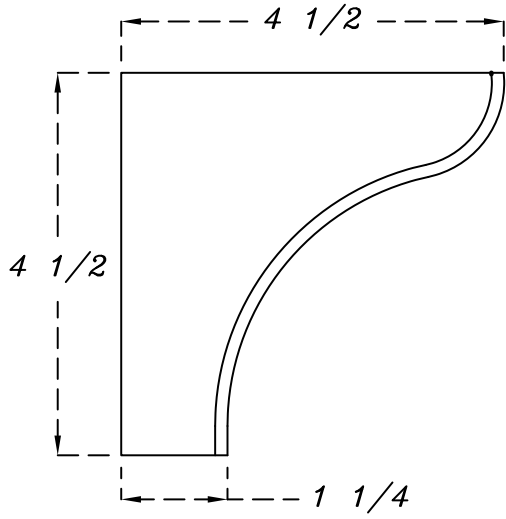

OPTIONS

?	Edge profiles	E-01 to E-58
---	---------------	--------------

PCPD4/?

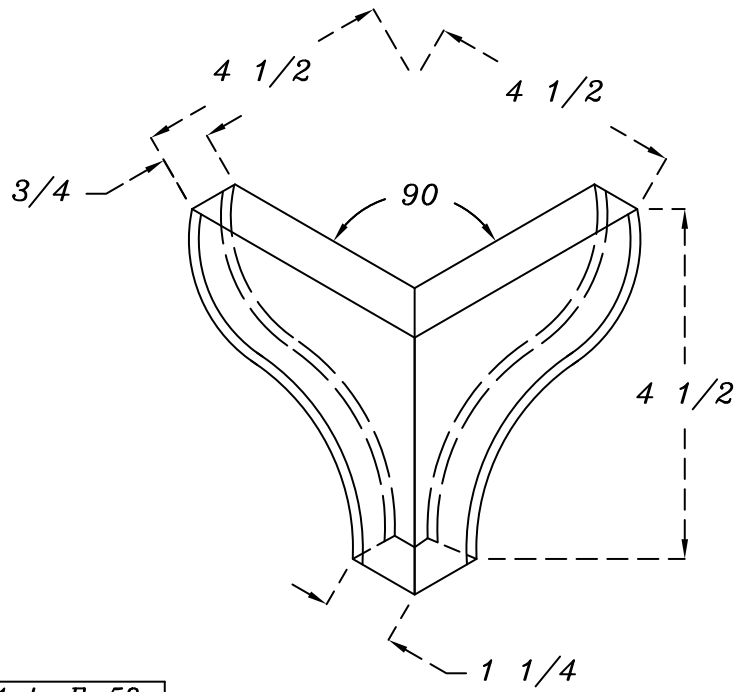

OPTIONS

?	Edge profiles	E-01 to E-58
---	---------------	--------------

P95/ ① ② /FL??...

*Empty center
and mitered
assembly*

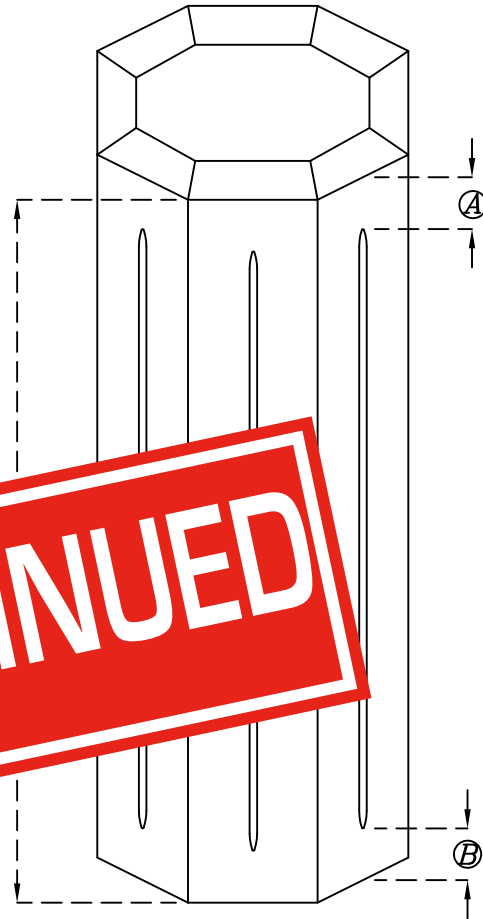
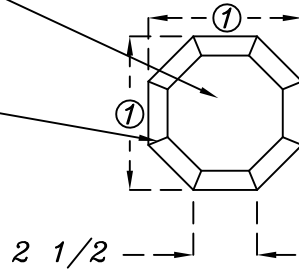

Made of 3/4" hard wood

OPTION

①	Width	6"
②	Height	12" to 96"

One flute available per side

P96/ (1) (2)

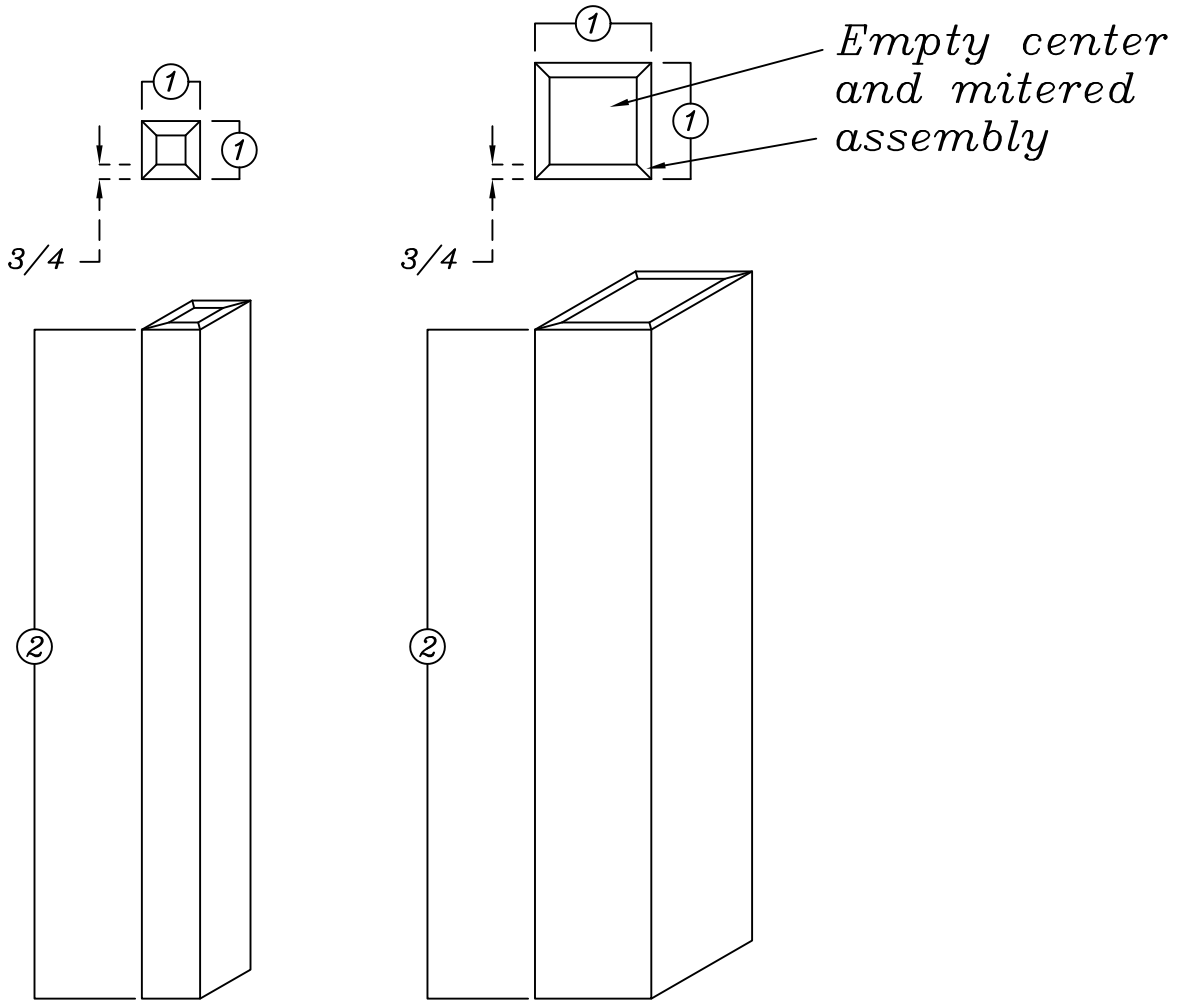

Made of 3/4" hard wood

OPTIONS

①	Width	3" to 6"
②	Height	12" to 96"

P97/ ① ② /AM ...

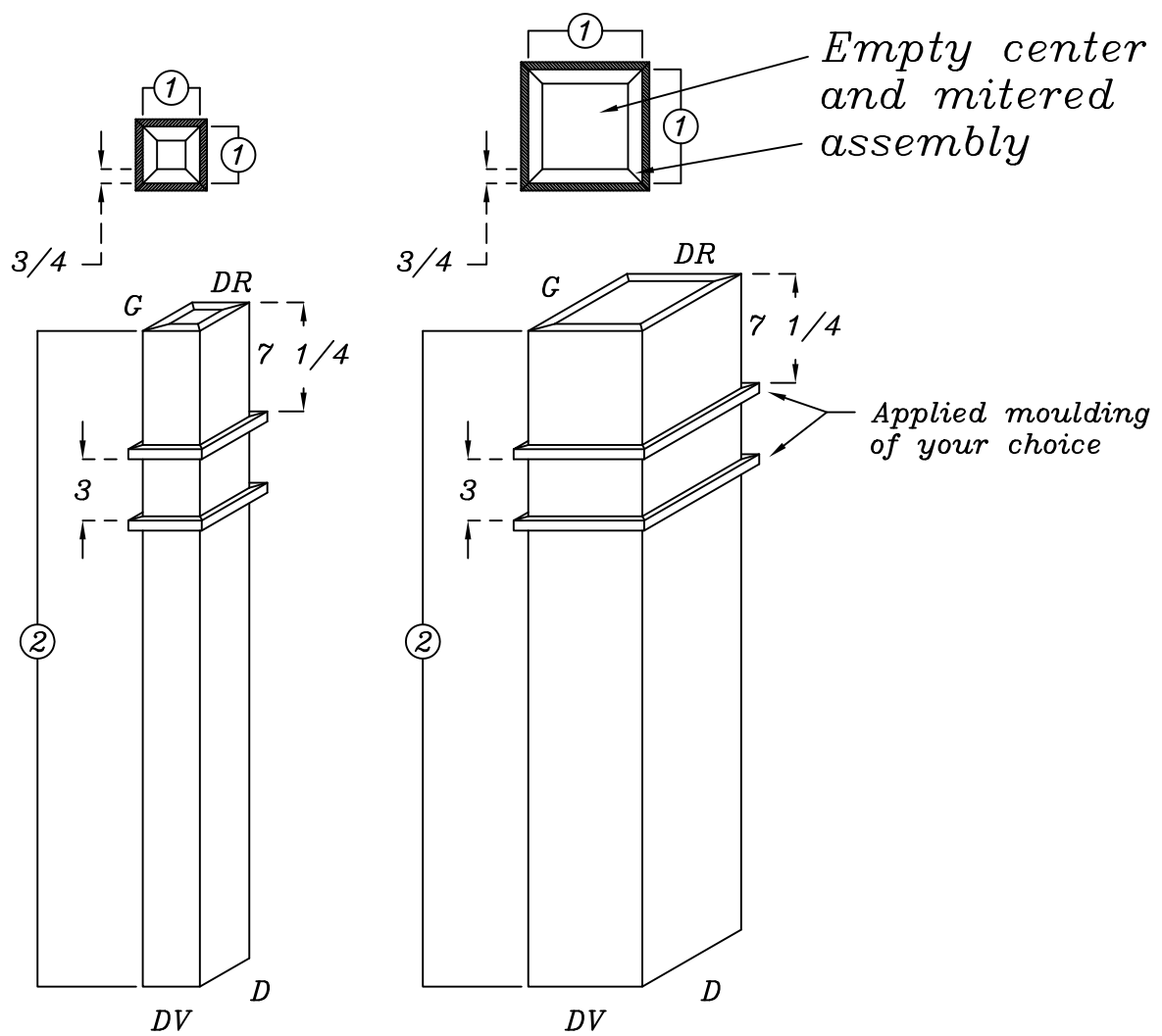

Made of 3/4" hard wood

OPTIONS

①	Width	3" to 6"
②	Height	12" to 96"
AM	Please refer to the "Applied Mouldings" section for your choice of mouldings	
...	Identify the side you want the applied mouldings F=front/L=left/R=right/B=back	

Speciality products

Wood posts

P98/ ① ② ...

Empty center and mitered assembly

Made of $\frac{3}{4}$ " hard wood. The grooves are the same as the panel P-13 so there is $1 \frac{1}{2}$ " between center to center

OPTIONS

①	Width	3" to 6"
②	Height	12" to 96"
...	Identify which side you want to be grooved F=front/L=left/R=right/B=back	

Width ①	Number of grooves
3 to 4"	2
4 $\frac{1}{16}$ " to 5 $\frac{15}{16}$ "	3
6"	4

P99/ ① ② /FL??...

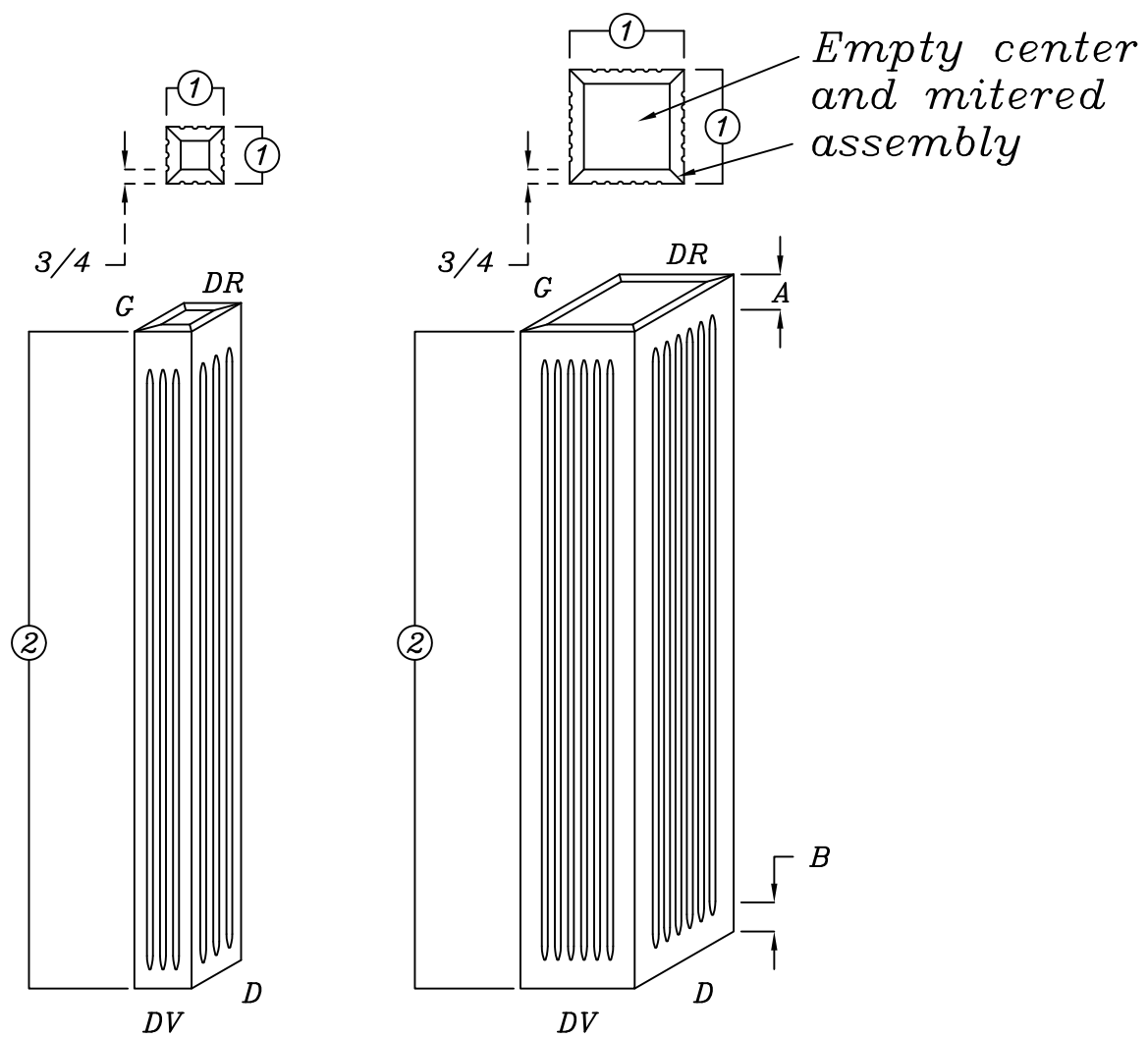

Made of 3/4" hard wood. Please refer to the Overlay Fillers section for your choice of flutes

OPTIONS

①	Width	3" to 6"
②	Height	12" to 96"
...	Identify the side you want the flutes to be done F=front/L=left/R=right/B=back	

Speciality products

Wood posts

P100/ ① ② ?

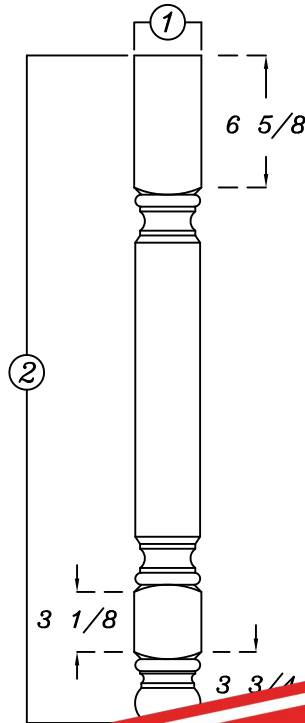

OPTIONS

①	Width	3" - 3 1/2" - 4"
②	Height	28 1/2" to 42"
?	Type	A/B/C

TYPE A (Full post)
Top view

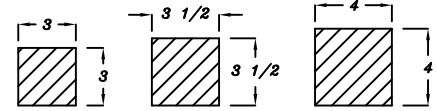

TYPE B (1 Corner post)
Top view

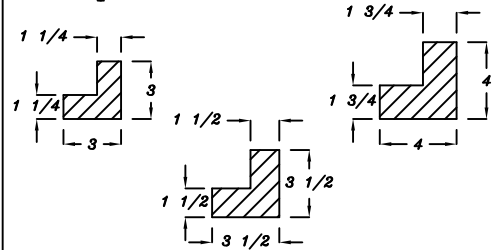

TYPE C (2 half posts)
Top view

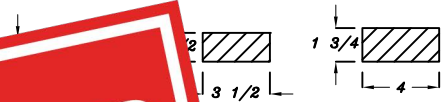

Sold in pairs

P101/ ① ②

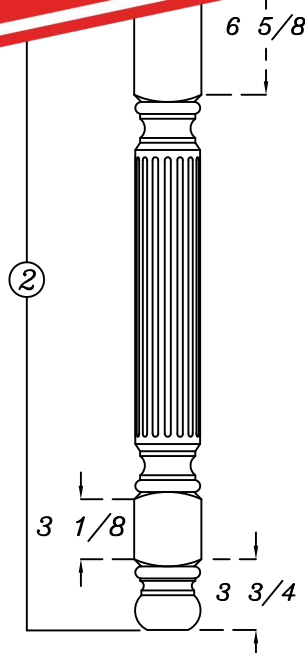

OPTIONS

①	Width	3" - 3 1/2" - 4"
②	Height	28 1/2" to 42"
?	Type	A/B/C

TYPE A (Full post)
Top view

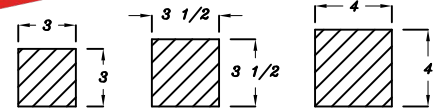

TYPE B (1 Corner post)
Top view

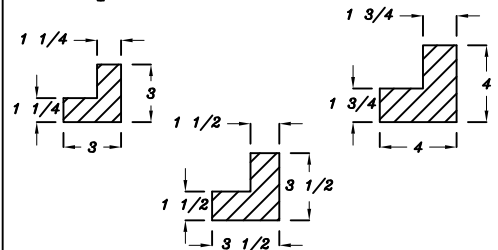

TYPE C (2 half posts)
Top view

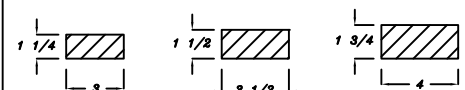

Note: Sold in pairs

Speciality products

Wood posts

1 PROFILES
 2 TRADITIONAL 90
 3 DISTINCTIVE 90
 4 CATHEDRAL 90
 5 APPLIED MOULDINGS
 6 PRESTIGE 45
 7 WAINSCOTS
 8 SPECIALITY PRODUCTS
 9 MOULDINGS
 10 PROMOTIONAL ITEMS
 11 POLICY

P102/ ① ② ?

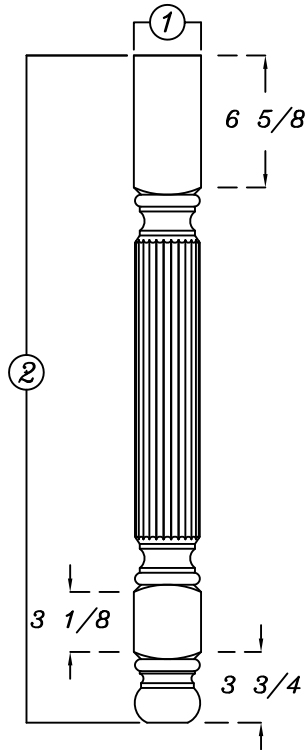

OPTIONS

①	Width	3" - 3 1/2" - 4"
②	Height	28 1/2" to 42"
?	Type	A/B/C

*TYPE A (Full post)
Top view*

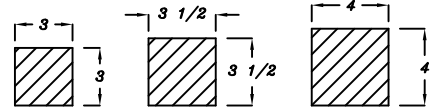

*TYPE B (1 Corner post)
Top view*

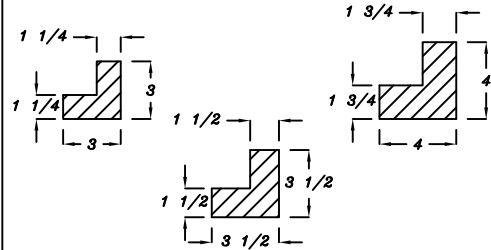

*TYPE C (2 half posts)
Top view*

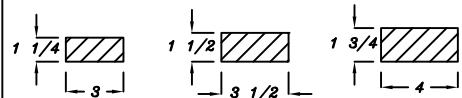

Note: Sold in pairs

P103/ ① ② ?

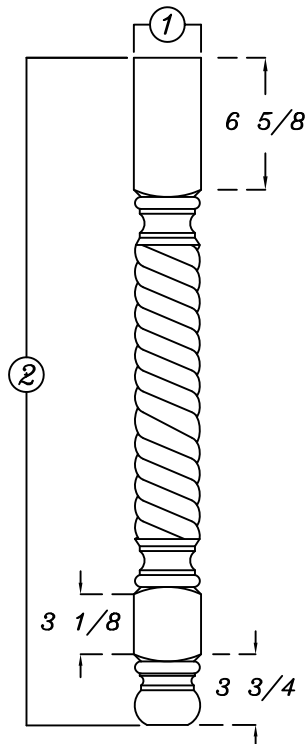

OPTIONS

①	Width	3" - 3 1/2" - 4"
②	Height	28 1/2" to 42"
?	Type	A/B/C

*TYPE A (Full post)
Top view*

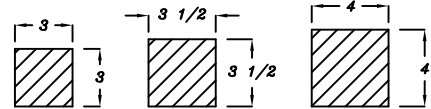

*TYPE B (1 Corner post)
Top view*

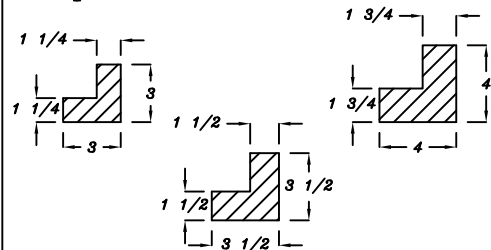

*TYPE C (2 half posts)
Top view*

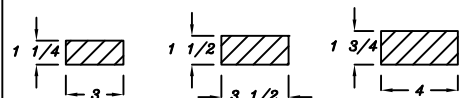

Note: Sold in pairs

Speciality products

Wood posts

P104/ ① ?

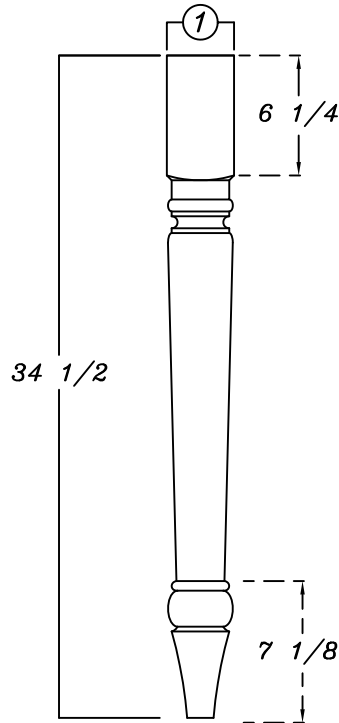

OPTIONS

①	Width	3 1/2" - 4"
	Height	34 1/2"
?	Type	A/B/C

TYPE A (Full post)
Top view

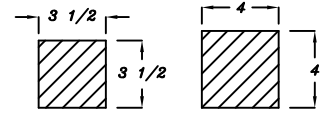

TYPE B (1 Corner post)
Top view

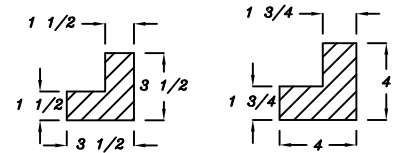

TYPE C (2 half posts)
Top view

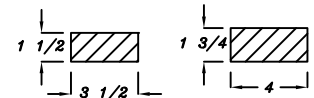

Note: Sold in pairs

P105/ ① ?

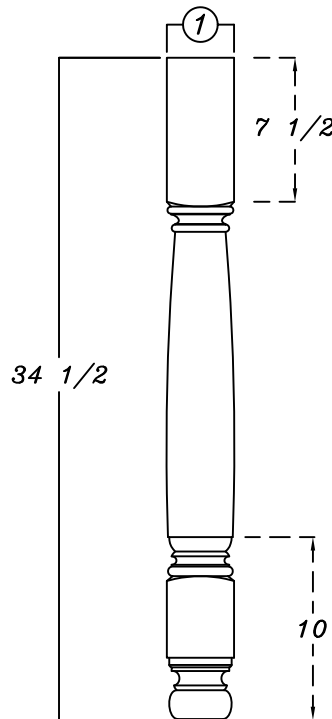

OPTIONS

①	Width	3" - 3 1/2" - 4"
	Height	34 1/2"
?	Type	A/B/C

TYPE A (Full post)
Top view

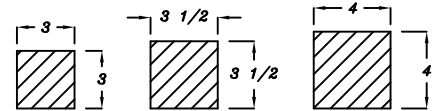

TYPE B (1 Corner post)
Top view

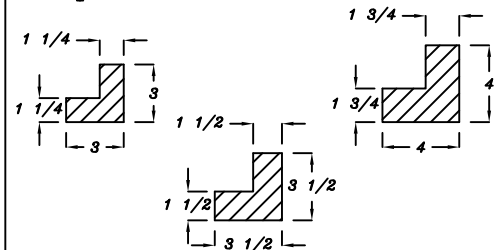

TYPE C (2 half posts)
Top view

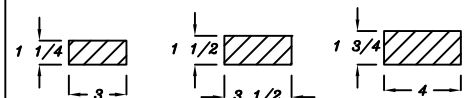

Note: Sold in pairs

Speciality products

Wood posts

1 PROFILES
 2 TRADITIONAL 90
 3 DISTINCTIVE 90
 4 CATHEDRAL 90
 5 APPLIED MOULDINGS
 6 PRESTIGE 45
 7 WANNSCOTS
 8 SPECIALITY PRODUCTS
 9 MOULDINGS
 10 PROMOTIONAL ITEMS
 11 POLICY

P106/ ① ?

TYPE A (Full post)
Top view

TYPE B (1 Corner post)
Top view

TYPE C (2 half posts)
Top view

Note: Sold in pairs

OPTIONS

①	Width	3" - 3 1/2" - 4"
	Height	34 1/2"
?	Type	A/B/C

P108/ ① ?

TYPE A (Full post)
Top view

TYPE B (1 Corner post)
Top view

TYPE C (2 half posts)
Top view

Note: Sold in pairs

OPTIONS

①	Width	3" - 3 1/2" - 4"
	Height	34 1/2"
?	Type	A/B/C

Speciality products

Wood posts

P109/ ① ?

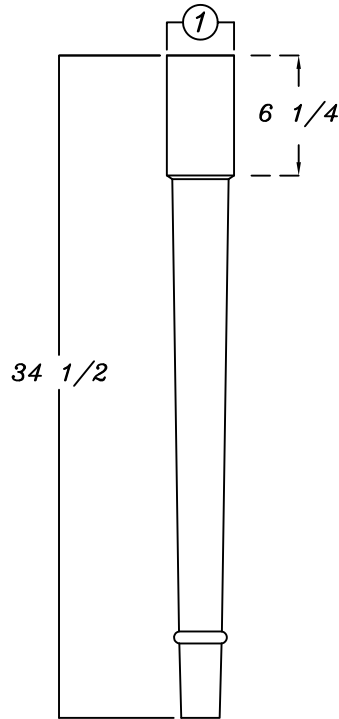

OPTIONS

①	Width	3" - 3 1/2" - 4"
	Height	34 1/2"
?	Type	A/B/C

*TYPE A (Full post)
Top view*

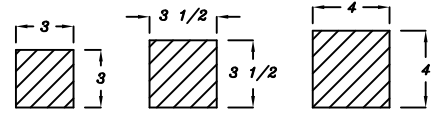

*TYPE B (1 Corner post)
Top view*

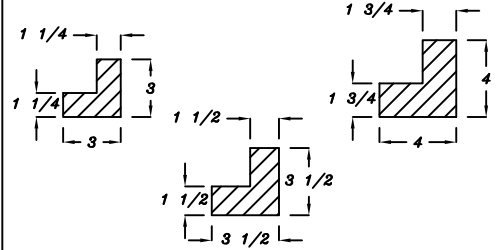

*TYPE C (2 half posts)
Top view*

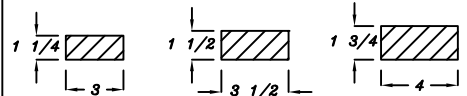

Note: Sold in pairs

P110/ ① ② ?

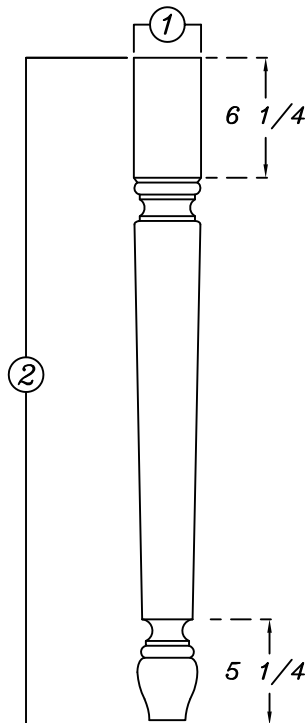

OPTIONS

①	Width	3" - 3 1/2"
②	Height	28 1/2" - 30 1/2" - 34 1/2" - 42"
?	Type	A/B/C

*TYPE A (Full post)
Top view*

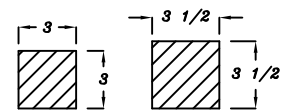

*TYPE B (1 Corner post)
Top view*

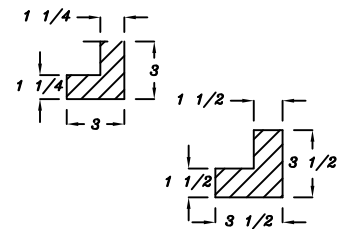

*TYPE C (2 half posts)
Top view*

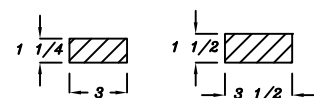

Note: Sold in pairs

Speciality products

Wood posts

- 1 PROFILES
- 2 TRADITIONAL 90
- 3 DISTINCTIVE 90
- 4 CATHEDRAL 90
- 5 APPLIED MOULDINGS
- 6 PRESTIGE 45
- 7 WAINSCOTS
- 8 SPECIALITY PRODUCTS
- 9 MOULDINGS
- 10 PROMOTIONAL ITEMS
- 11 POLICY

P111 / ① ② ?

OPTIONS

①	Width	3" - 3 1/2"
②	Height	28 1/2" - 30 1/2" - 34 1/2" - 42"
?	Type	A/B/C

TYPE A (Full post)
Top view

TYPE B (1 Corner post)
Top view

TYPE C (2 half posts)
Top view

Note: Sold in pairs

P112 / ① ② ?

OPTIONS

①	Width	3" - 3 1/2"
②	Height	28 1/2" - 30 1/2" - 34 1/2" - 42"
?	Type	A/B/C

TYPE A (Full post)
Top view

TYPE B (1 Corner post)
Top view

TYPE C (2 half posts)
Top view

Note: Sold in pairs

Speciality products

Wood posts

P113/ ① ② ?

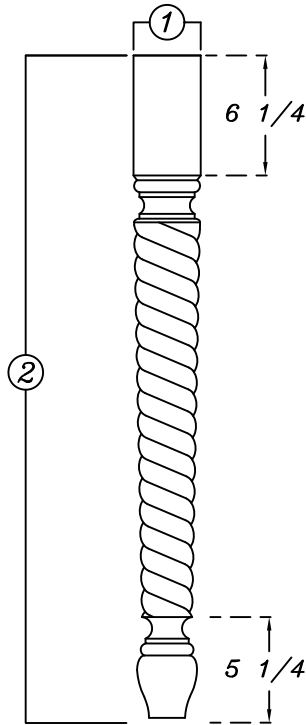

OPTIONS

①	Width	3" - 3 1/2"
②	Height	28 1/2" - 30 1/2" - 34 1/2" - 42"
?	Type	A/B/C

TYPE A (Full post)
Top view

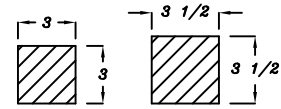

TYPE B (1 Corner post)
Top view

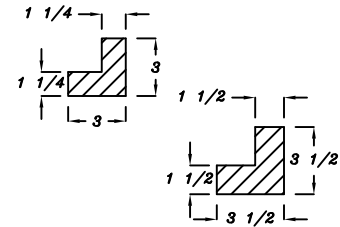

TYPE C (2 half posts)
Top view

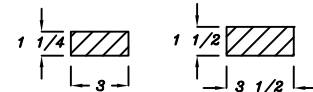

Note: Sold in pairs

P114/?

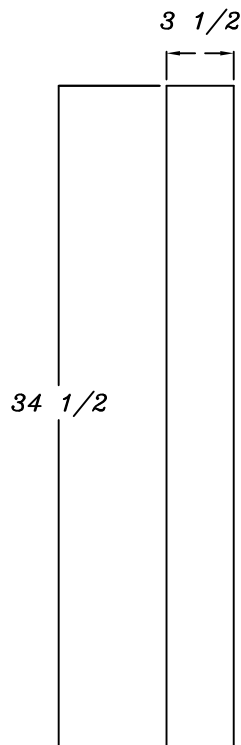

OPTIONS

①	Width	3 1/2"
②	Height	34 1/2"
?	Type	A/B/C

TYPE A (Full post)
Top view

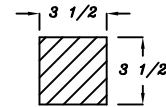

TYPE B (1 Corner post)
Top view

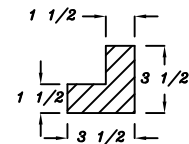

TYPE C (2 half posts)
Top view

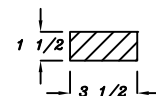

Note: Sold in pairs

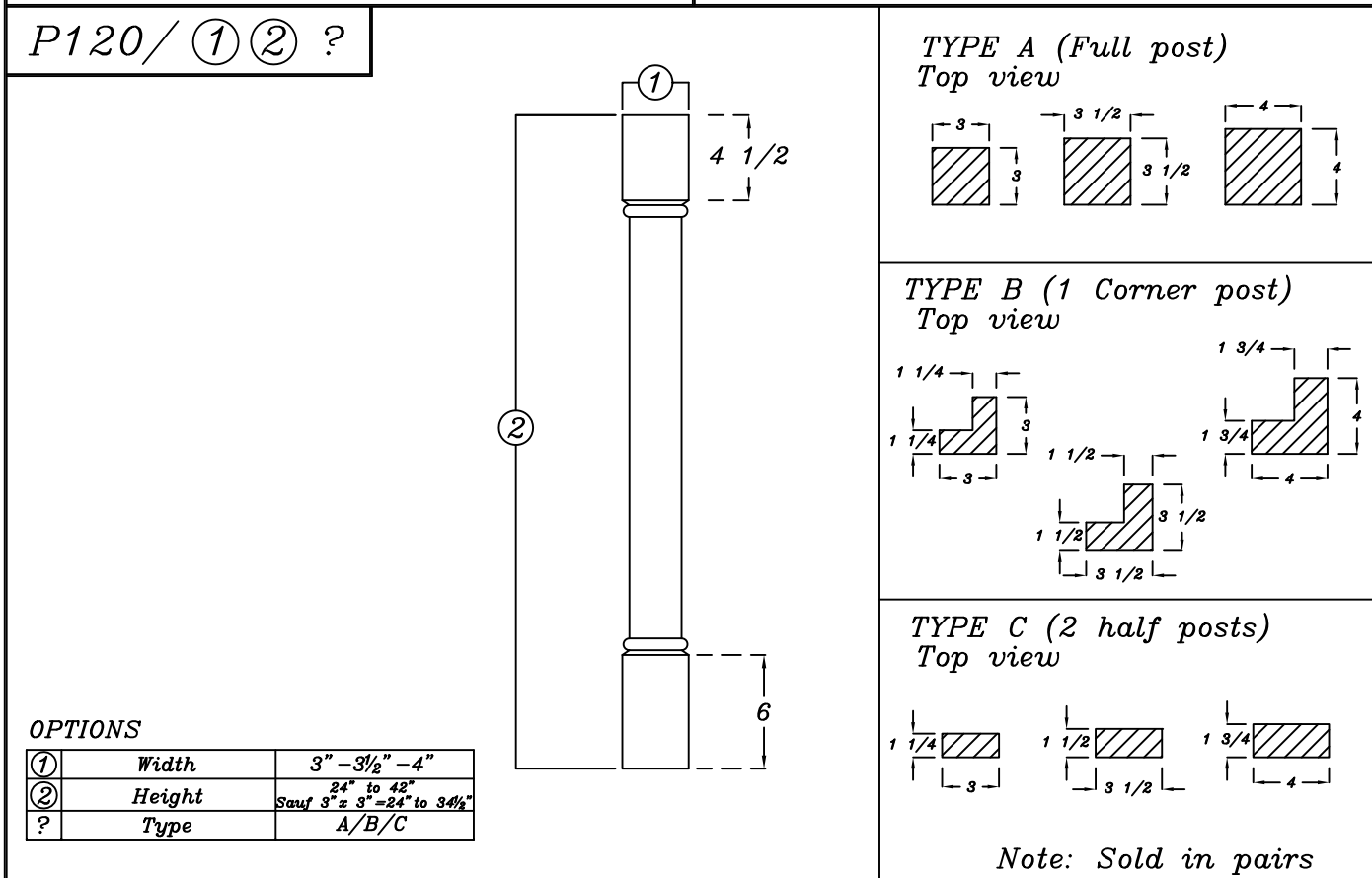
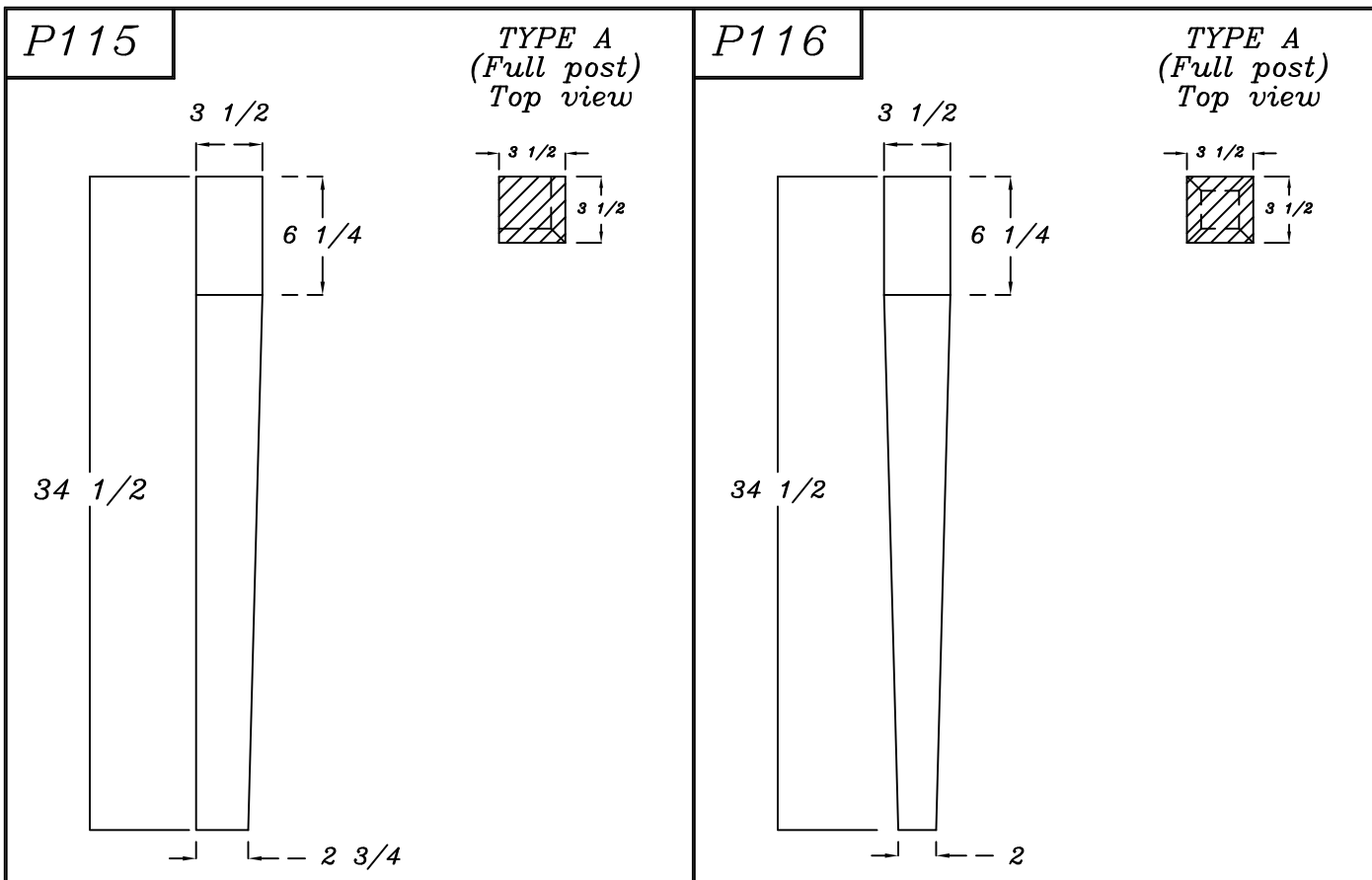

Speciality products

Wood posts

P121/ ① ② ?

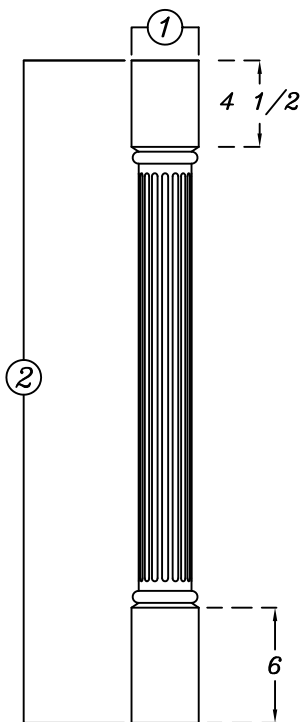

OPTIONS

①	Width	3" - 3 1/2" - 4"
②	Height	24" to 42" Sauf 3" x 3" = 24" to 34 1/2"
?	Type	A/B/C

TYPE A (Full post)
Top view

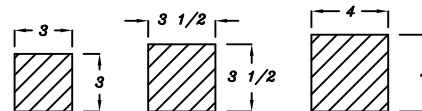

TYPE B (1 Corner post)
Top view

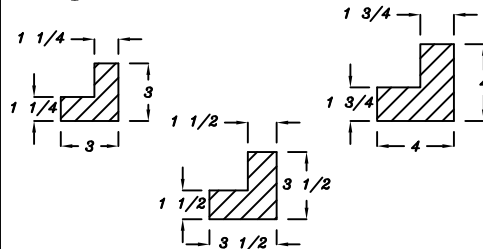

TYPE C (2 half posts)
Top view

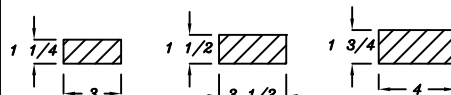

Note: Sold in pairs

P122/ ① ② ?

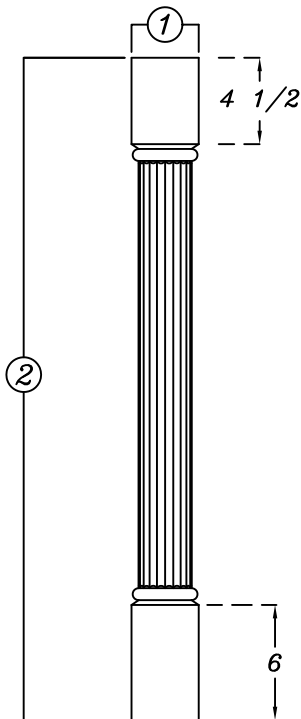

OPTIONS

①	Width	3" - 3 1/2" - 4"
②	Height	24" to 42" Sauf 3" x 3" = 24" to 34 1/2"
?	Type	A/B/C

TYPE A (Full post)
Top view

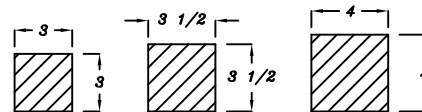

TYPE B (1 Corner post)
Top view

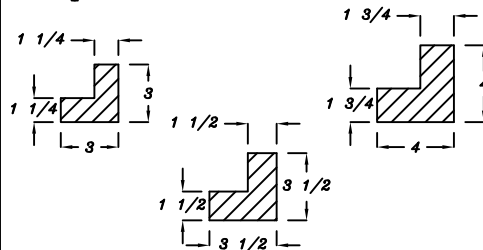

TYPE C (2 half posts)
Top view

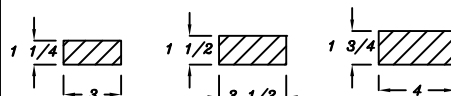

Note: Sold in pairs

Speciality products

Wood posts

- 1 PROFILES
- 2 TRADITIONAL 90
- 3 DISTINCTIVE 90
- 4 CATHEDRAL 90
- 5 APPLIED MOULDINGS
- 6 PRESTIGE 45
- 7 WAINSCOTS
- 8 SPECIALITY PRODUCTS
- 9 MOULDINGS
- 10 PROMOTIONAL ITEMS
- 11 POLICY

P123/ ① ② ?

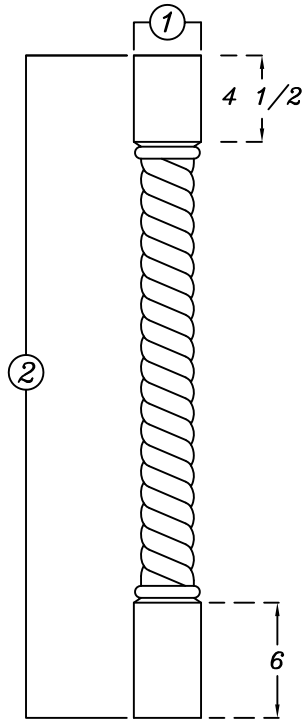

TYPE A (Full post)
Top view

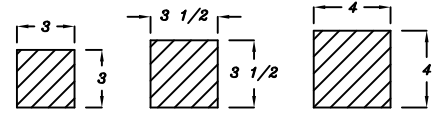

TYPE B (1 Corner post)
Top view

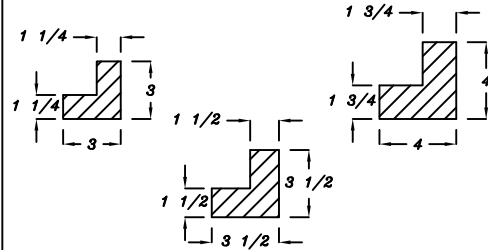

TYPE C (2 half posts)
Top view

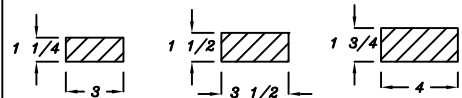

Note: Sold in pairs

OPTIONS

①	Width	3" - 3 1/2" - 4"
②	Height	24" to 42" Sauf 3" x 3" = 24" to 34 1/2"
?	Type	A/B/C

P200/ ① ② ?

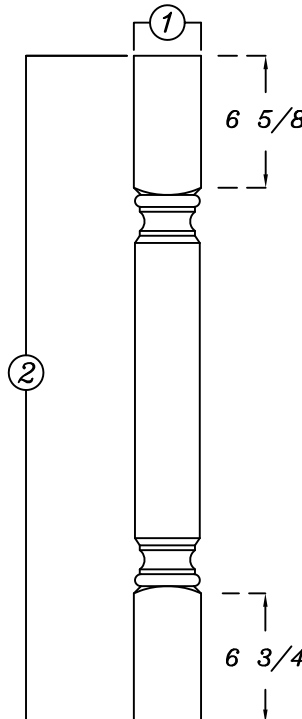

TYPE A (Full post)
Top view

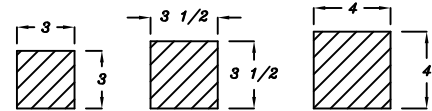

TYPE B (1 Corner post)
Top view

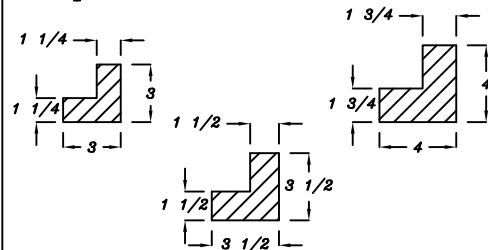

TYPE C (2 half posts)
Top view

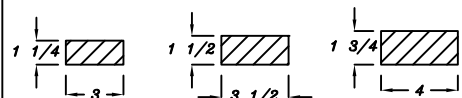

Note: Sold in pairs

OPTIONS

①	Width	3" - 3 1/2" - 4"
②	Height	28 1/2" to 42"
?	Type	A/B/C

Speciality products

Wood posts

P201/ ① ② ?

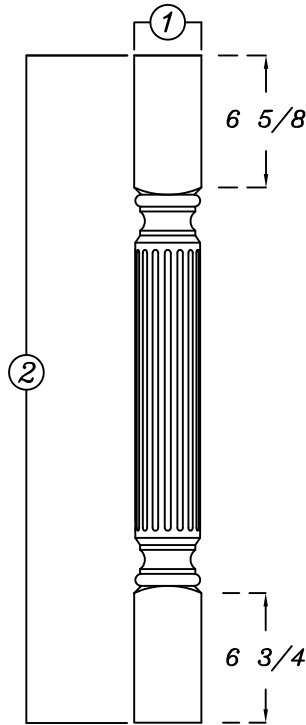

OPTIONS

①	Width	3" - 3 1/2" - 4"
②	Height	28 1/2" to 42"
?	Type	A/B/C

TYPE A (Full post)
Top view

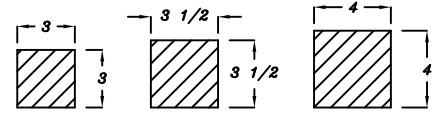

TYPE B (1 Corner post)
Top view

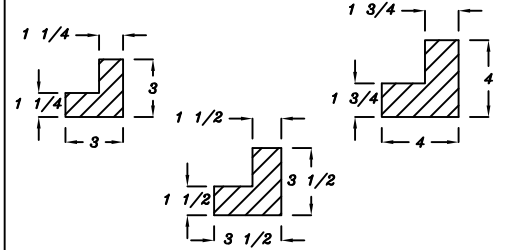

TYPE C (2 half posts)
Top view

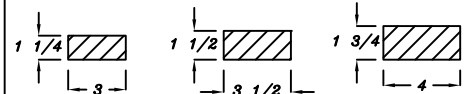

Note: Sold in pairs

P202/ ① ② ?

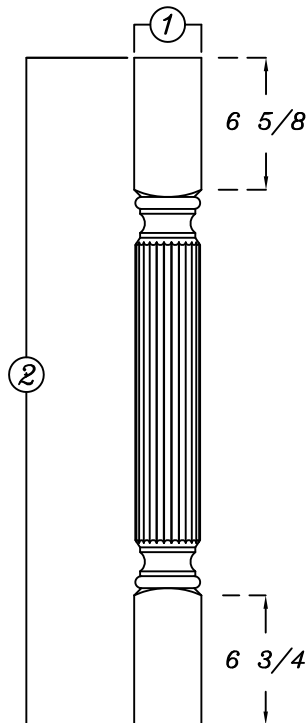

OPTIONS

①	Width	3" - 3 1/2" - 4"
②	Height	28 1/2" to 42"
?	Type	A/B/C

TYPE A (Full post)
Top view

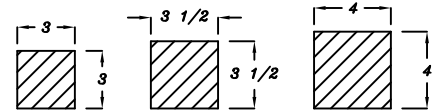

TYPE B (1 Corner post)
Top view

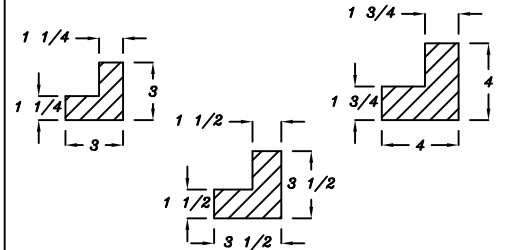

TYPE C (2 half posts)
Top view

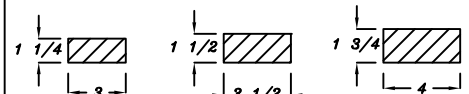

Note: Sold in pairs

Speciality products

Wood posts

- 1 PROFILES
- 2 TRADITIONAL 90
- 3 DISTINCTIVE 90
- 4 CATHEDRAL 90
- 5 APPLIED MOULDINGS
- 6 PRESTIGE 45
- 7 WAINSCOTS
- 8 SPECIALITY PRODUCTS
- 9 MOULDINGS
- 10 PROMOTIONAL ITEMS
- 11 POLICY

P203/ ① ② ?

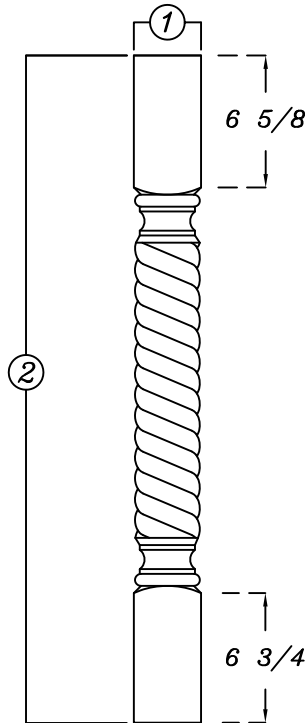

TYPE A (Full post)
Top view

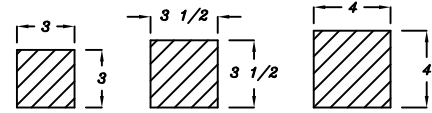

TYPE B (1 Corner post)
Top view

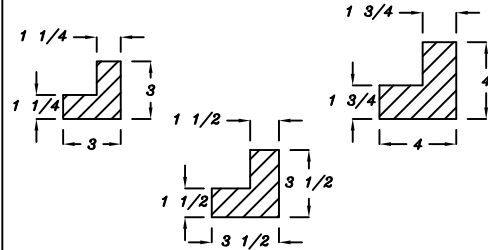

TYPE C (2 half posts)
Top view

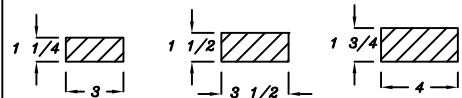

Note: Sold in pairs

OPTIONS

①	Width	3" - 3 1/2" - 4"
②	Height	28 1/2" to 42"
?	Type	A/B/C

P205/?

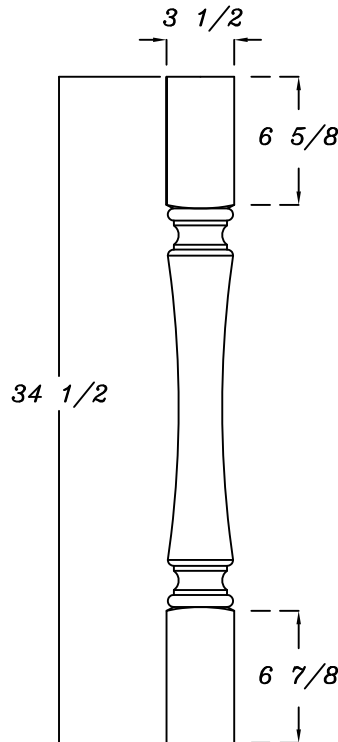

TYPE A (Full post)
Top view

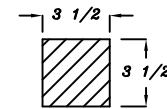

TYPE B (1 Corner post)
Top view

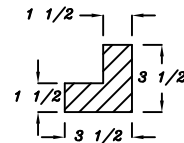

TYPE C (2 half posts)
Top view

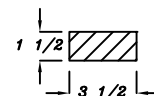

Note: Sold in pairs

OPTIONS

	Width	3 1/2"
	Height	34 1/2"
?	Type	A/B/C

Speciality products

Wood posts

P206/?

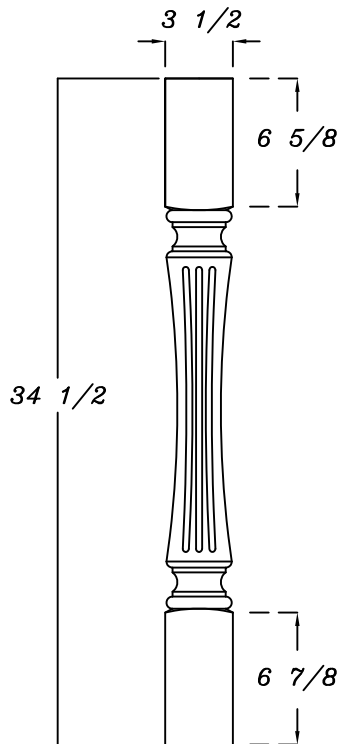

OPTIONS

Width	3 1/2"
Height	34 1/2"
? Type	A/B/C

*TYPE A (Full post)
Top view*

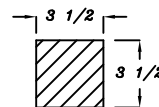

*TYPE B (1 Corner post)
Top view*

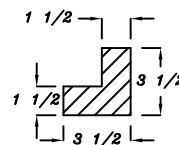

*TYPE C (2 half posts)
Top view*

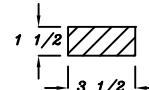

Note: Sold in pairs

P207/?

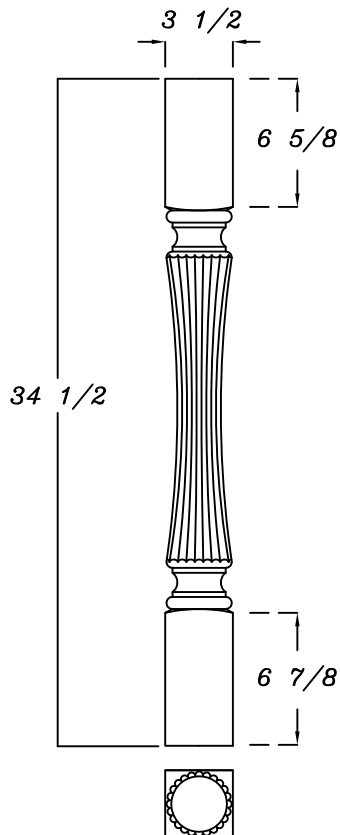

OPTIONS

Width	3 1/2"
Height	34 1/2"
? Type	A/B/C

*TYPE A (Full post)
Top view*

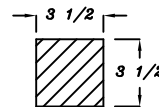

*TYPE B (1 Corner post)
Top view*

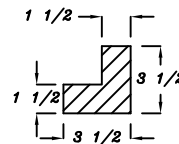

*TYPE C (2 half posts)
Top view*

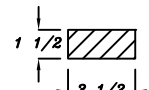

Note: Sold in pairs

Speciality products

Wood posts

P208/?

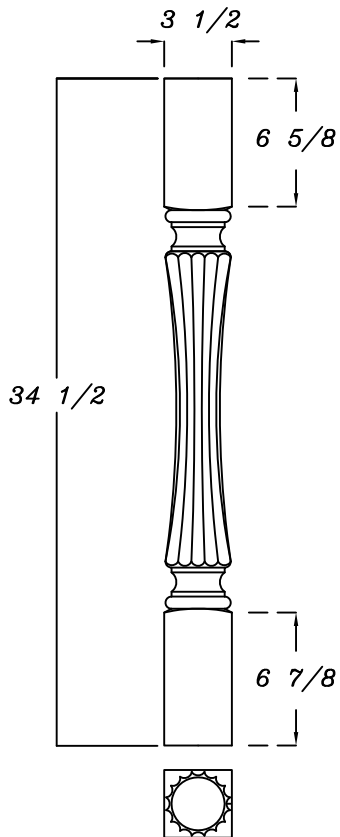

OPTIONS

Width	3 1/2"
Height	34 1/2"
? Type	A/B/C

TYPE A (Full post)
Top view

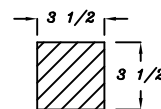

TYPE B (1 Corner post)
Top view

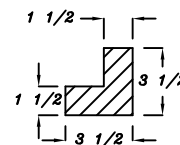

TYPE C (2 half posts)
Top view

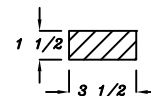

Note: Sold in pairs

P209/?

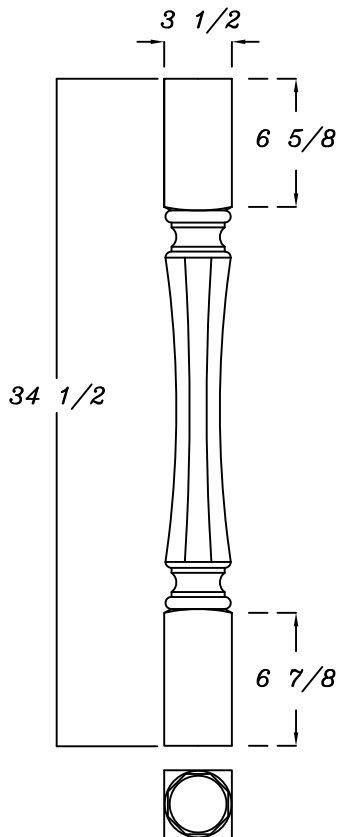

OPTIONS

Width	3 1/2"
Height	34 1/2"
? Type	A/B/C

TYPE A (Full post)
Top view

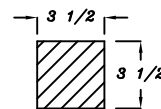

TYPE B (1 Corner post)
Top view

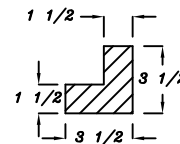

TYPE C (2 half posts)
Top view

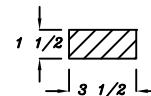

Note: Sold in pairs

- 1 PROFILES
- 2 TRADITIONAL 90
- 3 DISTINCTIVE 90
- 4 CATHEDRAL 90
- 5 APPLIED MOULDINGS
- 6 PRESTIGE 45
- 7 WAINSCOTS
- 8 SPECIALITY PRODUCTS
- 9 MOULDINGS
- 10 PROMOTIONAL ITEMS
- 11 POLICY

Speciality products

Wood posts

P210/?

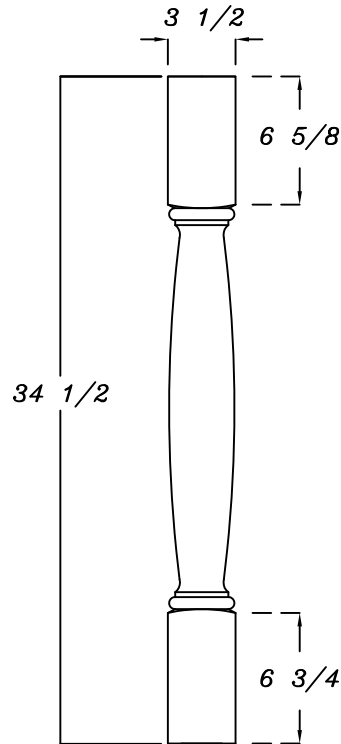

OPTIONS

①	Width	3 1/2"
②	Height	34 1/2"
?	Type	A/B/C

*TYPE A (Full post)
Top view*

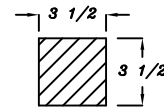

*TYPE B (1 Corner post)
Top view*

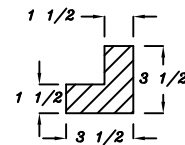

*TYPE C (2 half posts)
Top view*

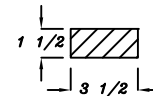

Note: Sold in pairs

P211/?

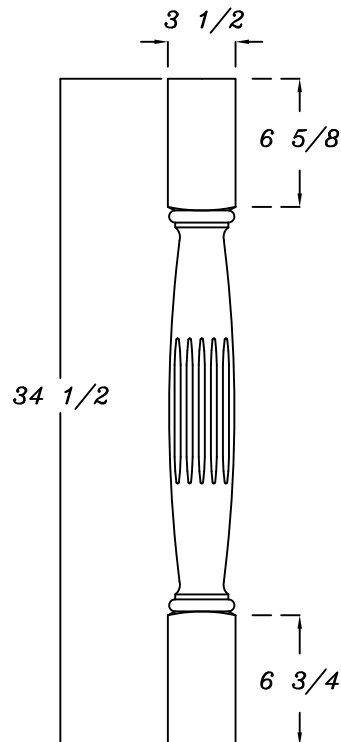

OPTIONS

	Width	3 1/2"
	Height	34 1/2"
?	Type	A/B/C

*TYPE A (Full post)
Top view*

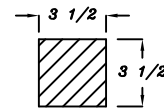

*TYPE B (1 Corner post)
Top view*

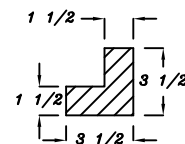

*TYPE C (2 half posts)
Top view*

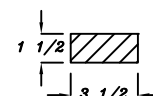

Note: Sold in pairs

Speciality products

Wood posts

- 1 PROFILES
- 2 TRADITIONAL 90
- 3 DISTINCTIVE 90
- 4 CATHEDRAL 90
- 5 APPLIED MOULDINGS
- 6 PRESTIGE 45
- 7 WAINSCOTS
- 8 SPECIALITY PRODUCTS
- 9 MOULDINGS
- 10 PROMOTIONAL ITEMS
- 11 POLICY

P300/ ① ?

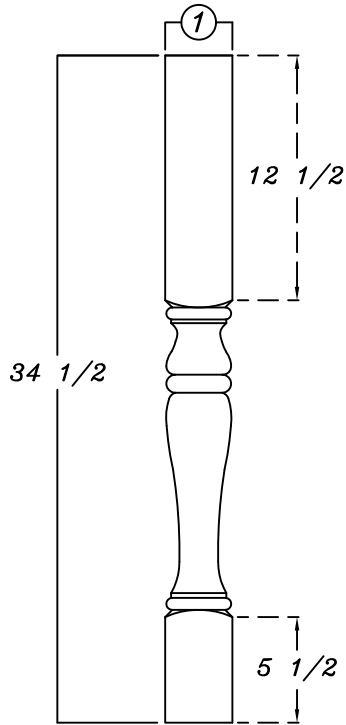

TYPE A (Full post)
Top view

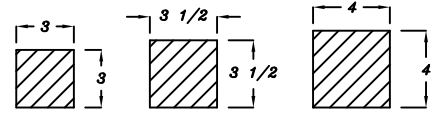

TYPE B (1 Corner post)
Top view

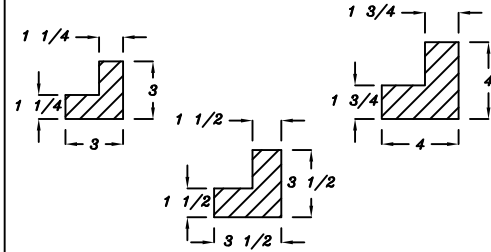

TYPE C (2 half posts)
Top view

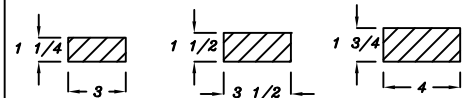

Note: Sold in pairs

OPTIONS

①	Width	3" - 3 1/2" - 4"
	Height	34 1/2"
?	Type	A/B/C

P301/?

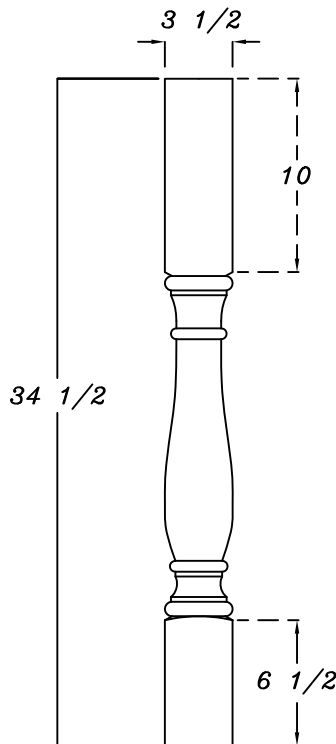

TYPE A (Full post)
Top view

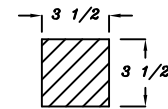

TYPE B (1 Corner post)
Top view

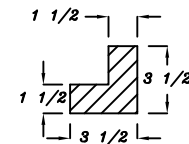

TYPE C (2 half posts)
Top view

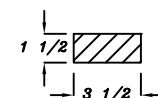

Note: Sold in pairs

OPTIONS

	Width	3 1/2"
	Height	34 1/2"
?	Type	A/B/C

Speciality products

Wood posts

<p><i>P310/?</i></p>		<p><i>TYPE A (Full post)</i> Top view</p>												
		<p><i>TYPE B (1 Corner post)</i> Top view</p>												
		<p><i>TYPE C (2 half posts)</i> Top view</p>												
<p>OPTIONS</p> <table border="1" style="width: 100%; border-collapse: collapse;"> <tr> <td style="width: 15%;">Width</td> <td style="width: 15%;">3"</td> <td style="width: 15%;"></td> <td style="width: 15%;"></td> </tr> <tr> <td>Height</td> <td>34 1/2"</td> <td></td> <td></td> </tr> <tr> <td>? Type</td> <td>A/B/C</td> <td></td> <td></td> </tr> </table>	Width	3"			Height	34 1/2"			? Type	A/B/C				<p><i>Note: Sold in pairs</i></p>
Width	3"													
Height	34 1/2"													
? Type	A/B/C													
<p><i>P311/?</i></p>		<p><i>TYPE A (Full post)</i> Top view</p>												
		<p><i>TYPE B (1 Corner post)</i> Top view</p>												
		<p><i>TYPE C (2 half posts)</i> Top view</p>												
<p>OPTIONS</p> <table border="1" style="width: 100%; border-collapse: collapse;"> <tr> <td style="width: 15%;">Width</td> <td style="width: 15%;">3 1/2"</td> <td style="width: 15%;"></td> <td style="width: 15%;"></td> </tr> <tr> <td>Height</td> <td>34 1/2"</td> <td></td> <td></td> </tr> <tr> <td>? Type</td> <td>A/B/C</td> <td></td> <td></td> </tr> </table>	Width	3 1/2"			Height	34 1/2"			? Type	A/B/C				<p><i>Note: Sold in pairs</i></p>
Width	3 1/2"													
Height	34 1/2"													
? Type	A/B/C													

Speciality products

Wood posts

- 1 PROFILES
- 2 TRADITIONAL 90
- 3 DISTINCTIVE 90
- 4 CATHEDRAL 90
- 5 APPLIED MOULDINGS
- 6 PRESTIGE 45
- 7 WAINSCOTS
- 8 SPECIALITY PRODUCTS
- 9 MOULDINGS
- 10 PROMOTIONAL ITEMS
- 11 POLICY

P312/?

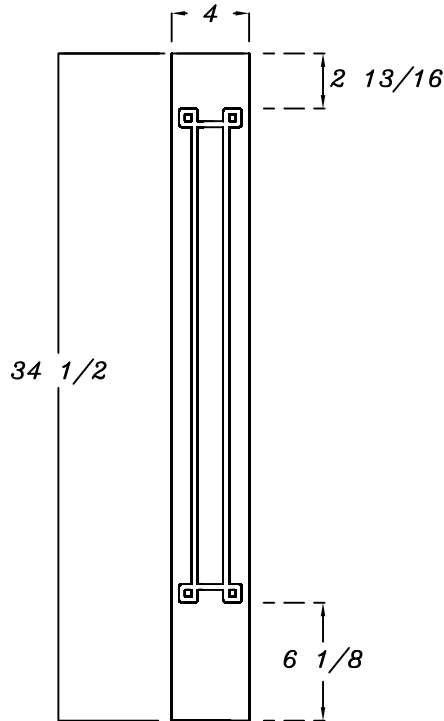

TYPE A (Full post)
Top view

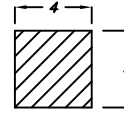

TYPE B (1 Corner post)
Top view

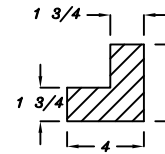

TYPE C (2 half posts)
Top view

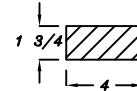

Note: Sold in pairs

OPTIONS

Width	4"
Height	34 1/2"
? Type	A/B/C

P402/?

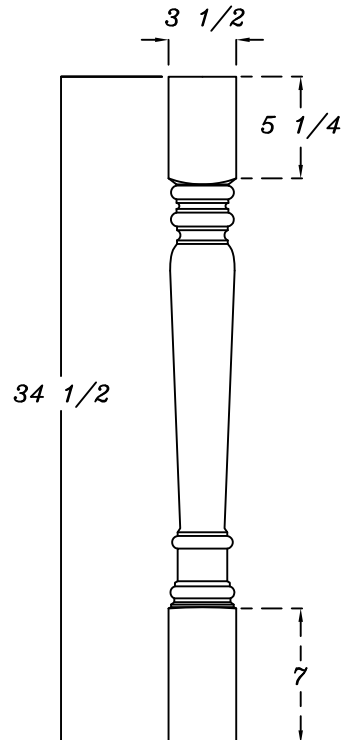

TYPE A (Full post)
Top view

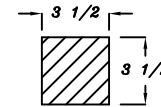

TYPE B (1 Corner post)
Top view

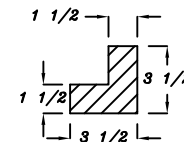

TYPE C (2 half posts)
Top view

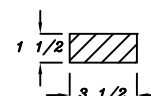

Note: Sold in pairs

OPTIONS

Width	3 1/2"
Height	34 1/2"
? Type	A/B/C

Speciality products

Wood posts

P403/?

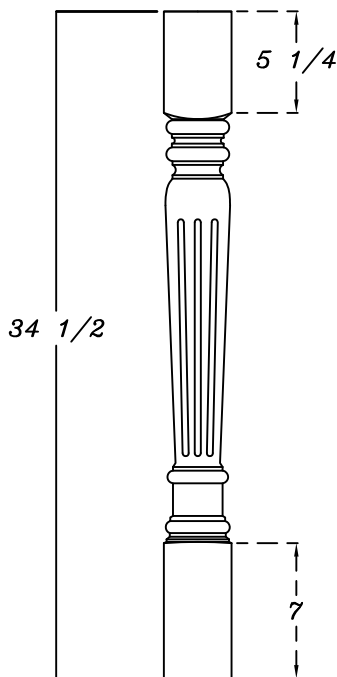

OPTIONS

Width	3 1/2"
Height	34 1/2"
? Type	A/B/C

*TYPE A (Full post)
Top view*

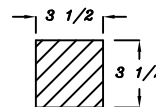

*TYPE B (1 Corner post)
Top view*

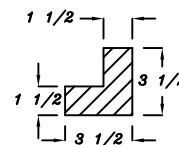

*TYPE C (2 half posts)
Top view*

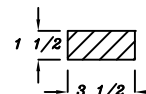

Note: Sold in pairs

P404/?

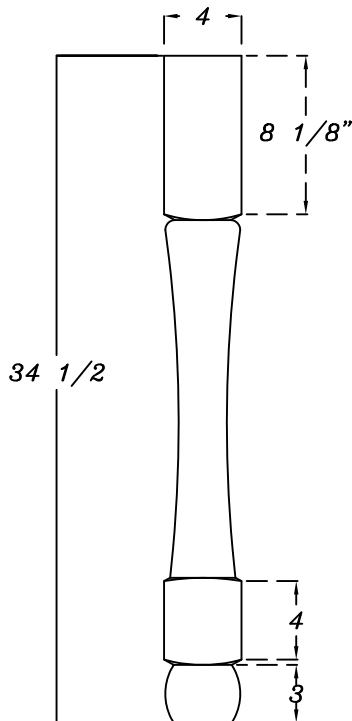

OPTIONS

Width	4"
Height	34 1/2"
? Type	A/B/C

*TYPE A (Full post)
Top view*

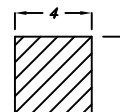

*TYPE B (1 Corner post)
Top view*

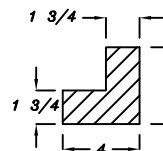

*TYPE C (2 half posts)
Top view*

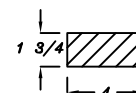

Note: Sold in pairs

Speciality products

Wood posts

- 1 PROFILES
- 2 TRADITIONAL 90
- 3 DISTINCTIVE 90
- 4 CATHEDRAL 90
- 5 APPLIED MOULDINGS
- 6 PRESTIGE 45
- 7 WAINSCOTS
- 8 SPECIALITY PRODUCTS
- 9 MOULDINGS
- 10 PROMOTIONAL ITEMS
- 11 POLICY

P405/?

OPTIONS

Width	4"
Height	34 1/2"
? Type	A/B/C

OPTIONS

① Width	2 3/4"
② Height	34 1/2"
? Type	A/B/C

OPTIONS

① Width	2 3/4"
② Height	34 1/2"
? Type	A/B/C

Speciality products

Wood posts

P407/?

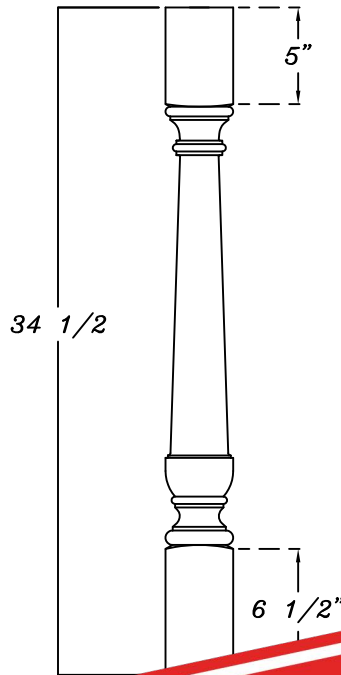

OPTIONS

Width	3 1/2"
Height	34 1/2"
? Type	A/B/C

*TYPE A (Full post)
Top view*

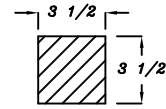

*TYPE B (1 Corner post)
Top view*

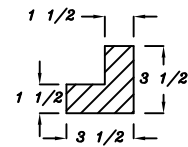

*TYPE C (2 half posts)
Top view*

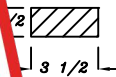

Sold in pairs

P408/?

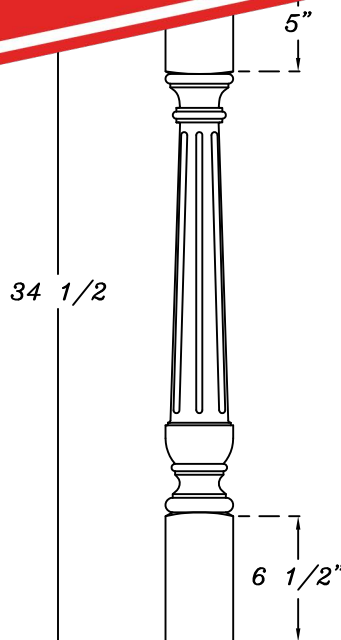

OPTIONS

Width	3 1/2"
Height	34 1/2"
? Type	A/B/C

*TYPE A (Full post)
Top view*

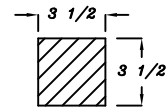

*TYPE B (1 Corner post)
Top view*

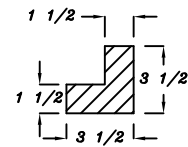

*TYPE C (2 half posts)
Top view*

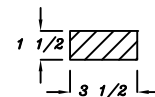

Note: Sold in pairs

DISCONTINUED

P409/?

TYPE A (Full post)
 Top view

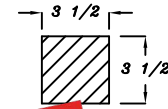
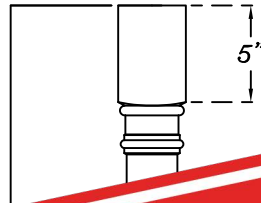

corner post)

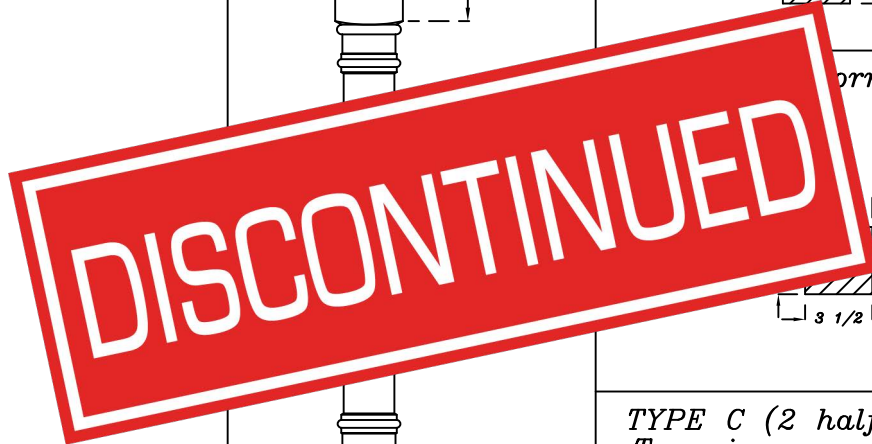
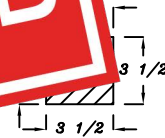

TYPE C (2 half posts)
 Top view

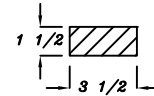
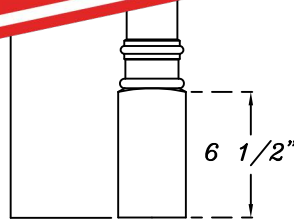

Note: Sold in pairs

OPTIONS

Width	3 1/2"
Height	3 4/2"
? Type	A/B/C

ZL100/ (2)

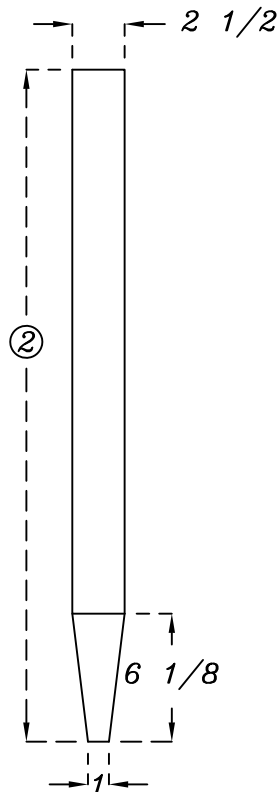

OPTIONS

Width	2 1/2"
Height	12" to 96"

Speciality products

Wood posts

ZL101/ ②

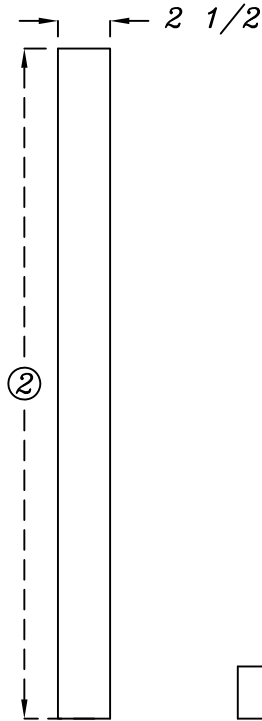

OPTIONS

	<i>Width</i>	<i>2 1/2"</i>
②	<i>Height</i>	<i>12" to 96"</i>

<p>P400/ ①</p> <p><i>Top view</i></p> <p style="text-align: center;">①</p> <p>OPTIONS</p> <table border="1" style="width: 100%; border-collapse: collapse;"> <tr> <td style="width: 10%; text-align: center;">①</td> <td style="width: 40%;">Height</td> <td style="width: 50%;">8" or 12"</td> </tr> </table>	①	Height	8" or 12"	<p>SP01/ ① ②</p> <p style="text-align: center;">P401</p> <p style="text-align: center;">①</p> <p style="text-align: center;">②</p>						
①	Height	8" or 12"								
<p>P401</p> <p><i>Top view</i></p> <p style="text-align: center;">①</p> <p>OPTIONS</p> <table border="1" style="width: 100%; border-collapse: collapse;"> <tr> <td style="width: 10%; text-align: center;">①</td> <td style="width: 40%;">Height</td> <td style="width: 50%;">8" or 12"</td> </tr> </table> <p style="text-align: center;"><i>Note: Sold in pairs</i></p>	①	Height	8" or 12"	<p style="text-align: center;">P401</p> <p style="text-align: center;">①</p> <p style="text-align: center;">②</p> <p>OPTIONS</p> <table border="1" style="width: 100%; border-collapse: collapse;"> <tr> <td style="width: 10%; text-align: center;">①</td> <td style="width: 40%;">Height</td> <td style="width: 50%;">8" or 12" *Sold in pairs*</td> </tr> <tr> <td style="width: 10%; text-align: center;">②</td> <td style="width: 40%;">Height</td> <td style="width: 50%;">12" to 96"</td> </tr> </table>	①	Height	8" or 12" *Sold in pairs*	②	Height	12" to 96"
①	Height	8" or 12"								
①	Height	8" or 12" *Sold in pairs*								
②	Height	12" to 96"								

DISCONTINUED

1	PROFILES
2	TRADITIONAL 90
3	DISTINCTIVE 90
4	CATHEDRAL 90
5	APPLIED MOULDINGS
6	PRESTIGE 45
7	WANNSCOTS
8	SPECIALITY PRODUCTS
9	MOULDINGS
10	PROMOTIONAL ITEMS
11	POLICY

Speciality products

Haft-posts

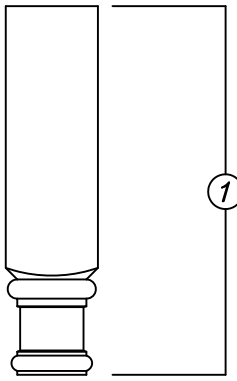
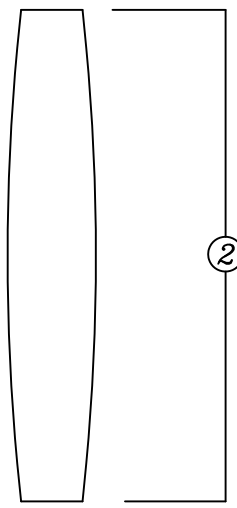
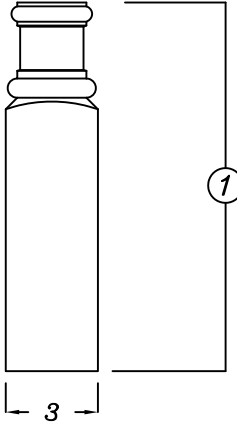
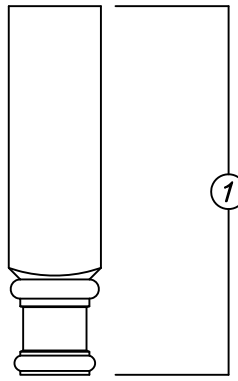
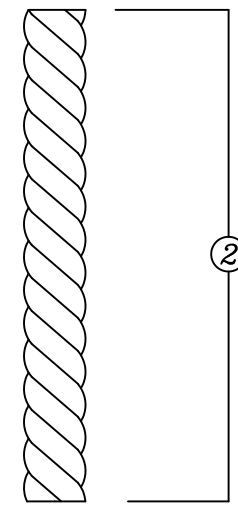
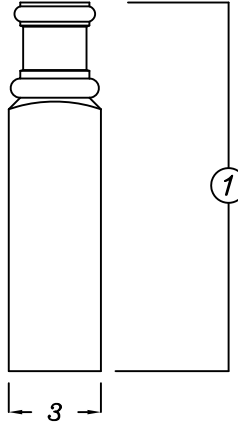
<i>SP02/</i> ① ②	<i>SP03/</i> ① ②												
<div style="display: flex; justify-content: space-between; align-items: center;"> <div style="width: 40%;"><i>P401</i></div>  </div> <div style="display: flex; justify-content: space-between; align-items: center; margin-top: 20px;"> <div style="width: 40%;"><i>BN2C</i></div>  </div> <div style="display: flex; justify-content: space-between; align-items: center; margin-top: 20px;"> <div style="width: 40%;"><i>P401</i></div>  </div>	<div style="display: flex; justify-content: space-between; align-items: center;"> <div style="width: 40%;"><i>P401</i></div>  </div> <div style="display: flex; justify-content: space-between; align-items: center; margin-top: 20px;"> <div style="width: 40%;"><i>RP2C</i></div>  </div> <div style="display: flex; justify-content: space-between; align-items: center; margin-top: 20px;"> <div style="width: 40%;"><i>P401</i></div>  </div>												
<p>OPTIONS</p> <table border="1" style="width: 100%; border-collapse: collapse;"> <tr> <td style="width: 5%; text-align: center;">①</td> <td style="width: 15%;">Height</td> <td style="width: 80%;">8" or 12" *Sold in pairs*</td> </tr> <tr> <td style="text-align: center;">②</td> <td>Height</td> <td>12" to 42" *Sold in pairs*</td> </tr> </table>	①	Height	8" or 12" *Sold in pairs*	②	Height	12" to 42" *Sold in pairs*	<p>OPTIONS</p> <table border="1" style="width: 100%; border-collapse: collapse;"> <tr> <td style="width: 5%; text-align: center;">①</td> <td style="width: 15%;">Height</td> <td style="width: 80%;">8" or 12" *Sold in pairs*</td> </tr> <tr> <td style="text-align: center;">②</td> <td>Height</td> <td>12" to 42" *Sold in pairs*</td> </tr> </table>	①	Height	8" or 12" *Sold in pairs*	②	Height	12" to 42" *Sold in pairs*
①	Height	8" or 12" *Sold in pairs*											
②	Height	12" to 42" *Sold in pairs*											
①	Height	8" or 12" *Sold in pairs*											
②	Height	12" to 42" *Sold in pairs*											

Speciality products

Haft-posts

SP04/ ① ②

P401

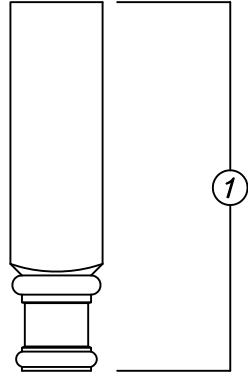

RD2C

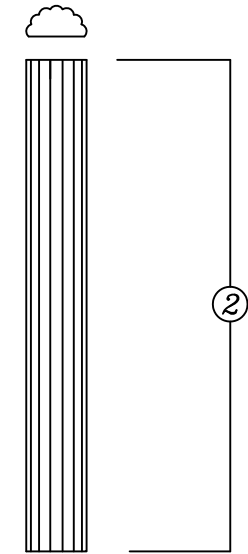

P401

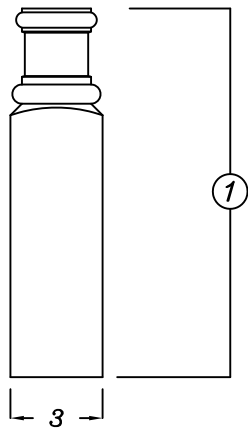

OPTIONS

①	Height	8" or 12" *Sold in pairs*
②	Height	12" to 42" *Sold in pairs*

SP05/ ① ②

P401

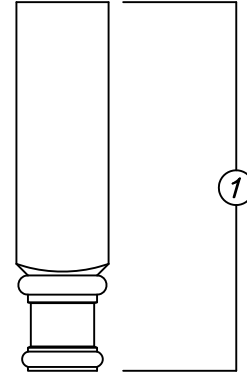

FT2C

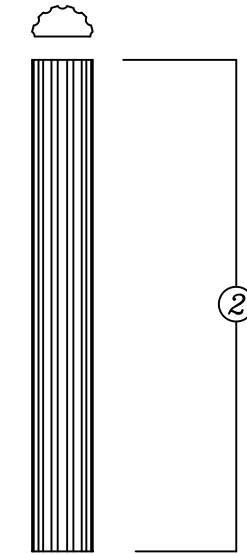

P401

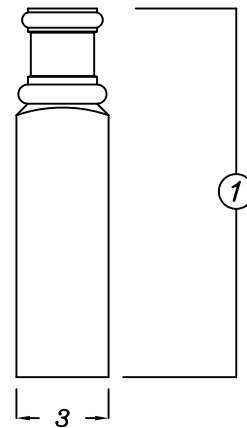

OPTIONS

①	Height	8" or 12" *Sold in pairs*
②	Height	12" to 42" *Sold in pairs*

1	PROFILES
2	TRADITIONAL 90
3	DISTINCTIVE 90
4	CATHEDRAL 90
5	APPLIED MOULDINGS
6	PRESTIGE 45
7	WAINSCOTS
8	SPECIALTY PRODUCTS
9	MOULDINGS
10	PROMOTIONAL ITEMS
11	POLICY

Speciality products

Haft-posts

SP08/ ① ② ③ ④

Side view

P401

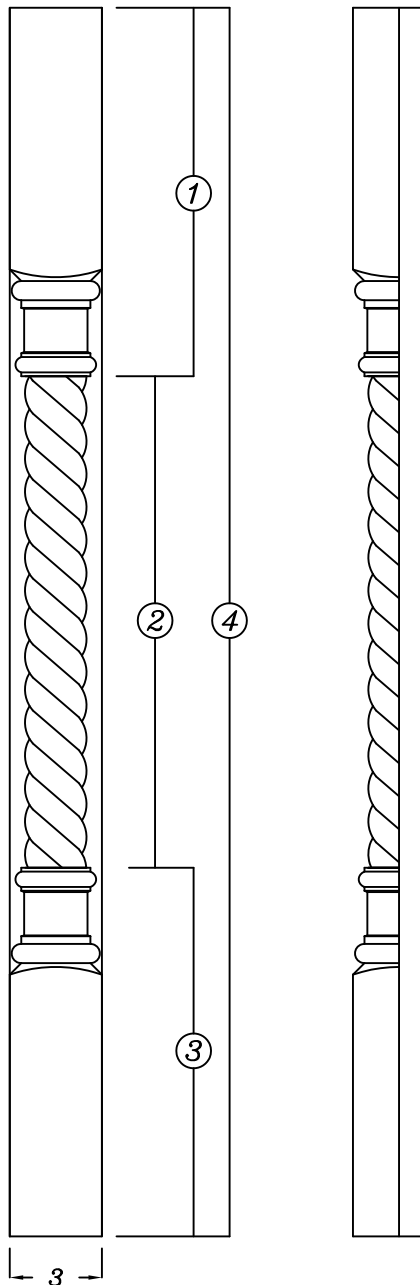

RP2C

P401

OPTIONS

①	Height	8" or 12" *Sold in pairs*
②	Height	12" to 42" *Sold in pairs*
③	Height	8" or 12" *Sold in pairs*
④	Height	28" to 66"

SP09/ ① ② ③ ④

Side view

P401

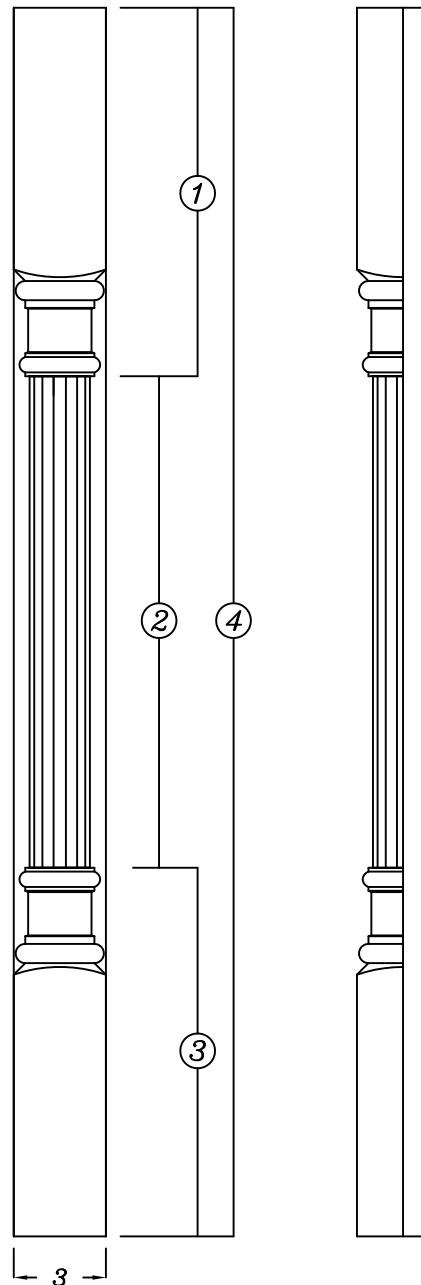

RD2C

P401

OPTIONS

①	Height	8" or 12" *Sold in pairs*
②	Height	12" to 42" *Sold in pairs*
③	Height	8" or 12" *Sold in pairs*
④	Height	28" to 66"

SP10/ ① ② ③ ④

SP11/ ①

Side view

P401

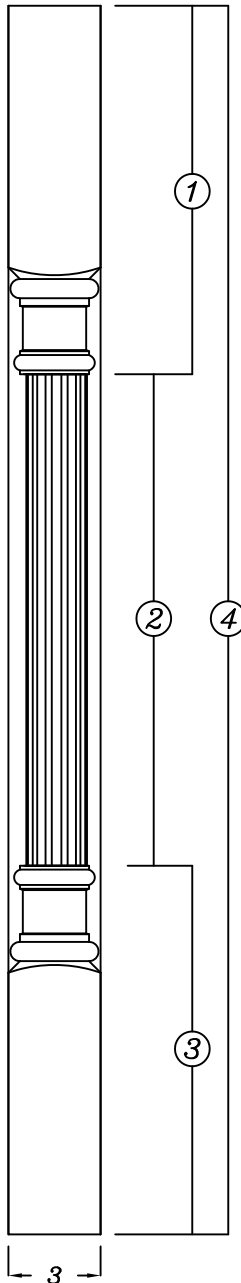

FT2C

P401

OPTIONS

①	Height	8" or 12" *Sold in pairs*
②	Height	12" to 42" *Sold in pairs*
③	Height	8" or 12" *Sold in pairs*
④	Height	28" to 66"

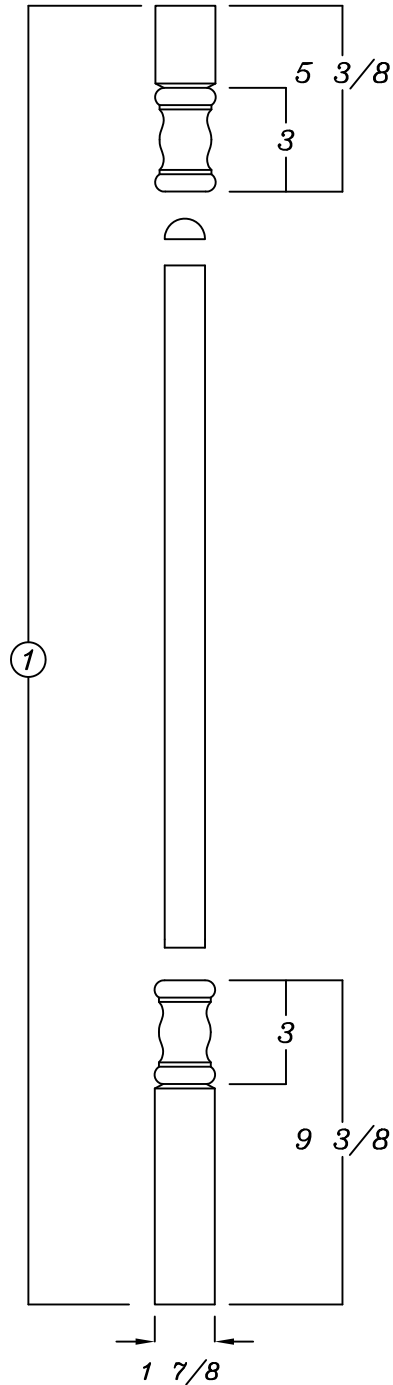

OPTIONS

①	Height	24" to 102" *Sold in pairs*
Made from 3 different pieces		

Speciality products

Haft-posts

SP12/ ①

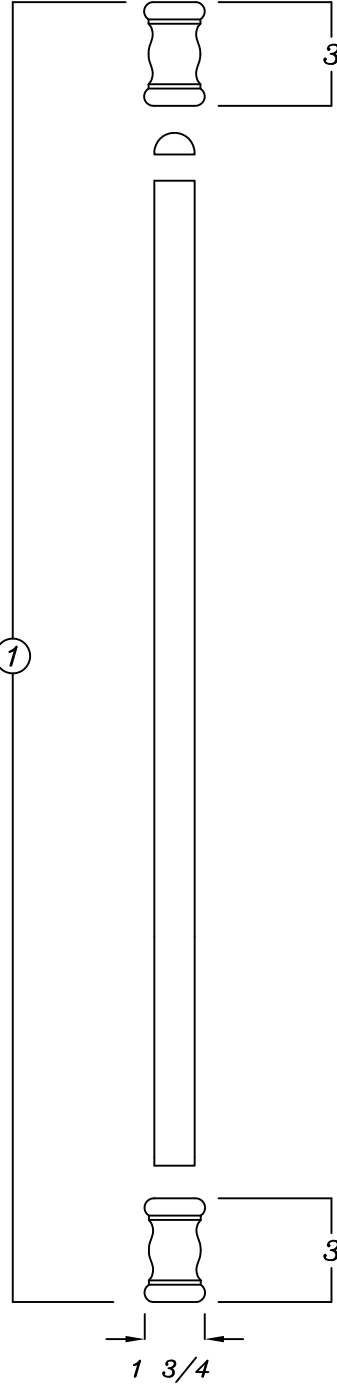

OPTIONS

①	Height	24" to 102" *Sold in pairs*
Made from 3 different pieces		

BF100

Front view *Top view*

4 1/2
3 3/8

Also available: 2 7/8" x 4 1/2"
3 7/8" x 4 1/2"

BF101

Front view *Top view*

4 1/2
3 3/8

Also available: 2 7/8" x 4 1/2"
3 7/8" x 4 1/2"

BF102

Front view *Top view*

4 1/2
4 3/4

BF103

Front view *Top view*

4 1/2
3 1/2
3 1/2

BF104

Front view *Top view*

4 1/2
2 3/4
3 1/2
3 1/2
2 3/4

BF105

Front view *Top view*

4 1/2
2
3 1/2
3 1/2
2

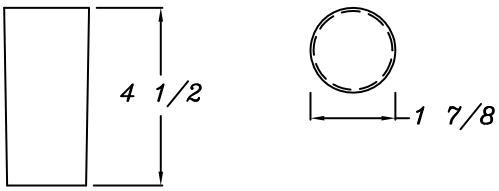
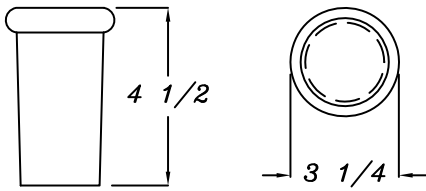
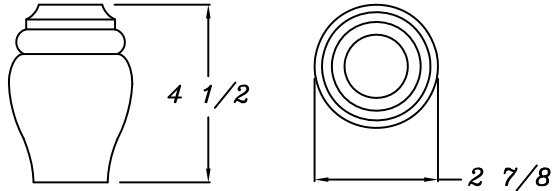
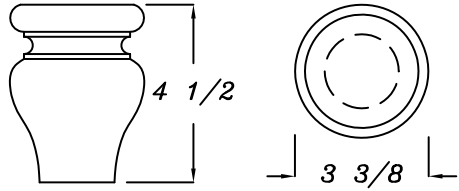
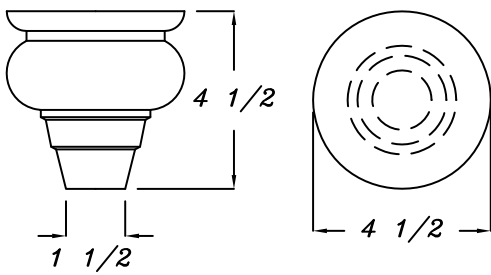
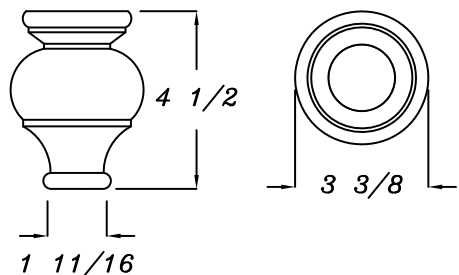
<p>BF108</p> <p><i>Front view</i> <i>Top view</i></p>  <p>Also available: 2 7/8" x 4 1/2" 3 7/8" x 4 1/2"</p>	<p>BF109</p> <p><i>Front view</i> <i>Top view</i></p>  <p>Also available: 2 1/4" x 4 1/2" 2 3/4" x 4 1/2" 3 3/4" x 4 1/2"</p>
<p>BF110</p> <p><i>Front view</i> <i>Top view</i></p>  <p>Also available: 3 3/8" x 4 1/2" 3 7/8" x 4 1/2"</p>	<p>BF112</p> <p><i>Front view</i> <i>Top view</i></p> 
<p>BF115</p> <p><i>Front view</i> <i>Top view</i></p> 	<p>BF116</p> <p><i>Front view</i> <i>Top view</i></p> 

BF118

Front view

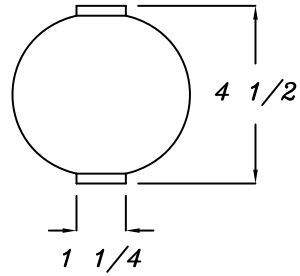

Top view

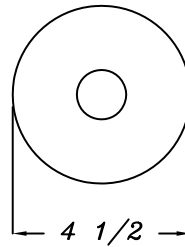

Don't hesitate to send us any other specifications or new model for Bun feet, half-posts and wood posts so we can make you a quote.

Speciality products

Range hoods

WRHF ①

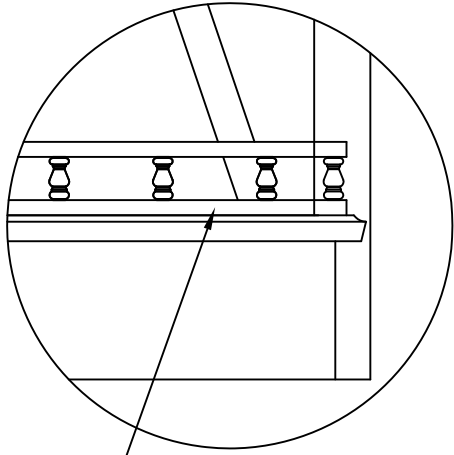

OPTIONAL FENCE

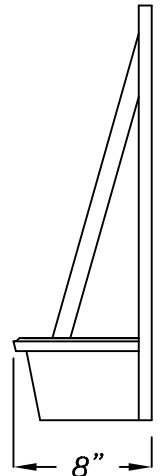
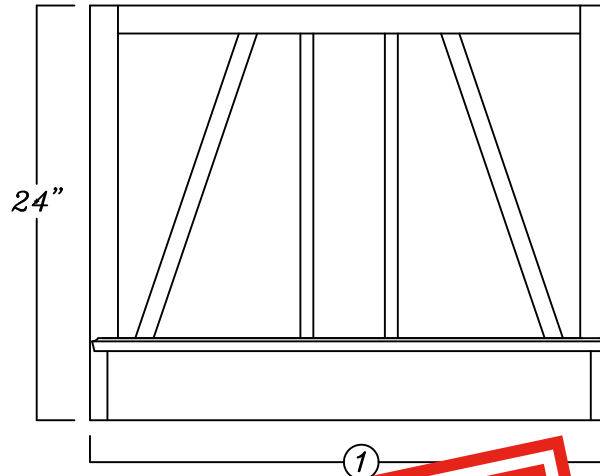

OPTIONS

① Width



W5RH ①

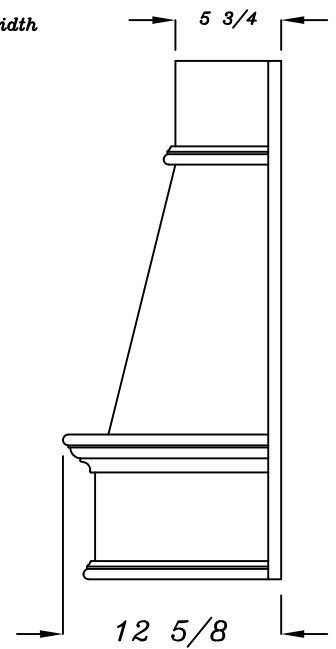
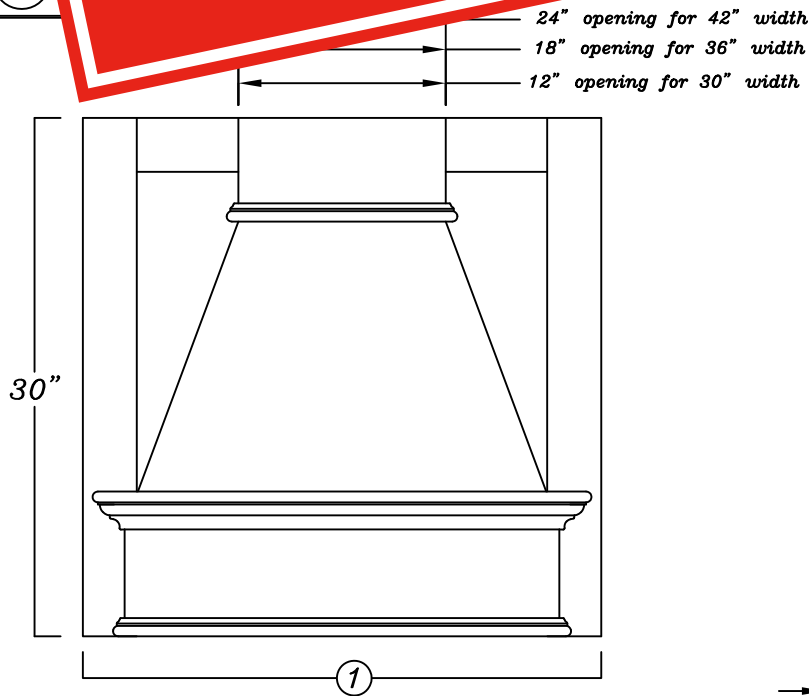

OPTIONS

① Width 30", 36", 42"

1	PROFILES
2	TRADITIONAL 90
3	DISTINCTIVE 90
4	CATHEDRAL 90
5	APPLIED MOULDINGS
6	PRESTIGE 45
7	WAINSCOTS
8	SPECIALITY PRODUCTS
9	MOULDINGS
10	PROMOTIONAL ITEMS
11	POLICY

WKAT ① ②

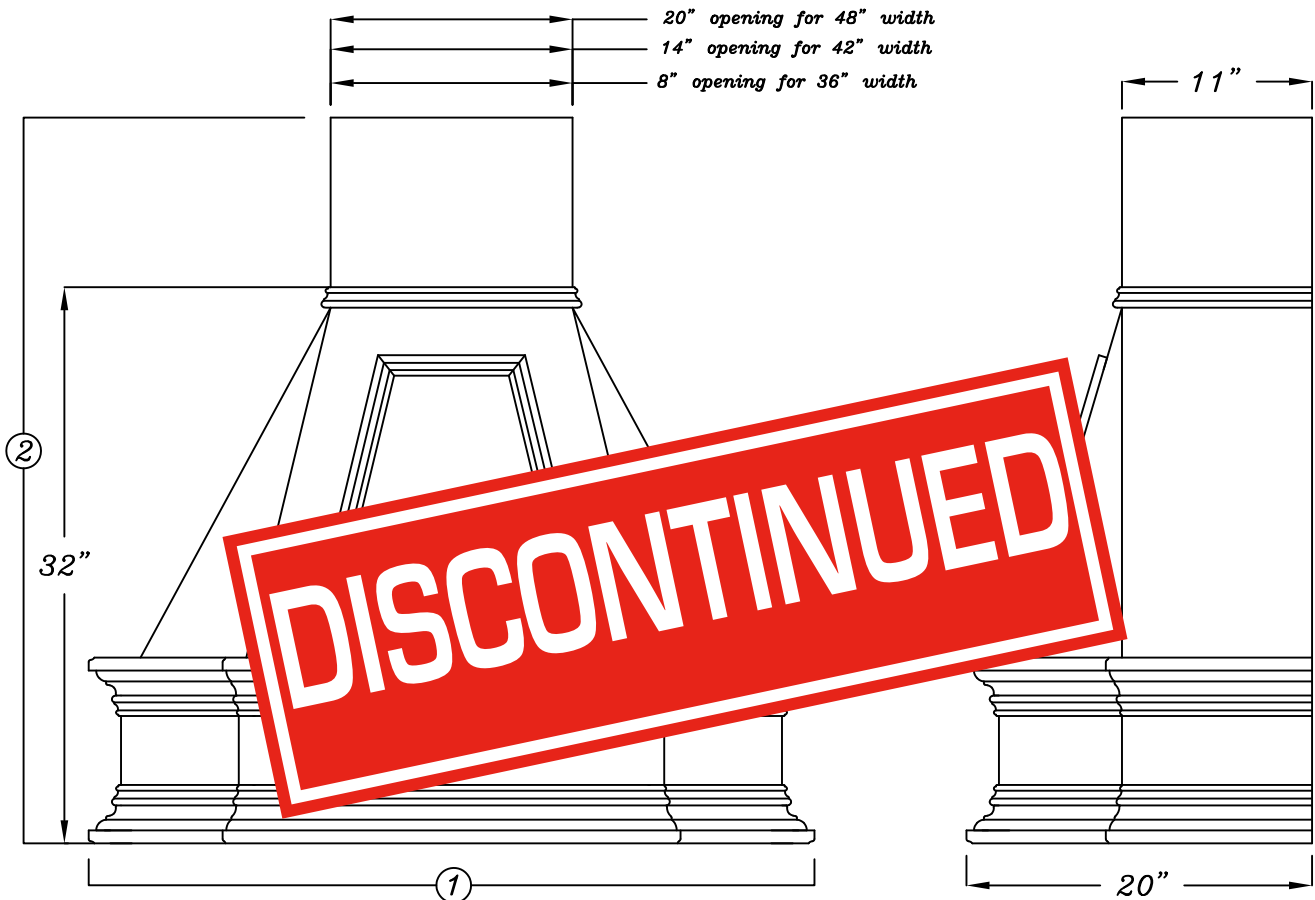

OPTIONS

①	Width	36", 42", 48"
②	Height	32" to 42"

WRH3 ① ②

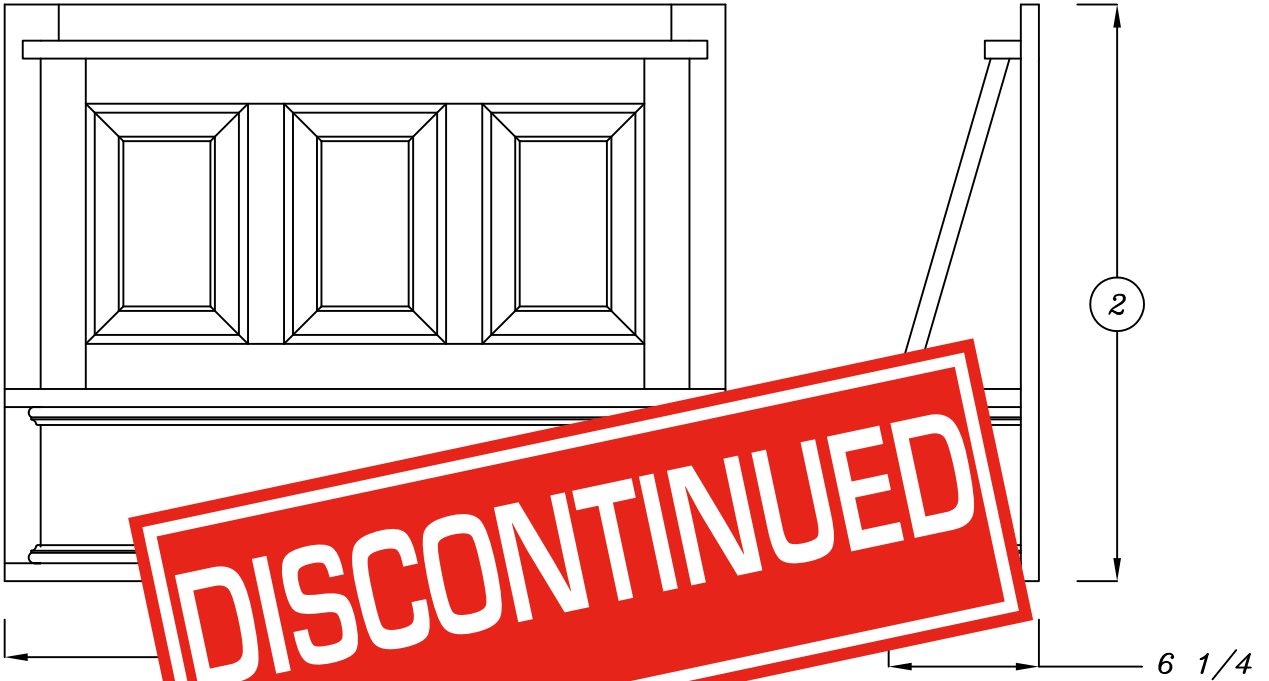

OPTIONS

①	Width
②	Height

Don't hesitate to send us any other specifications or new model so we can make you a quote.

Speciality products

Wine rack

- 1 PROFILES
- 2 TRADITIONAL 90
- 3 DISTINCTIVE 90
- 4 CATHEDRAL 90
- 5 APPLIED MOUNDINGS
- 6 PRESTIGE 45
- 7 WAINSCOTS
- 8 SPECIALTY PRODUCTS
- 9 MOUNDINGS
- 10 PROMOTIONAL ITEMS
- 11 POLICY

WRK01/?

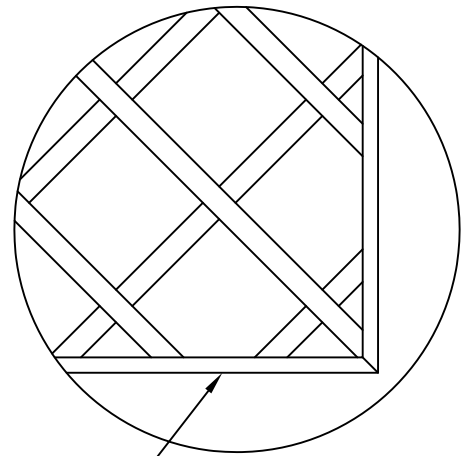
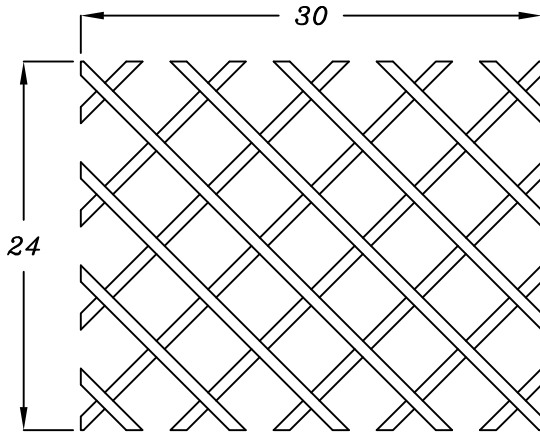

Border mouldings

Sold in pairs

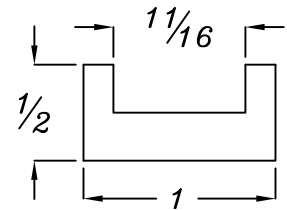

OPTIONS

? Required border moulding quantity (8 feet)

WRK02/?

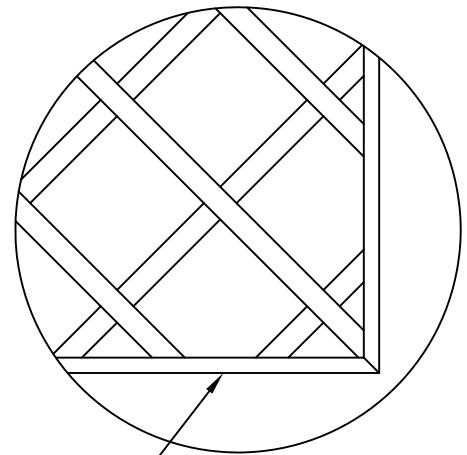
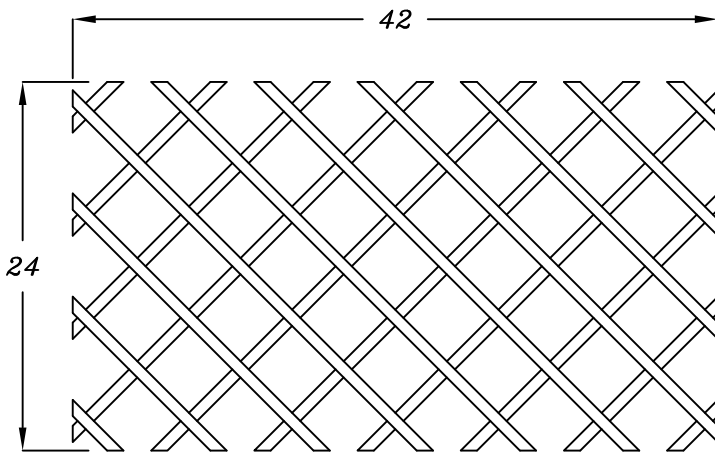

Border mouldings

Sold in pairs

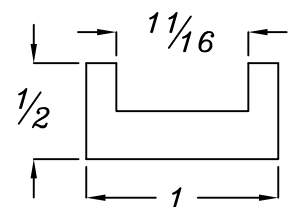

OPTIONS

? Required border moulding quantity (8 feet)

WRK03

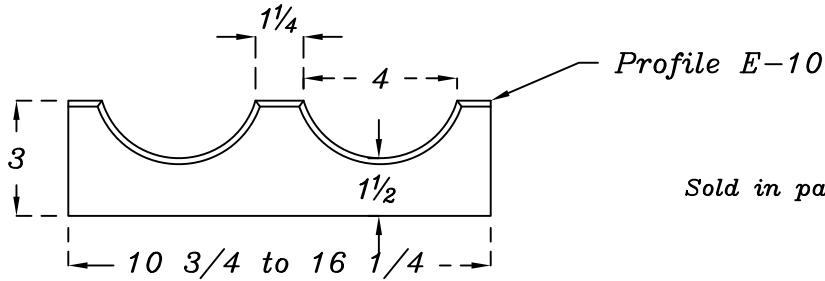

Sold in pairs

WRK04

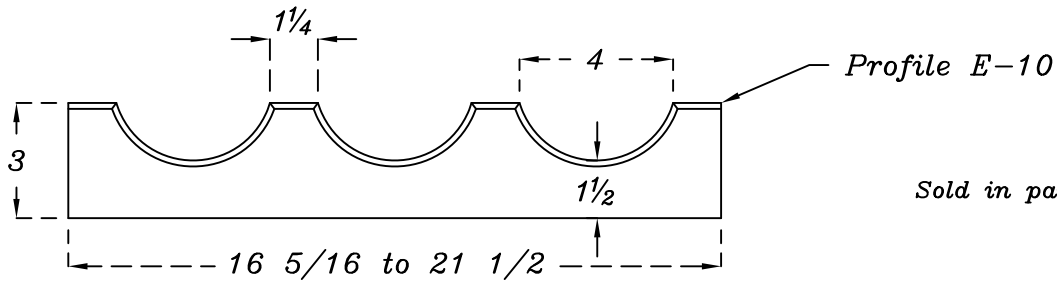

Sold in pairs

WRK05

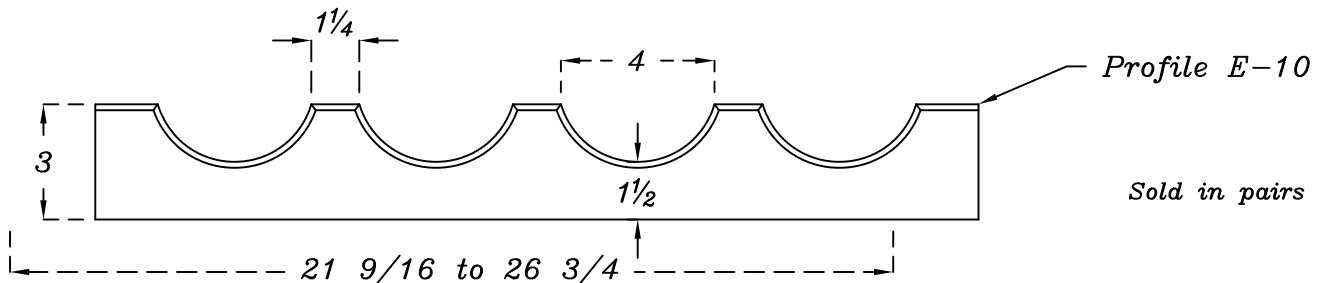

Sold in pairs

Speciality products

Wine rack

- 1 PROFILES
- 2 TRADITIONAL 90
- 3 DISTINCTIVE 90
- 4 CATHEDRAL 90
- 5 APPLIED MOULDINGS
- 6 PRESTIGE 45
- 7 WAINSCOTS
- 8 SPECIALITY PRODUCTS
- 9 MOULDINGS
- 10 PROMOTIONAL ITEMS
- 11 POLICY

WRK06

Sold in pairs

WRK07

Sold in pairs

WRK08 / ① ② ? / ...

Height ②	Number of holes
11 1/4" to 16 5/8"	2
16 11/16" to 22 1/16"	3
22 1/8" to 27 1/2"	4
27 9/16" to 32 15/16"	5
33" to 38 3/8"	6
38 7/16" to 43 7/8"	7

OPTIONS

①	Width	MINIMUM=5 3/4"
②	Height	MINIMUM=11 1/4"
?	Edge profiles	E-01 à E-58
...	Side(s) to be profiled	L=Left/R=Right/T=Top/B=Bottom

Sold separtly

WRK09

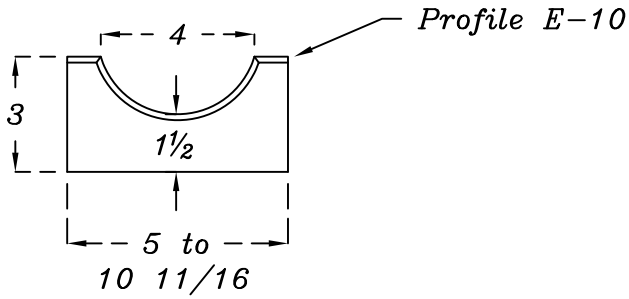

Sold in pairs

Speciality products

Stemware rack

GRK01 / ① ②

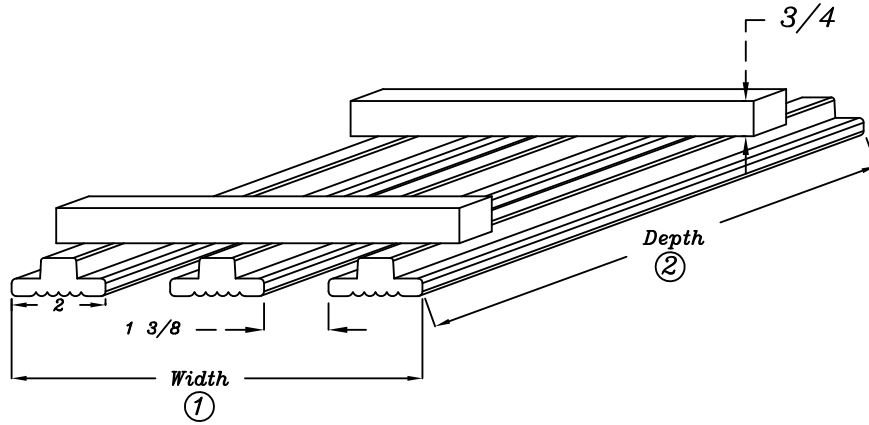

OPTIONS

①	Width	MINIMUM=5 1/4"
②	Depth	MINIMUM=6"

GRK02 / ① ②

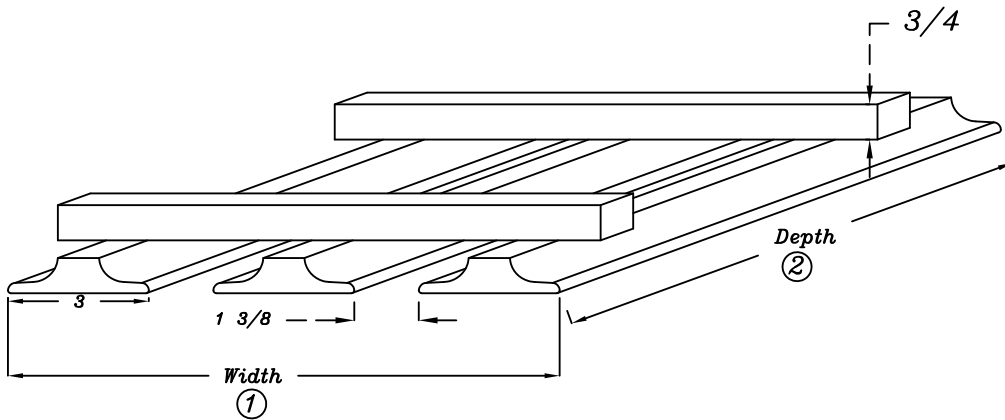

OPTIONS

①	Width	MINIMUM=5 1/4"
②	Depth	MINIMUM=6"

- 1 PROFILES
- 2 TRADITIONAL 90
- 3 DISTINCTIVE 90
- 4 CATHEDRAL 90
- 5 APPLIED MOULDINGS
- 6 PRESTIGE 45
- 7 WAINSCOTS
- 8 SPECIALITY PRODUCTS
- 9 MOULDINGS
- 10 PROMOTIONAL ITEMS
- 11 POLICY

Speciality products

Dovetail drawers

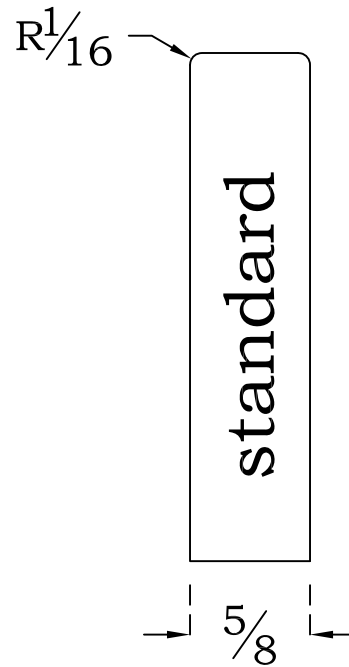
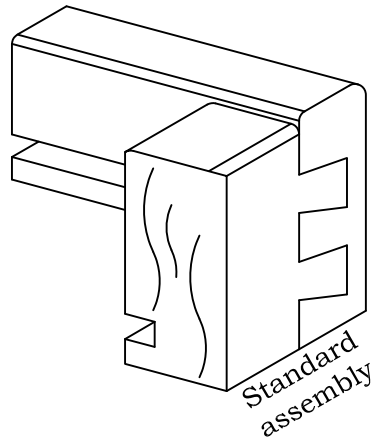

Minimum drawer size

5 $\frac{1}{2}$ " wide x 6 $\frac{1}{16}$ " deep

Maximum Width 43"
Maximum Depth 32"

Assembled with or without
finish

Charter of Dovetail heights

2 $\frac{1}{16}$ " to 2 $\frac{3}{8}$ "

3 $\frac{1}{16}$ " to 3 $\frac{3}{8}$ "

4 $\frac{1}{32}$ " to 4 $\frac{3}{8}$ "

5 $\frac{1}{16}$ " to 5 $\frac{3}{8}$ "

6" to 6 $\frac{5}{16}$ "

7" to 7 $\frac{5}{16}$ "

8" to 8 $\frac{5}{16}$ "

9" to 9 $\frac{5}{16}$ "

10" to 10 $\frac{5}{16}$ "

11" to 11 $\frac{5}{16}$ "

12" to 12 $\frac{5}{16}$ "

13" to 13 $\frac{5}{16}$ "

14" to 14 $\frac{3}{16}$ "

Bottom available $\frac{1}{4}$ " and $\frac{1}{2}$ "

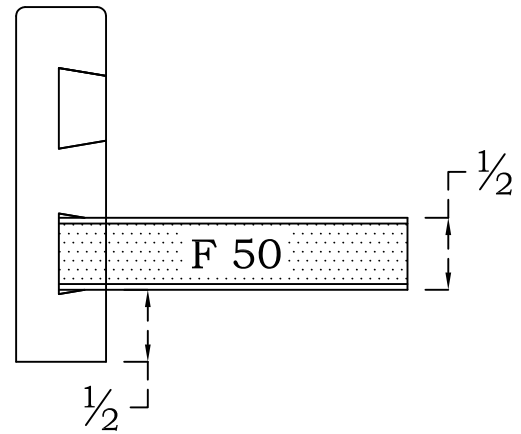
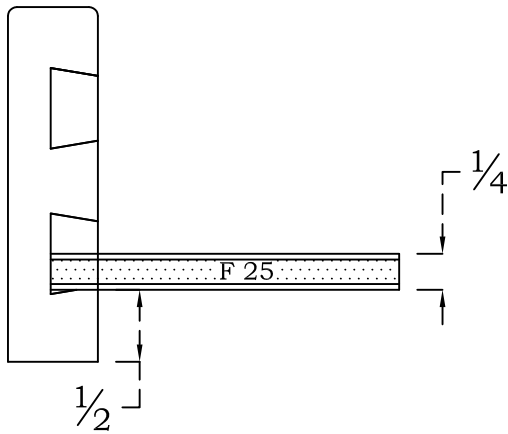

Decorative hand pull

SC0

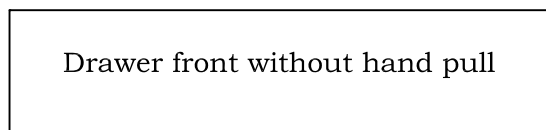

SC2

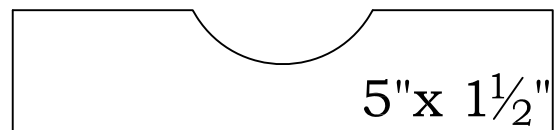

SC1

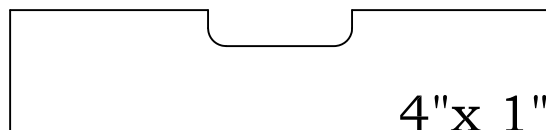

SC3

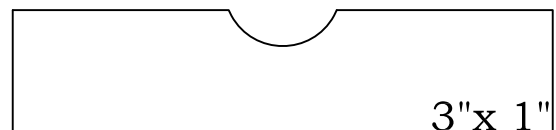

Speciality products

Dovetail drawers

Notch for slides

N1

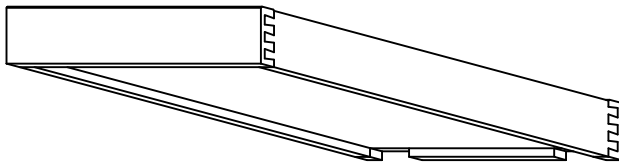

*Notches in back only
w/out holes*



N2

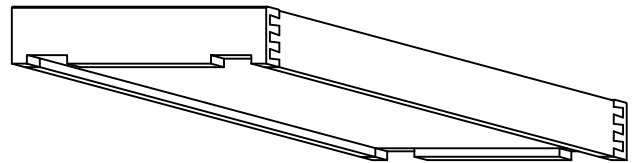

*Notches in back & front
w/out holes*



T1

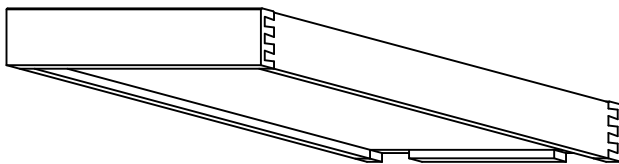

*Notches in back only
w/holes*

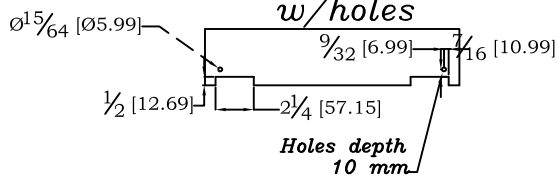

T2

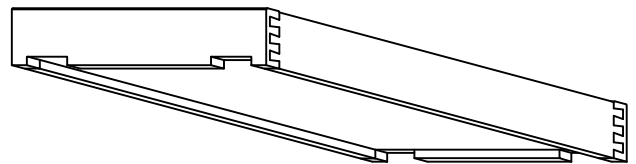

*Back
w/holes*

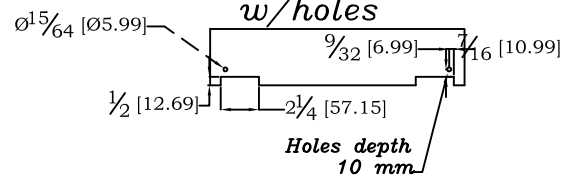

*Front
w/out holes*



Notch for slides

N1

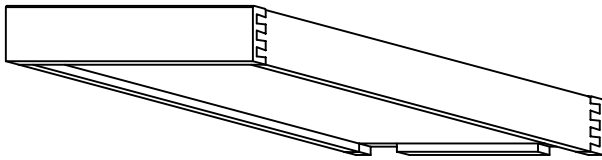

*Notches in back only
w/out holes*



N2

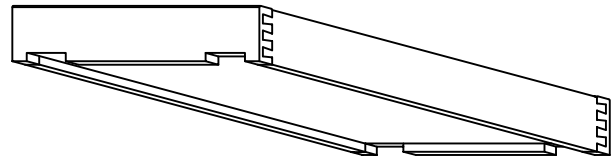

*Notches in back & front
w/out holes*

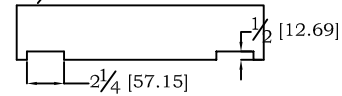

T1

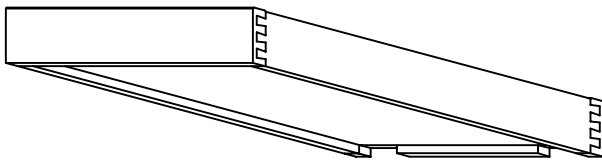

*Notches in back only
w/holes*

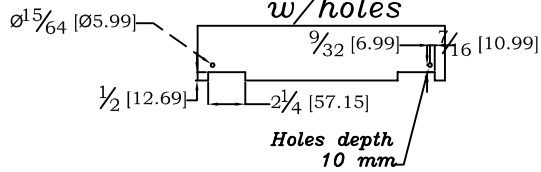

T2

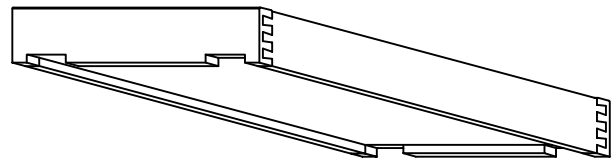

*Back
w/holes*

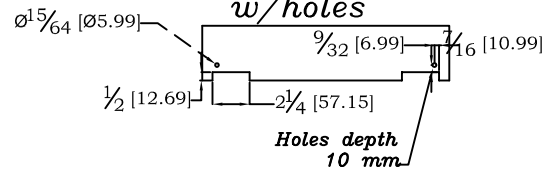

*Front
w/out holes*



TIRBP9/??

Bread box

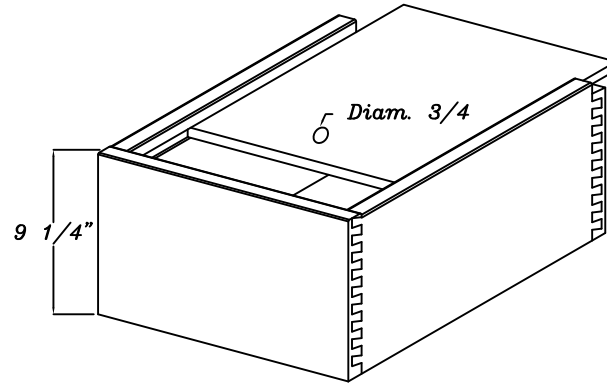

OPTIONS

?	Width
?	Depth

Always 9 1/4" high.

TIRBP10/??

Bread box

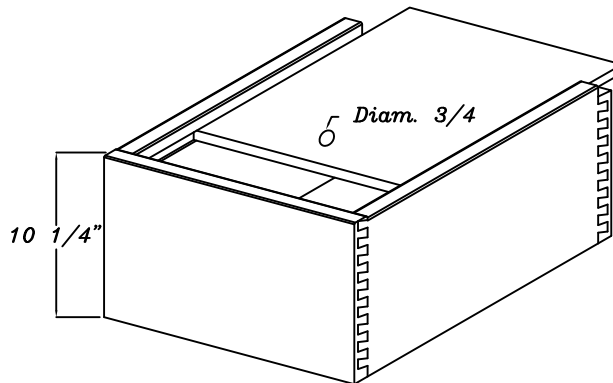

OPTIONS

?	Width
?	Depth

Always 10 1/4" high.

TIRBP11/??

Bread box

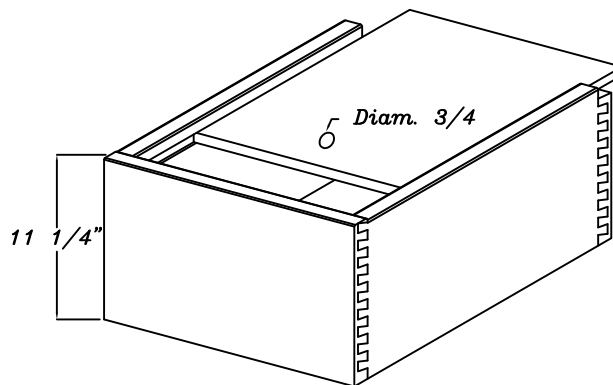

OPTIONS

?	Width
?	Depth

Always 11 1/4" high.

Plumbing notch

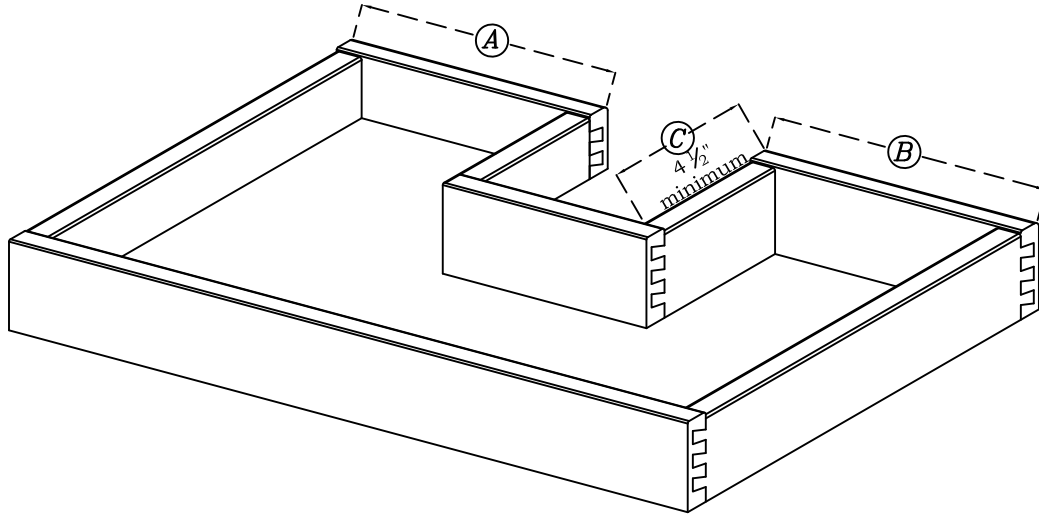

Send us your drawing with the necessary specifications

DCOA/??

Always 4" high.

Dovetail drawers with removable dividers

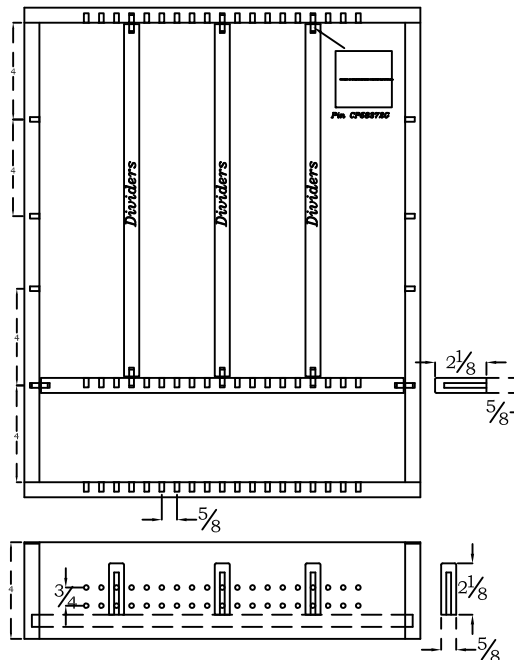

OPTIONS

?	Width
?	Depth

Speciality products

Dovetail drawers

DCOB/???

Always 4" high.

Dovetail drawers with removable dividers

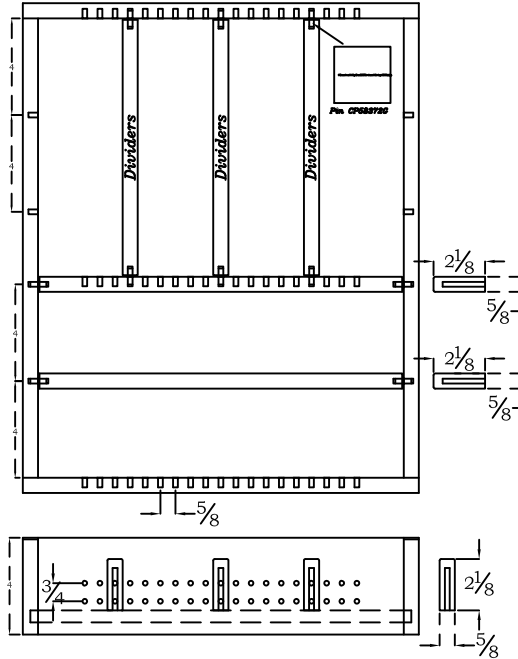

OPTIONS

?	Width
?	Depth

DCOC/???

Always 4" high.

Dovetail drawers with removable dividers

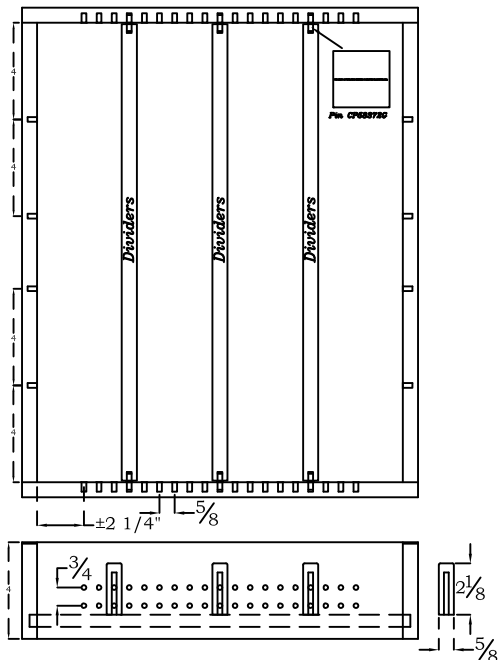

OPTIONS

?	Width
?	Depth

Charter

For DCOA, DCOB and DCOC
quantity of dividers

<i>Drawer Width</i>	<i>Qty of dividers</i>
<i>From 7 $\frac{3}{8}$" to 10 $\frac{3}{8}$"</i>	<i>1</i>
<i>From 10 $\frac{7}{16}$" to 16 $\frac{5}{16}$"</i>	<i>2</i>
<i>From 16 $\frac{3}{8}$" to 19 $\frac{3}{8}$"</i>	<i>3</i>
<i>From 19 $\frac{7}{16}$" to 22 $\frac{5}{16}$"</i>	<i>4</i>
<i>From 22 $\frac{3}{8}$" to 28 $\frac{3}{8}$"</i>	<i>5</i>
<i>From 28 $\frac{7}{16}$" to 31 $\frac{5}{16}$"</i>	<i>6</i>
<i>From 31 $\frac{3}{8}$" to 34 $\frac{5}{16}$"</i>	<i>7</i>
<i>From 34 $\frac{3}{8}$" et +</i>	<i>8</i>

PLA01

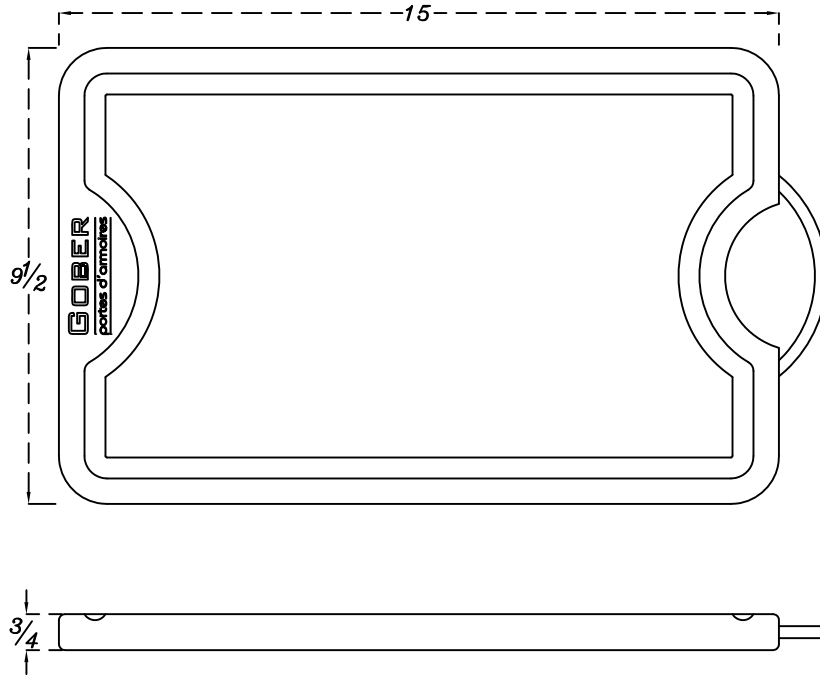

PLA02/ (A) (B)

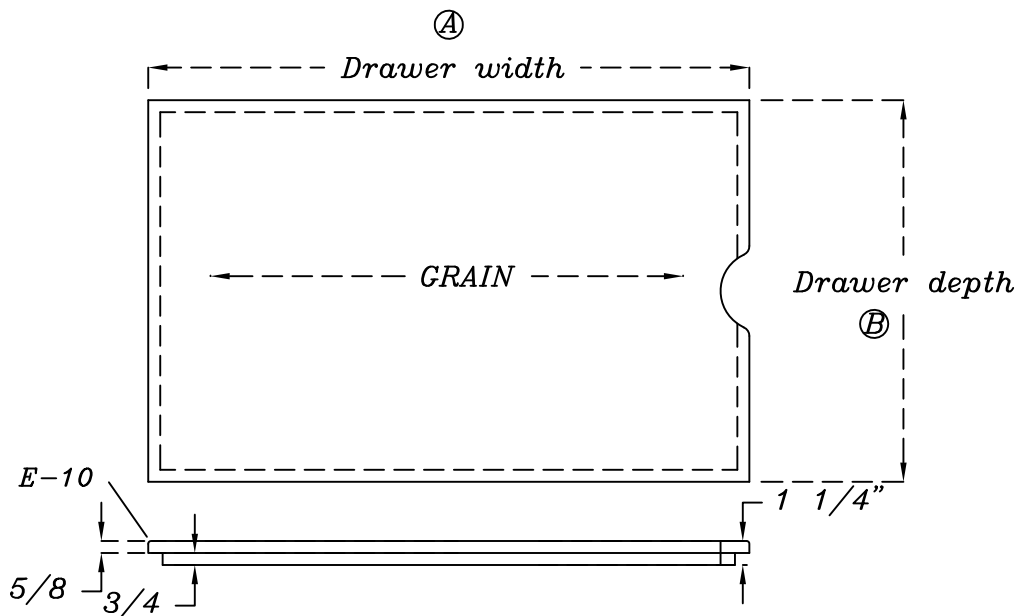

Cutting board adjusts on top of a drawer

Promotional items

Cutting board

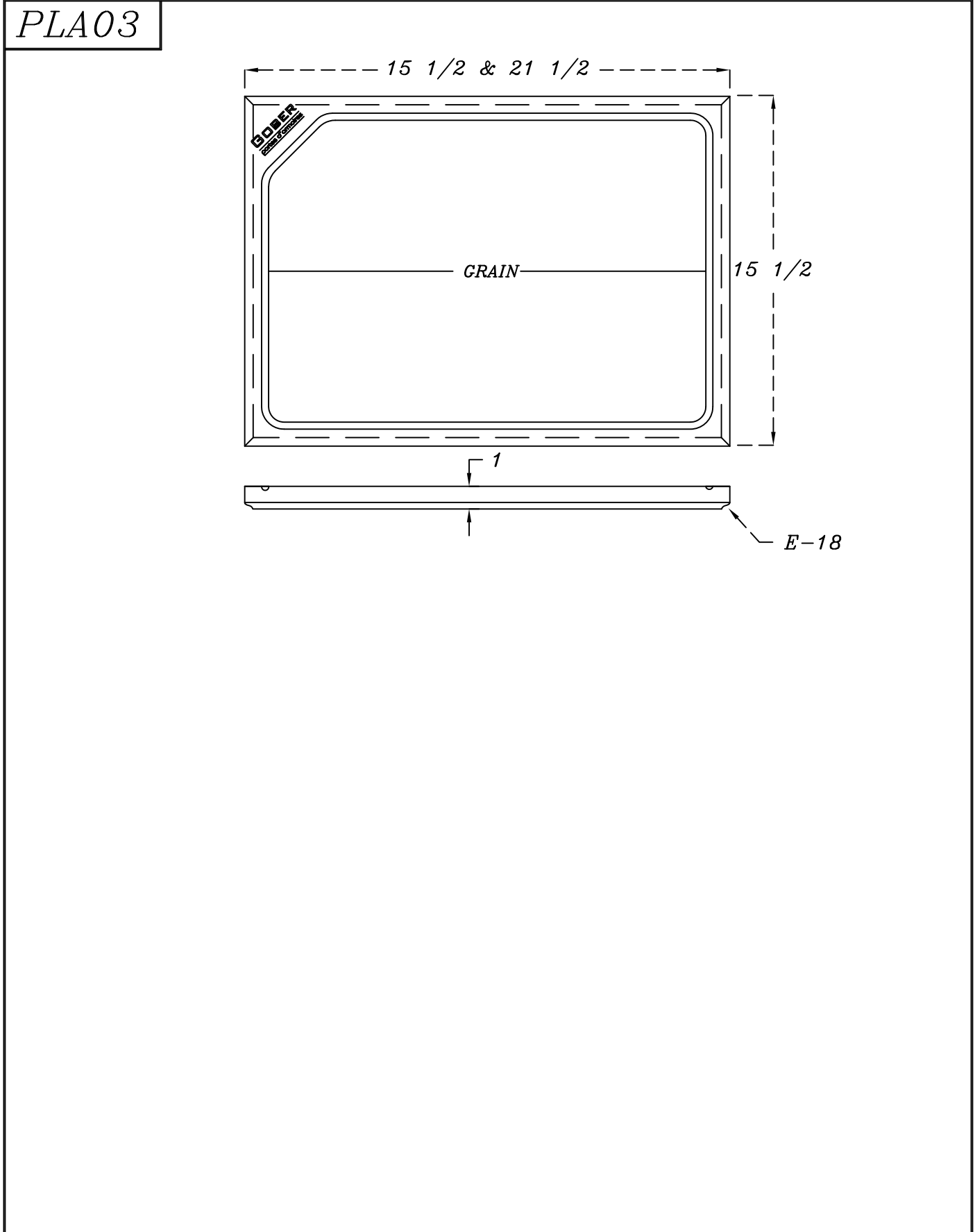

History of the Company

Founded in 1988, Gober has a long and varied history as a manufacturer of solid wood cupboard doors and furniture. Building upon its past experiences, which have included producing everything from custom-made furniture and kitchen cupboards to laminate paneling and mouldings, its focus today is the manufacturing of cupboard doors.

Business Hours

We are opened from Monday to Thursday from 7:30am to 4:30pm, and Friday from 7:30am to 12:00pm. Our receptionist will gladly answer you and direct you towards the right staff member depending on your needs. You can send us your orders, quotes, or any other documents, by email or by fax, 24 hours a day, 7 days a week. Here are our contact information:

Toll Free: (866) 616-7066

Local: (819) 849-7066

Fax: (819) 849-9177

Email: info@gober.ca

Customer Service (Quotes and Orders)

We reserve a delay of approximately 4 hours to do your quote and to send it back to you with a shipping date.

Following approval of the regular order, customers have up to 24 hours to make a change on their orders. The customer will have to pay extra charge after the period mentioned, and this will result in an extension of the deadline.

Example: Approval Monday 3:00pm – Change before Tuesday 3:00pm

Shipping Service

Gober has a policy of offering the best delays according to your needs, and this, with the following wood species: cherry, oak, maple, white birch, and red birch.

For all other wood species, a verification will have to be made beforehand for the availability.

GOBER

cabinet doors

Wood species

Lead time	
1	Regular delivery delay 6 to 8 days
2	Delivery lead time upon wood species availability 10 to 15 days
---	Not available

Grades of wood	
A	Regular price
B	Additional discount – 10 %
C	Additional discount – 20 %
S	Surcharge + 20 %
RUSTIC	Regular price list

#	Wood species	Solid panel	V-01 to V-03	V-05 to V-07	Grade			
					A	B	C	Rustic
1	Maple	1	1	1	1	1	1	2
2	White birch	1	1	1	1	1	1	2
3	Cherry	1	1	1	1	1	1	2
4	Red oak	1	1	1	1	1	1	2
5	Knotty pine	2	2	---	---	---	---	2
6	Clear pine	2	2	---	2	---	---	---
7	White oak	2	2	---	2	---	---	---
8	Hickory	2	2	---	2	---	---	2
9	Red birch	2	2	---	2	---	---	---
10	African mahogany	2	2	---	2	---	---	---
11	Alder	2	2	---	2	---	---	2
12	Black walnut	2	2	---	2	2	---	---
14	Ash	2	2	---	2	---	---	---
15	Beech	2	---	---	2	---	---	---
16	poplar	2	2	---	2	---	---	---
17	White oak rift cut	2	2	---	2	---	---	---
18	Red oak rift cut	2	2	---	2	---	---	---

Returns / Replacements

In order to improve our products, we require a detailed description along with a picture when a piece and/or an order is returned. Pieces should be kept for verification with your number of reference on the product which will be examined by a representative during his next visit. If this step is not done according to our requirements, we will charge you for the defective items.

Our factory is equipped with a system of humidity control that ranges between 40% and 45%. If you do not have control over humidity, we ask you to unwrap the products only a few hours before finishing. In a case where you absolutely need to unwrap the products, we suggest that you cover the pieces with a plastic wrap (polythene sheet) until finishing. This will prevent the changing warp of the doors, the splitting, and the variations in door width.

We will not be able to guarantee our products if the humidity in your factory is not between 35% and 45% and if the products have been left to their natural state (without any protective coating) over 10 days after the shipping date.

Policy for Receiving Goods

Upon receiving a shipment, please be sure to inspect for any signs of damage that may have occurred during shipping. If there are any signs of damage, please notify the driver and request that an inspection be done at the scene. If you suspect that there is damage, please write DAMAGED on the bill of lading.

When it comes to the reception of products wrapped in boxes, you will also have to open the box in front of the delivery man, even though everything might look fine from the exterior. The same procedure will apply if you discover any damages, as said in the previous paragraph.

It will also be very important to validate the number of packages or pallets indicated on the delivery slip versus what you received. What we mean is; if it is written 2 pallets and two packages, you will have to balance with the pieces that you have in hand.

Finally, if you notice damage or if you are missing a package, you will be able to contact us in the next 24 hours. This will give us a chance to contact our freight company and ask for a compensation for the damaged goods.

To conclude, if the damage or the missing item or items has not been reported on the delivery slip, Gober inc. will no longer be held responsible for the replacement of the product at no charge.

Doors with a veneer center are not guaranteed against the shading off of color that could occur between the panel and the stiles and rails in hard wood. The veneer will not absorb the wiping stain the same way as the solid wood. The shifting of the solid wood and veneer is not considered to be damaged. The use of spray stain is recommended for more consistence.

SANDING READY FOR FINISHING

We believe our sanding to be ready for finishing. However, we strongly suggest you to re-sand our products according to your own methods, so you can reach your degree of satisfaction.

Gober is not responsible for the quality of your finishing products. Therefore, we encourage you to make a *preliminary finishing test* before applying the finishing on our products.

WARRANTY

All Gober products come with a warranty against manufacturing defects for a period of two years.

Our warranty does not cover any aspect of the installation, the finishing, the delivery charges, or delivery time. This two-year warranty does not cover damages incurred from improper handling. A 40% humidity level is recommended. Gober is not accountable for any finishing product.

We believe that the quality of our customer service is as important as the quality of our product. In the event that, in spite of our best efforts, a defective product is delivered to you, we promise to repair or replace it as soon as possible.

Gober reserves the right to determine whether damage or a flaw is a manufacturing defect. If, after inspection by our representative, it is proven to be our responsibility, we will repair or replace the merchandise as soon as possible.

The relevant standards for door warping are the following:

- Doors that range from 15 to 30 inches have a tolerance of 1/8 inches.
- Doors that range from 30 1/16 to 48 inches have a tolerance of 3/16 inches.
- Doors that range from 48 1/6 inches and more have a tolerance of 1/14 inches.

All components with a width of more than 24 inches must be ordered with a central post for the warranty to be valid.

Doors exceeding 50 inches in height, ordered without a central rail, are not covered by our warranty. Adding a central rail gives you greater stability. A door with a height of more than 50 inches can be produced without a center rail, but no warranty will be applicable in this case.

Components with a 45° assembly allow a 0.010 in. (.254 mm) joint gap wood expansion.

Take note that there is no warranty on joints for opaque finishes. Mitered doors do not come with a warranty against joint division that occurred because of a high level of humidity or a humid environment. *Opaque finishes or paints are not recommended on mitered doors.* Therefore, we recommend a 5 piece model in MDF.

Handling

Freight charges will be free of charge for any customer that has a delivery of over 1000\$ Canadian before taxes. This applies for all customers residing in the regions of Montreal, Quebec City, Ottawa, Eastern Townships, Center of Quebec, Outaouais, Beauce, and Mauricie.

For all other regions and for all the deliveries in the United States, Gober will pay 5% of the total invoicing in freight charges. This deal is applicable for the same delivery, and this, at the same address.

Example: Invoices: $10\ 000 \$ \times 5 \% = 500\$$ maximum amount paid by Gober on freight charges. You will be charged the difference if applicable.

To prevent any damages during handling, additional charges will be applicable for the packaging of pieces that exceed the standard sizes of our pallets.

If at reception the merchandise is damaged, it is the responsibility of the customer to specify on the delivery slip: damaged merchandise.

Payment Policy

For the first order, (if the opening of an account has not been completed and approved) 50% must be paid before production begins, and the total balance must be paid before delivery by certified cheque, VISA, or Mastercard.

You may request to open an account with our credit service, which will establish the conditions of payment. If this procedure has not been completed for previous orders, the same conditions will apply: 50% must be paid before production begins and the total balance must be paid before delivery by certified cheque, VISA, or Mastercard.

Since all of our accounts are insured, it is possible that the insurance company contacts you and requests certain documents before your account is opened.

You will be able to obtain a 2% discount when a payment by cheque is made on the 10th day following the delivery date. Otherwise, it will be net 30 days, which means that we should have received the cheque on the 30th day after the delivery date.

Any breach of this policy could lead to the stopping of any order in production without any notification and/or administrative charges.

For any delay in the payment of your invoices, we ask you to communicate with our department of accounts receivable.

GOBER

cabinet doors

80, avenue de la Gravière
Coaticook, Qc, Canada J1A 3E6

Tel: (819) 849-7066
T.F.: (866) 616-7066
Fax: (819) 849-9177
info@gober.ca

QUOTE
E33374

Date: 23/09/2013
Page: 1

Billed to: 8197778888

Shipped to: 8197778888

KITCHEN WOODWORK
3, INDUSTRIEL AVE
NEPEAN, ON, CANADA
H0H 0H0

KITCHEN WOODWORK
3, INDUSTRIEL AVE
NEPEAN, ON, CANADA
H0H 0H0

If this quote is confirmed within 24 hours (1 day) following its reception, and no change is made, it will be ship on : **03/10/2013** (can vary from 1 day)

FAX : (819) 777-8889

Salesman: ALAIN ROUTHIER	Your order #: LACOSTE	Freight:	Global Tag:
-----------------------------	--------------------------	----------	-------------

Model	Width	x Height	Description / Species	Bead	Int	Ext	Qty ord.	Unit Price	Dis*	Net Ft. Unit	Total
500	12	x 60	DOOR - BIRCH	CCCC	V-01	E-04	2UN	56.63	*	53.80	107.60
STILES = 2 1/4 & RAILS = 2 1/4 CENT RAIL=C											
501	12	x 6	DRAWER- BIRCH	CCCC	V-01	E-01	1UN	11.33	*	10.76	10.76
STILES = 2 1/4 & RAILS = 1 9/16											
505	12	x 48	FRAME - BIRCH	CCCC	N/A	E-04	1UN	91.06	*	86.51	86.51
8 LITES=2 X 4 SIZE OF THE GLASS 8 3/16 X 44 3/16 Tolerance between 1/16 et 1/8											
SEE DRAWING FOR SPECIAL MULLION											
VL03	45	x 6	VALANCE BIRCH	*1	S-B						
GRADE B											
CRW05	MOULDING DM/CRW05		9' BIRCH	N/A			1MEX	23.59	*	22.41	22.41

TAKE A SPECIAL CARE FOR EVERY DETAILS IN THE BOXES

* Discount of : 5.00 Total unit: 6

Please approve present quote. Production of your order will begin upon receipt of this document duly completed and signed.

accepted without corrections

corrections to do quote return for approval

corrections to do put into production without approval

10.80
0.00

Signature _____

Sub-total: 268.09*

* Taxes and freight not included

1 PROFILES
2 TRADITIONAL 90
3 DISTINCTIVE 90
4 CATHEDRAL 90
5 APPLIED MOULDINGS
6 PRESTIGE 45
7 WANNSCOTS
8 SPECIALTY PRODUCTS
9 MOULDINGS
10 PROMOTIONAL ITEMS
11 POLICY

GOBER

cabinet doors

Département de crédit / Credit department

Téléphone : (819) 849-7066 Télécopieur : (819) 849-9177

payable@gober.ca

AUTORISATION D'ENQUÊTE DE CRÉDIT

Par la présente, notre compagnie : _____

Située au : _____

Signature : _____

Titre : _____ Date : _____

Autorise la compagnie Meubles Gober Inc. à effectuer les enquêtes de crédit auprès des fournisseurs et de la banque mentionnés dans l'ouverture de compte.

CREDIT REFERENCE AUTHORIZATION

We authorize the company : Meubles Gober Inc. to inquire references with the bank and suppliers as detailed on the application.

By the presence our company : _____

Address : _____

Signature : _____

Title : _____ Date : _____

- 1 PROFILES
- 2 TRADITIONAL 90
- 3 DISTINCTIVE 90
- 4 CATHEDRAL 90
- 5 APPLIED MOULDINGS
- 6 PRESTIGE 45
- 7 WAINSCOTS
- 8 SPECIALTY PRODUCTS
- 9 MOULDINGS
- 10 PROMOTIONAL ITEMS
- 11 POLICY



CREDIT APPLICATION

80 Avenue De La Gravière
 Coaticook, Quebec, Canada J1A 3E6
 Tel: (819) 849-7066 Fax: (819) 849-9177
 www.gober.ca payable@gober.ca

Date: _____

Legal name of the company : _____

Is it : INC _____ LTD _____ OTHER _____

Commercial name : _____

Billing address : _____

City : _____ State : _____ Zip Code : _____

Shipping address : _____

City : _____ State : _____ Zip Code : _____

Phone number : (____) _____ - _____ and/or (____) _____ - _____

Fax number : (____) _____ - _____ and/or (____) _____ - _____

E-Mail : _____

Web site : _____

How long in business : _____ GST or IRS No : _____

Accounts payable contact : _____ Phone: (____) _____ - _____

Name of owners : _____

Name & address of the bank : _____

City : _____ State : _____

Account # : _____ Phone : (____) _____ - _____ Fax : (____) _____ - _____

Credit limit required by month : \$ _____

(Your credit limit will be controlled by our credit service and our terms of payment are N/30 days)

Indicate below three (3) credit references with whom you are presently doing business:

1- _____ Phone : (____) _____ - _____ Fax : (____) _____ - _____

2- _____ Phone : (____) _____ - _____ Fax : (____) _____ - _____

3- _____ Phone : (____) _____ - _____ Fax : (____) _____ - _____

Signature _____ Print name _____ Function _____

GOBER

cabinet doors

I herewith authorize, Meubles Gober Inc., to withhold from my credit card, payment of all my future invoices. Since I may not personally present my VISA card or MASTERCARD to Meubles Gober Inc., the necessary information is being transmitted to them :

VISA MASTERCARD

Card # = _____

Expiry date = Month ____ Year ____

Name of the cardholder = _____

Address of the cardholder = _____

Telephone # of the cardholder = (_____) _____ - _____

The 4-digit bin number slightly above or below the embossed card number = _____

I demand to Meubles Gober Inc. that a copy of the VISA or MASTERCARD slip be attached to the corresponding invoice.

For Customs: IRS _____ or Social Security _____

Authorized by : _____ (printing character)

Your title and/or occupation for the company : _____

Name of your company : _____

Telephone : _____

Authorized this _____ day of _____ 201__

Signature : _____

1	PROFILES
2	TRADITIONAL 90
3	DISTINCTIVE 90
4	CATHEDRAL 90
5	APPLIED MOULDINGS
6	PRESTIGE 45
7	WAINSCOTS
8	SPECIALTY PRODUCTS
9	MOULDINGS
10	PROMOTIONAL ITEMS
11	POLICY

